

can-am
OUTLANDER™ X™ mr

**NO
N
N
N**

OPERATOR'S GUIDE

Includes
Safety, Vehicle and
Maintenance Information

⚠ WARNING

Read this guide thoroughly.
It contains important safety information.
Minimum recommended age: Operator: 16 years old.
Keep this Operator's Guide in the vehicle.

2 1 9 0 0 2 1 3 9

Original Instructions

WARNING

YOUR VEHICLE CAN BE HAZARDOUS TO OPERATE. A collision or rollover can occur quickly, if you fail to take proper precautions, even during routine maneuvers such as turning and driving on hills or over obstacles. For your safety, understand and follow all the warnings contained in this Operator's Guide and on the labels on your vehicle. **Failure to follow these warnings can result in SEVERE INJURY OR DEATH!** Keep this Operator's Guide with the vehicle at all times.

WARNING

Disregarding any of the safety precautions and instructions contained in this Operator's Guide, *SAFETY VIDEO* and on-product safety labels could result in an injury including the possibility of death!

WARNING

This vehicle may exceed the performance of other vehicles you may have ridden in the past. Take time to familiarize yourself with your new vehicle.

CALIFORNIA PROPOSITION 65 WARNING

 **WARNING:** Operating, servicing and maintaining an off-road vehicle can expose you to chemicals including engine exhaust, carbon monoxide, phthalates, and lead, which are known to the State of California to cause cancer and birth defects or other reproductive harm. To minimize exposure, avoid breathing exhaust, do not idle the engine except as necessary, service your vehicle in a well-ventilated area and wear gloves or wash your hands frequently when servicing your vehicle. For more information go to www.p65warnings.ca.gov/products/passenger-vehicle.

In Canada, products are distributed by Bombardier Recreational Products Inc. (BRP).

In USA, products are distributed by BRP US Inc.

The following trademarks are the property of Bombardier Recreational Products Inc.:

Can-Am®	DPS™	Rotax®	X™
D.E.S.S.™	Outlander™	TTI™	XPST™

This document contains the trademark of the following companies:

- Visco-Lok[†] is a trademark of GKN Viscodrive GmbH.
- QS3[†] is a trademark of Fox Factory, Inc.

Deutsch	Dieses Handbuch ist möglicherweise in Ihrer Landessprache verfügbar. Bitte wenden Sie sich an Ihren Händler oder besuchen Sie: www.operatorsguides.brp.com
English	This guide may be available in your language. Check with your dealer or go to: www.operatorsguides.brp.com
Español	Es posible que este manual esté disponible en su idioma. Consulte a su distribuidor o visite: www.operatorsguides.brp.com
Français	Ce guide peut être disponible dans votre langue. Vérifier avec votre concessionnaire ou aller à: www.operatorsguides.brp.com
Italiano	Questa guida potrebbe essere disponibile nella propria lingua. Contattare il concessionario o consultare: www.operatorsguides.brp.com
中文	本手册可能有您的语种的翻译版本。请向经销商询问，或者登录 www.operatorsguides.brp.com 查询。
日本語	このガイドは、言語によって翻訳版が用意されています。ディーラーに問い合わせるか、次のアドレスでご確認ください： www.operatorsguides.brp.com
Nederlands	Deze handleiding kan beschikbaar zijn in uw taal. Vraag het aan uw dealer of ga naar: www.operatorsguides.brp.com
Norsk	Denne boken kan finnes tilgjengelig på ditt eget språk. Kontakt din forhandler eller gå til: www.operatorsguides.brp.com
Português	Este manual pode estar disponível em seu idioma. Fale com sua concessionária ou visite o site: www.operatorsguides.brp.com
Русский	Воспользуйтесь руководством на вашем языке. Узнайте о его наличии у дилера или на странице по адресу www.operatorsguides.brp.com
Suomi	Käyttöohjekirja voi olla saatavissa omalla kielelläsi. Tarkista jälleenmyyjältä tai käy osoitteessa: www.operatorsguides.brp.com
Svenska	Denna bok kan finnas tillgänglig på ditt språk. Kontakta din återförsäljare eller gå till: www.operatorsguides.brp.com

This operator's guide covers the following models:

MODELS
Outlander X mr 570 Outlander X mr 650 Outlander X mr 850 Outlander X mr 1000R

TABLE OF CONTENTS

GENERAL INFORMATION

FOREWORD	7
Know Before you Go	7
Safety Messages	7
About This Operator's Guide	7

SAFETY INFORMATION

GENERAL PRECAUTIONS	11
Avoid Carbon Monoxide Poisoning	11
Avoid Gasoline Fires and Other Hazards	11
Avoid Burns from Hot Parts	11
Accessories and Modifications	11
SPECIAL SAFETY MESSAGES	13
Training Course	14
OPERATION WARNINGS	16
RIDING THE VEHICLE	42
Pre-Ride Inspection	43
Riding Gear	46
Carrying a Passenger is Prohibited	46
Carrying Loads	47
Loading the Cargo Rack	47
Hauling a Load (if Equipped with Hitch)	48
Pulling a Trailer (if Equipped with Hitch)	48
Working with your Vehicle	49
Recreational Riding	49
Mud Riding	50
Environment	50
Design Limitation	51
Off-Road Operation	51
General Operating and Safety Precautions	51
Riding Techniques	53
IMPORTANT ON-PRODUCT LABELS (CANADA/UNITED STATES)	60
Hang Tags	60
Vehicle Safety Labels	62
Compliance Labels	67
Technical Information Label	68
IMPORTANT ON-PRODUCT LABELS (ALL COUNTRIES EXCEPT CANADA/UNITED STATES)	69
Vehicle Safety Labels	69
Compliance Labels	75
Technical Information Label	75

REPORTING SAFETY DEFECTS	76
VEHICLE INFORMATION	
PRIMARY CONTROLS	79
1) Handlebar	79
2) Throttle Lever	80
3) Brake Pedal	80
4) Engine Stop Switch	80
5) Brake Lever	81
6) Parking Brake Lever	81
7) Ignition Switch and RF D.E.S.S. Keys	82
SECONDARY CONTROLS	84
1) Throttle Lever Control Housing	85
2) Shift Lever	87
3) Multifunction Switch	88
EQUIPMENTS	91
1) Footpegs	92
2) Mud Riding Footrests	93
3) Glove Box	93
4) Tool kit	94
5) Trailer Hitch	94
6) Rear Storage Compartment	95
7) Cargo Rack	96
8) Seat	96
9) 12-Volt Power Outlet	96
10) Gauge Support	97
11) Radiator Cover	97
12) Winch (If Equipped)	98
13) Recovery Hooks	98
MULTIFUNCTION GAUGE (LCD)	100
Multifunction Gauge Description	100
Multifunction Gauge Modes	102
Navigating in the LCD Gauge	103
Gauge Setup	104
4.5" DIGITAL DISPLAY	106
Multifunction Display	106
Warning Lamps and Indicators	108
Settings	109
7.6" DIGITAL DISPLAY	111
Multifunction Display	111
Warning Lamps and Indicators	113
Settings	115
FUEL	117
Fuel Requirements	117
Fueling Procedure	117

BREAK-IN PERIOD **119**
 Operation During Break-In 119

BASIC PROCEDURES **120**
 Starting the Engine 120
 Waking Up the Electrical System 120
 Changing Gear Selection 120
 Stopping the Engine and Parking the Vehicle 121

SPECIAL PROCEDURES **122**
 What to Do if Water Entered the CVT 122
 What to Do if Water Entered the Air Filter Housing 122
 What to Do if Vehicle is Turned Over 123
 What to Do if Vehicle is Immersed in Water 123

TUNE YOUR RIDE **125**
 Suspension Adjustment 125
 Spring Preload Adjustment 126
 Dynamic Power Steering (DPS) Assist Level Adjustment 126

TRANSPORTING THE VEHICLE **128**
 Using Vehicle Power to Climb onto Trailering Equipment 128
 Using a Winch to Pull Vehicle onto Trailering Equipment 129
 Securing vehicle for transport 130
 Getting vehicle out of trailer 130

MAINTENANCE

MAINTENANCE SCHEDULE **133**
 SEVERE DUSTY CONDITIONS 134
 MAINTENANCE SCHEDULE LEGEND 134
 MAINTENANCE SCHEDULE 134

MAINTENANCE PROCEDURES **137**
 Air Filter 137
 Engine Oil 140
 Oil Filter 142
 Radiator 142
 Engine Coolant 143
 Muffler Spark Arrester 145
 CVT Air Filter 147
 Gearbox Oil 147
 Throttle Cable 149
 Spark Plugs 151
 CVT Cover 152
 CVT Cover Installation 152
 Drive Belt 153
 Battery 154
 Fuses 154
 Lights (570 Models) 157
 Lights (650, 850 and 1000R Models) 157

MAINTENANCE PROCEDURES (cont'd)

Drive Shaft Bellow and Protector 159

Wheels and Tires 160

Suspension 161

Steering 162

Brakes..... 162

VEHICLE CARE 164

Post-Operation Care 164

Vehicle Cleaning and Protection 164

STORAGE AND PRESEASON PREPARATION 166

TECHNICAL INFORMATION

VEHICLE IDENTIFICATION 169

Vehicle Identification Number..... 169

Engine Identification Number 169

Compliance Label 169

Radio Frequency Digitally Encoded Security System (RF D.E.S.S. key) .. 170

NOISE EMISSION CONTROL SYSTEM REGULATION (CANADA/UNITED STATES)..... 171

NOISE EMISSION AND VIBRATION VALUES (ALL COUNTRIES EXCEPT CANADA/UNITED STATES)..... 172

EC-DECLARATION OF CONFORMITY 173

EAC DECLARATION OF CONFORMITY 174

SPECIFICATIONS 175

TROUBLESHOOTING

TROUBLESHOOTING GUIDELINES 185

ANALOG/DIGITAL GAUGE MESSAGES 190

WARRANTY

BRP LIMITED WARRANTY USA AND CANADA: 2021 CAN-AM® ATV 193

US EPA EMISSION-RELATED WARRANTY 196

BRP INTERNATIONAL LIMITED WARRANTY: 2021 CAN-AM® ATV 199

BRP LIMITED WARRANTY FOR THE EUROPEAN ECONOMIC AREA, THE COMMONWEALTH OF THE INDEPENDENT STATES AND TURKEY: 2021 CAN-AM® ATV 203

MAINTENANCE RECORDS 208

CUSTOMER INFORMATION

PRIVACY INFORMATION **213**

CONTACT US..... **214**

 Asia..... 214

 Europe 214

 North America 214

 Oceania 214

 South America..... 214

CHANGE OF ADDRESS/OWNERSHIP..... **215**

GENERAL INFORMATION

FOREWORD

Congratulations on your purchase of a new Can-Am® ATV. It's backed by the BRP limited warranty and a network of authorized Can-Am dealers ready to provide the parts, accessories or service you may require.

At delivery, you were informed of the warranty coverage and signed the *PRE-DELIVERY CHECK LIST* to ensure your new vehicle was prepared to your entire satisfaction.

Your dealer is committed to your satisfaction. If you need more information, please ask your dealer.

Know Before you Go

To learn how to reduce the risk for you or bystanders being injured or killed, read this Operator's Guide before you operate the vehicle.

Also, read all safety labels on your ATV and watch attentively the *SAFETY VIDEO* located at <https://can-am.brp.com/off-road/safety>.



This vehicle is a category S, always follow this age recommendation: A person under 16 years old should never operate this vehicle.

This vehicle is for recreational use by experienced operators only.

We highly recommend that you take a safety riding course. Refer to *SPECIAL SAFETY MESSAGES* for details.

Failure to follow the warnings contained in this Operator's Guide can result in SERIOUS INJURY or DEATH.

Safety Messages

The types of safety messages, what they look like and how they are used in this guide are explained as follows:

The safety alert symbol  indicates a potential injury hazard.

WARNING

Indicates a potential hazard, if not avoided, could result in serious injury or death.

 CAUTION Indicates a hazard situation which, if not avoided, could result in minor or moderate injury.

NOTICE Indicates an instruction which, if not followed, could severely damage vehicle components or other property.

About This Operator's Guide

This Operator's Guide has been prepared to acquaint the owner/operator of a new vehicle with the various vehicle controls, maintenance and safe operating instructions. It is indispensable for the proper use of the product.

Keep this Operator's Guide in the vehicle as you can refer to it for things such as maintenance, troubleshooting and instructing others.

Note that this guide is available in several languages. In the event of any discrepancy, the english version shall prevail.

If you want to view and/or print an extra copy of your Operator's Guide, simply visit the following website:

www.operatorsguides.brp.com

The informations contained in this document are correct at the time of publication. However, BRP maintains a policy of continuous improvement of its products without imposing upon itself any obligation to install them on products previously manufactured. Due to late changes, some differences between the manufactured product and

the descriptions and/or specifications in this guide may occur. BRP reserves the right at any time to discontinue or change specifications, designs, features, models or equipment without incurring any obligation upon itself.

This Operator's Guide should remain with the vehicle when it is sold.

***This page is
intentionally blank***

SAFETY INFORMATION

GENERAL PRECAUTIONS

Avoid Carbon Monoxide Poisoning

All engine exhaust contains carbon monoxide, a deadly gas. Breathing carbon monoxide can cause headaches, dizziness, drowsiness, nausea, confusion and eventually death.

Carbon monoxide is a colorless, odorless, tasteless gas that may be present even if you do not see or smell any engine exhaust. Deadly levels of carbon monoxide can collect rapidly, and you can quickly be overcome and unable to save yourself. Also, deadly levels of carbon monoxide can linger for hours or days in enclosed or poorly ventilated areas. If you experience any symptoms of carbon monoxide poisoning, leave the area immediately, get fresh air and seek medical treatment.

To prevent serious injury or death from carbon monoxide:

- Never run the vehicle in poorly ventilated or partially enclosed areas such as garages, carports or barns. Even if you try to ventilate engine exhaust with fans or open windows and doors, carbon monoxide can rapidly reach dangerous levels.
- Never run the vehicle outdoors where engine exhaust can be drawn into a building through openings such as windows and doors.

Avoid Gasoline Fires and Other Hazards

Gasoline is extremely flammable and highly explosive. Fuel vapors can spread and be ignited by a spark or flame many feet away from the engine. To reduce the risk of fire or explosion, follow these instructions:

- Use only an approved gasoline container to store fuel.
- Strictly adhere to instructions in *FUEL*.
- Never start or operate the engine if the fuel cap is not properly installed.

Gasoline is poisonous and can cause injury or death.

- Never siphon gasoline by mouth.
- If you swallow gasoline, get any in your eye(s), or inhale gasoline vapor, see your doctor immediately.

If gasoline spills on you, wash with soap and water and change your clothes.

Avoid Burns from Hot Parts

Certain components become hot during operation. Avoid contact with those parts during and shortly after operation to avoid burns.

Accessories and Modifications

Any modifications or addition of accessories may affect the handling of your vehicle. It is important to take the time to get familiar with the vehicle once modifications are made to understand how to adapt your driving behavior accordingly.

While reading this Operator's Guide, remember that:

WARNING

Indicates a potential hazard that, if not avoided, could result in serious injury or death.

Do not tamper with unauthorized modifications or install equipment not specifically certified by BRP for the vehicle. These modifications have not been tested by BRP and they may increase the risk of injury or loss of control, or render the vehicle illegal to ride. As an example, tampering with tire specifications may affect the behavior of the vehicle and increase the risk of a loss of control.

Ask your authorized BRP dealer for suitable available accessories for your vehicle.

SPECIAL SAFETY MESSAGES

THIS VEHICLE IS NOT A TOY AND CAN BE HAZARDOUS TO OPERATE.

- This vehicle handles differently from other vehicles. A collision or rollover can occur quickly, if you fail to take proper precautions, even during routine maneuvers such as turning and driving on hills or over obstacles.

SEVERE INJURY OR DEATH can result if you do not comply with the following instructions:

- Read this Operator's Guide and all on-product safety labels carefully and follow the operating procedures described. Watch and pay attention to the *SAFETY VIDEO* before operating the vehicle.
- Always follow this age recommendation: A person under 16 years old should never operate this vehicle.
- Never carry a passenger on this vehicle. Passenger(s) affect balance and steering and increase risk of losing control.
- Never operate this vehicle on any paved surfaces, including sidewalks, driveways, parking lots and streets.
- Never operate this vehicle on any public street, road or highway, even a dirt or gravel one.
- Never take place on this vehicle without wearing an approved helmet that fits properly. You should also wear eye protection (goggles or face shield), gloves, boots, long sleeved shirt or jacket, and long pants.
- Never use this vehicle if you are tired, ill or with drugs or alcohol. Your reaction time and judgement is greatly affected under these conditions.
- Never operate at excessive speeds. Always go at a speed that is proper for the terrain, visibility, and operating conditions, and your experience.
- Never attempt wheelies, jumps, or other stunts.
- Always inspect and confirm the safe operating condition of your vehicle prior to ride. Always follow the inspection and maintenance procedures and schedules described in this Operator's Guide.
- Always keep both hands on the handlebars and both feet on the footrests of the vehicle during operation.
- Always go slowly and be extra careful when operating on unfamiliar terrain. Always be alert to changing terrain conditions when operating this vehicle.
- Never operate on excessively rough, slippery or loose terrain until you have learned and practiced the skills necessary to control this vehicle on such terrain. Always be especially cautious on these kinds of terrain.
- Always follow proper procedures for turning as described further in this Operator's Guide. Practice turning at low speeds before attempting to turn at faster speeds. Do not turn at excessive speed.
- Never operate this vehicle on hills too steep for the vehicle or for your abilities. Practice on smaller hills before attempting larger hills.
- Always follow proper procedures for climbing hills as described further in this Operator's Guide. Check the terrain carefully before you start up any hill. Never climb hills with excessively slippery or loose surfaces. Shift your weight forward. Never open the throttle suddenly or make sudden gear changes. Never go over the top of any hill at high speed.
- Always follow proper procedures for going down hills and for braking on hills as described further in this Operator's Guide. Check the terrain carefully before you start down any hill. Shift your weight backward.

- Always follow proper procedures for crossing the side of a hill as described further in this Operator's Guide. Avoid hills with excessively slippery or loose surfaces. Shift your weight to the uphill side of the vehicle.
- Always use proper procedures if you stall or roll backwards when climbing a hill. To avoid stalling, use proper range and maintain a steady speed when climbing a hill. If you stall or roll backwards, follow the special procedure for braking described in this Operator's Guide. Apply parking brake, dismount on the uphill side or on the LH side to access the brake lever. Turn the vehicle around and remount, following the procedure described further in this Operator's Guide.
- Always check for obstacles before operating in a new area. Never attempt to operate over large obstacles, such as large rocks or fallen trees. Always follow proper procedures when operating over obstacles as described further in this Operator's Guide.
- Always be careful when skidding or sliding. Learn to safely control skidding or sliding by practicing at low speeds and on level smooth terrain. On extremely slippery surfaces, such as ice, go slowly and be very cautious in order to reduce the chance of skidding out of control.
- Never operate this vehicle in fast flowing water or in water deeper than that specified in this Operator's Guide. Remember that wet brakes may have reduced stopping ability. Test your brakes after leaving water, mud or snow. If necessary, apply them several times to let friction dry out the pads.
- Always keep in mind that braking distance is readily affected by but not limited to; weather and terrain conditions, braking system and tire conditions, vehicle speed and attitude, and vehicle load including towing. Remember to adjust your driving accordingly.
- Always be sure there are no obstacles or people behind the vehicle when you operate in reverse. When it is safe to proceed in reverse, go slowly.
- BRP recommends sitting on your ATV when operating in reverse. Avoid standing up. Your weight could shift forward against throttle lever, causing an unexpected acceleration and loss of control.
- Always use the size and type tires specified further in this Operator's Guide. Always maintain proper tire pressure.
- Never modify this vehicle through improper installation or use of accessories. Only use BRP's approved accessories. NEVER install passenger seat or use the cargo area to carry a passenger.
- Never exceed the stated load limits for this vehicle including operator, all other loads and added accessories. Cargo should be properly distributed and securely attached. Reduce speed and follow instructions in this manual for carrying cargo or pulling a trailer. Allow greater distance for braking.
- Never operate the vehicle if the controls do not function normally.

Training Course

Never operate this vehicle without proper instruction. **Take a training course.** All operators should receive training from a certified instructor.

FOR MORE INFORMATION ABOUT ATV SAFETY, contact an authorized Can-Am dealer to find out about available training courses nearest you.

In the United States, call the Specialty Vehicle Institute of America (SVIA) at 1 800 887-2887 or in Canada, the Canada Safety Council (CSC) at 1 613 739-1535.

While reading this Operator's Guide, remember that:

 **WARNING**

Indicates a potential hazard that, if not avoided, could result in serious injury or death.

OPERATION WARNINGS

The following warning and their format have been requested by the United States Consumer Product Safety Commission and are required to be in the Operator's Guide for all ATVs.

NOTE: The following illustrations are general representations only. Your model may differ.

WARNING



POTENTIAL HAZARD

Operating this vehicle without proper instruction.

WHAT CAN HAPPEN

The risk of an accident is greatly increased if the operator does not know how to operate this vehicle properly in different situations and on different types of terrain.

HOW TO AVOID THE HAZARD

Beginners and inexperienced operators should complete a training course. They should then regularly practice the skills learned during the course as well as the operating techniques described in this Operator's Guide.

For more information about the training course, contact an authorized Can-Am dealer.

⚠ WARNING



V00A1AQ

POTENTIAL HAZARD

Failure to follow the age recommendations for this vehicle.

WHAT CAN HAPPEN

A lack of respect for this age recommendation can lead to severe injury or death of the child.

Even though a child may be within the age group for which this vehicle is recommended, he may not have the skills, abilities, or judgment needed to operate this vehicle safely and may be involved in a serious accident.

HOW TO AVOID THE HAZARD

No one under 16 should operate this vehicle.

⚠ WARNING

V00A02Q

POTENTIAL HAZARD

Carrying a passenger on this vehicle.

WHAT CAN HAPPEN

Greatly reduces your ability to balance and control this vehicle.

Could cause an accident, resulting in harm to you and/or your passenger.

HOW TO AVOID THE HAZARD

Never carry passenger. Even with a long seat that provides unrestricted operator movement, it is not designed nor intended to carry passenger(s).

⚠ WARNING



POTENTIAL HAZARD

Operating this vehicle on paved surfaces.

WHAT CAN HAPPEN

The tires are designed for off-road use only, not for use on pavement. Paved surfaces may seriously affect handling and control of this vehicle, and may cause the vehicle to go out of control.

HOW TO AVOID THE HAZARD

Never operate this vehicle on any paved surfaces, including sidewalks, driveways, parking lots and streets.

⚠ WARNING**POTENTIAL HAZARD**

Operating this vehicle on public streets, roads or highways.

WHAT CAN HAPPEN

You can collide with another vehicle.

HOW TO AVOID THE HAZARD

Never operate this vehicle on any public street, road or highway, even a dirt or gravel one. In many states or provinces it is illegal to operate this vehicle on public streets, roads or highways.

⚠ WARNING



POTENTIAL HAZARD

Riding this vehicle without wearing an approved helmet, eye protection and protective clothing.

WHAT CAN HAPPEN

The following items concern all ATV's operator:

- Riding without an approved helmet increases the chances of a severe head injury or death in the event of an accident.
- Riding without eye protection can result in an accident and increases the chances of a severe injury in the event of an accident.
- Riding without protective clothing increases the chances of severe injury in the event of an accident.

HOW TO AVOID THE HAZARD

Always wear an approved helmet that fits properly. You should also wear:

- Eye protection (goggles or face shield)
- Gloves and boots
- Long sleeved shirt or jacket
- Long pants.

⚠ WARNING

V00A07Q

POTENTIAL HAZARD

Using this vehicle with drugs or alcohol.

WHAT CAN HAPPEN

- Could seriously affect your judgment.
- Could cause you to react more slowly.
- Could affect your balance and perception.
- Could result in an accident or death.

HOW TO AVOID THE HAZARD

Never use this vehicle with drugs or alcohol.

⚠ WARNING

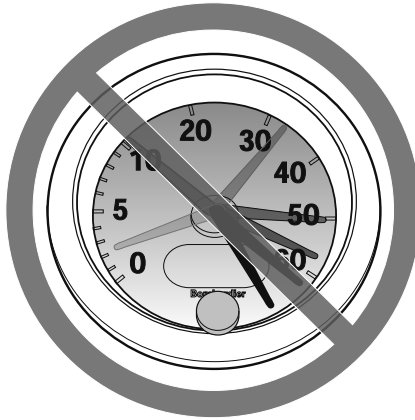

V00A08Q

POTENTIAL HAZARD

Operating this vehicle at excessive speeds.

WHAT CAN HAPPEN

Increases your chances of losing control of the vehicle, which can result in an accident.

HOW TO AVOID THE HAZARD

Always travel at a speed which is appropriate for the terrain, visibility and operating conditions, and your experience.

⚠ WARNING**POTENTIAL HAZARD**

Attempting wheelies, jumps and other stunts.

WHAT CAN HAPPEN

Increases the chance of an accident, including an overturn.

HOW TO AVOID THE HAZARD

Never attempt stunts, such as wheelies or jumps. Do not try to show off.

⚠ WARNING**POTENTIAL HAZARD**

Failure to inspect the vehicle before operating.

Failure to properly maintain the vehicle.

WHAT CAN HAPPEN

Increases the possibility of an accident or equipment damage.

HOW TO AVOID THE HAZARD

Always inspect your vehicle prior to every time you use it to make sure the vehicle is in safe operating condition.

Always follow the inspection and maintenance procedures and schedules described further in this Operator's Guide.

⚠ WARNING

POTENTIAL HAZARD

Riding on frozen waterways.

WHAT CAN HAPPEN

Breaking through the ice can lead to severe injury or death.

HOW TO AVOID THE HAZARD

Never ride this vehicle on a frozen surface before you are sure the ice is thick enough and sound enough to support the vehicle and its load, as well as the force that is created by a moving vehicle.

⚠ WARNING



POTENTIAL HAZARD

Removing hands from handlebar or feet from the footrests during operation.

WHAT CAN HAPPEN

Removing even one hand or foot can reduce your ability to control the vehicle or could cause you to lose your balance and fall off the vehicle. If you remove a foot from the footrests, your foot or leg may come into contact with the rear wheels, which could injure you or cause an accident.

HOW TO AVOID THE HAZARD

Always keep both hands on the handlebar and both feet on the footrests during vehicle operation.

⚠ WARNING**POTENTIAL HAZARD**

Failure to use extra care when operating this vehicle on unfamiliar terrain.

WHAT CAN HAPPEN

You can come upon hidden rocks, bumps, or holes, without enough time to react.

Could result in the vehicle overturning or loss of control.

HOW TO AVOID THE HAZARD

Go slowly and be extra careful when operating on unfamiliar terrain.

Always be alert to changing terrain conditions when operating the vehicle.

⚠ WARNING



POTENTIAL HAZARD

Failure to use extra care when operating on excessively rough, slippery or loose terrain.

WHAT CAN HAPPEN

Could cause loss of traction or vehicle control, which could result in an accident, including an overturn.

HOW TO AVOID THE HAZARD

Do not operate on excessively rough, slippery or loose terrain until you have learned and practiced the skills necessary to control this vehicle on such terrain.

Always be especially cautious on these kinds of terrain.

⚠ WARNING**POTENTIAL HAZARD**

Turning improperly.

WHAT CAN HAPPEN

Vehicle could go out of control, causing a collision or overturn.

HOW TO AVOID THE HAZARD

Always follow proper procedures for turning as described further in this Operator's Guide. Practice turning at low speeds before attempting to turn at faster speeds.

Do not turn at excessive speed.

⚠ WARNING



POTENTIAL HAZARD

Operating on excessively steep hills.

WHAT CAN HAPPEN

The vehicle can overturn more easily on extremely steep hills than on level surfaces or small hills.

HOW TO AVOID THE HAZARD

Never operate this vehicle on hills too steep for the vehicle or for your abilities.

Practice on smaller hills before attempting larger hills.

⚠ WARNING**POTENTIAL HAZARD**

Climbing hills improperly.

WHAT CAN HAPPEN

Could cause loss of control or cause vehicle to overturn.

HOW TO AVOID THE HAZARD

Always follow proper procedures for climbing hills as described further in this Operator's Guide.

Always check the terrain carefully before you start up any hill.

Never climb hills with excessively slippery or loose surfaces.

Shift your weight forward.

Never open the throttle suddenly or make sudden gear changes. The vehicle could flip over backwards.

Never go over the top of any hill at high speed. An obstacle, a sharp drop, or another vehicle or person could be on the other side of the hill.

⚠ WARNING



POTENTIAL HAZARD

Going down a hill improperly.

WHAT CAN HAPPEN

Could cause loss of control or cause vehicle to overturn.

HOW TO AVOID THE HAZARD

Always follow proper procedures for going down hills as described further in this Operator's Guide.

NOTE: A special technique is required when braking as you go down a hill.

Always check the terrain carefully before you start down any hill.

Shift your weight backward.

Never go down a hill at high speed.

Avoid going down a hill at an angle which would cause the vehicle to lean sharply to one side. Go straight down the hill where possible.

⚠ WARNING**POTENTIAL HAZARD**

Improperly crossing hills or turning on hills.

WHAT CAN HAPPEN

Could cause loss of control or cause vehicle to overturn.

HOW TO AVOID THE HAZARD

Never attempt to turn the vehicle around on any hill until you have mastered the turning technique as described further in this Operator's Guide on level ground. Be very careful when turning on any hill.

Avoid crossing the side of a steep hill if possible.

When crossing the side of a hill:

Always follow proper procedures as described further in this Operator's Guide.

Avoid hills with excessively slippery or loose surfaces.

Shift your weight to the uphill side of the vehicle.

⚠ WARNING

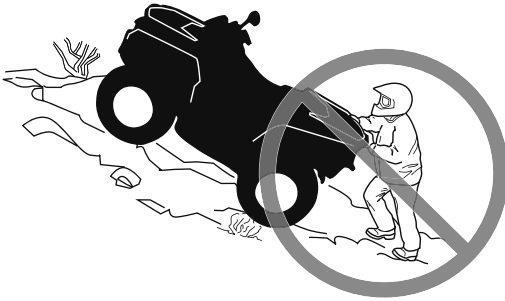

POTENTIAL HAZARD

Stalling, rolling backwards or improperly dismounting while climbing a hill.

WHAT CAN HAPPEN

Could result in vehicle overturning.

HOW TO AVOID THE HAZARD

Use proper range and maintain steady speed when climbing a hill.

If you lose all forward speed:

Keep your weight uphill. Never open the throttle suddenly or make sudden gear changes. The vehicle could flip over backwards.

Apply the brakes.

Lock parking brake after you have stopped.

Dismount on uphill side, or to a side if pointed straight uphill.

If you begin rolling backwards:

Keep your weight uphill. Never open the throttle suddenly or make sudden gear changes. The vehicle could flip over backwards.

Never apply the rear brake while rolling backwards.

Apply the front brake gradually.

When fully stopped, apply rear brake as well and lock parking brake.

Dismount on uphill side, or to a side if pointed straight uphill.

Turn the vehicle around and remount, following the procedure described further in this Operator's Guide.

⚠ WARNING**POTENTIAL HAZARD**

Improperly operating over obstacles.

WHAT CAN HAPPEN

Could cause loss of control or a collision.

Could cause the vehicle to overturn.

HOW TO AVOID THE HAZARD

Before operating in a new area, check for obstacles.

Never attempt to ride over large obstacles, such as large rocks or fallen trees.

When you go over obstacles, always follow proper procedures as described further in this Operator's Guide.

⚠ WARNING



POTENTIAL HAZARD

Skidding or sliding improperly.

WHAT CAN HAPPEN

You may lose control of this vehicle.

You may also regain traction unexpectedly, which may cause the vehicle to overturn.

HOW TO AVOID THE HAZARD

Learn to safely control skidding or sliding by practicing at low speeds and on level smooth terrain.

On extremely slippery surfaces, such as ice, go slowly and be very cautious in order to reduce the chance of skidding or sliding out of control.

⚠ WARNING**POTENTIAL HAZARD**

Operating this vehicle through deep or fast flowing water.

WHAT CAN HAPPEN

Tires may float, causing loss of traction and loss of control, which could lead to an accident.

HOW TO AVOID THE HAZARD

Never operate this vehicle in fast flowing water or in water deeper than that specified further in this Operator's Guide.

Check water depth and current before you attempt to cross any water. Water level should not go above tires.

Remember that wet brakes may have reduced stopping ability. Test your brakes after leaving water. If necessary, apply them several times to let friction dry out the pads.

⚠ WARNING



POTENTIAL HAZARD

Improperly operating in reverse.

WHAT CAN HAPPEN

You could hit an obstacle or person behind the vehicle, resulting in serious injury.

HOW TO AVOID THE HAZARD

When you select reverse gear, make sure there are no obstacles or people behind the vehicle. When it is safe to proceed, go slowly.

⚠ WARNING**POTENTIAL HAZARD**

Operating this vehicle with improper tires, or with improper or uneven tire pressure.

WHAT CAN HAPPEN

Use of improper tires on this vehicle, or operation of this vehicle with improper or uneven tire pressure, may cause loss of control, tire blow outs, tire to move around on its rim and increases the risk of an accident.

HOW TO AVOID THE HAZARD

Always use the size and type of tires specified further in this Operator's Guide for this vehicle.

Always maintain proper tire pressure as described further in this Operator's Guide.

Always replace wheels or tires that are damaged.

⚠ WARNING



POTENTIAL HAZARD

Operating this vehicle with improper modifications.

WHAT CAN HAPPEN

Improper installation of accessories or modification of this vehicle may cause changes in handling which in some situations could lead to an accident.

HOW TO AVOID THE HAZARD

Never modify this vehicle through improper installation or use of accessories. All parts and accessories added to this vehicle should be approved by BRP and should be installed and used according to instructions. If you have questions, consult an authorized Can-Am dealer.

NEVER install passenger seat or use the cargo area to carry a passenger.

Modification of the vehicle to increase speed and performance may violate the terms and conditions of your vehicle's limited warranty. In addition, certain modifications including the removal of engine or exhaust components are illegal under most laws.

⚠ WARNING**POTENTIAL HAZARD**

Overloading this vehicle, carrying or towing cargo improperly.

WHAT CAN HAPPEN

Could cause changes in vehicle handling which could lead to an accident.

HOW TO AVOID THE HAZARD

Never exceed the stated load capacity for this vehicle including operator, as well as other loads and added accessories.

Cargo should be properly distributed and securely attached.

Reduce speed when carrying cargo or pulling a trailer. Allow greater distance for braking.

Always follow the instructions in this Operator's Guide for carrying cargo or pulling a trailer.

⚠ WARNING



V03M01Q

POTENTIAL HAZARD

Transporting flammable or dangerous material can lead to explosions.

WHAT CAN HAPPEN

This can cause serious injury or death.

HOW TO AVOID THE HAZARD

Never transport flammable or dangerous material.

While reading this Operator's Guide, remember that:

⚠ WARNING

Indicates a potential hazard that, if not avoided, could result in serious injury or death.

RIDING THE VEHICLE

To fully appreciate the pleasures and excitement of riding this vehicle, there are some basic rules and tips that you **MUST** follow. Some may be new to you while others may be common sense or obvious.

Please take the time to study this Operator's Guide and all on-product safety labels as well as the *SAFETY VIDEO* that came with this vehicle. They more completely describe what you should know about this vehicle before riding it.

Whether you are a new user or an experienced rider, it is important for your personal safety that you know the controls and features of this vehicle. Equally important is knowing how to properly ride.

This is a high performance ATV for off-road use only. Inexperienced riders may overlook risks and be surprised by the specific behavior of this ATV in any terrain condition.

Information in this Operator's Guide is limited. It is strongly recommended that you obtain further information and training from your local authorities, ATV clubs, a recognized ATV training organization or contact an authorized Can-Am dealer.

We recommend following the age recommendation indicated on the safety label affixed on the unit. Even though a person may be within the age group for which this vehicle is recommended, he may not have the skills, abilities, or judgment needed to operate this vehicle safely and may be involved in a serious accident.

Individuals with cognitive or physical impairments or who are high risk takers have an increased exposure to overturns or collisions which may result in injury including death.

This vehicle is designed specifically to carry an operator only. Even with a long seat that provides unrestricted operator movements, it is not designed nor intended to carry passenger(s).

NEVER install passenger seat or use the cargo area to carry passenger(s). Carrying passenger(s) may affect the stability and your control of the vehicle.

Not all vehicles are the same. Each has its own unique performance characteristics, controls and features. Each will ride and handle differently.

Become completely familiar with the operational controls and the general operation of the vehicle before venturing into off road conditions. Practice driving in a suitable area free of hazards and feel the response of each control. Drive at low speeds. Higher speeds require greater experience, knowledge and suitable riding conditions.

Riding conditions vary from place to place. Each is subject to weather conditions which may radically change from time to time and from season to season.

Riding on sand is different than riding on snow or through forests or marshes. Each location may require a greater degree of awareness and skill. Show good judgement. Always proceed with caution. Please do not take any unnecessary risks that could leave you stranded or possibly injured.

Never assume that the vehicle will go everywhere safely. Sudden changes in terrain caused by holes, depressions, banks, softer or harder "ground" or other irregularities may cause the vehicle to topple or become unstable. To avoid this, slow down and always observe the terrain ahead. If the vehicle does begin to topple or tip over, the best advice is to immediately get off, AWAY from the direction of the tip over!

We encourage you to have an Annual Safety Inspection of your vehicle. Please contact an authorized BRP dealer for further details. Though not required, it is recommended that an authorized BRP dealer performs the preseason preparation of your vehicle. Each visit to your authorized BRP dealer is a great opportunity for your dealer to verify if your vehicle is included in any safety campaign. We also urge you to visit your authorized BRP dealer in a timely manner if you become aware of any safety related campaigns.

See an authorized BRP dealer for available accessories you may require.

Pre-Ride Inspection

WARNING

Perform a pre-ride inspection before each ride to detect any potential problem that could occur during operation. The pre-ride inspection can help you monitor component wear and deterioration before they become a problem. Correct any problem that you discover to reduce the risk of a breakdown or crash.

Before using this vehicle, the operator should always perform the following pre-ride inspection check list.

Pre-Ride Inspection Check List

What to Do Before Starting the Engine (Key OFF)

ITEMS TO BE INSPECTED	INSPECTION TO PERFORM	✓
Engine oil	Check engine oil level.	
Coolant	Check coolant level.	
Brake fluid	Check brake fluid level.	
Leaks	Check for any leaks under vehicle.	
Throttle lever	Activate throttle lever several times to ensure it operates freely. It must return to idle position when released.	
Parking brake	Apply parking brake and check if it operates properly.	
Tires	Check tire pressure and condition. Refer to <i>SPECIFICATIONS</i> and adjust according to load.	
Wheels	Check wheels for damage and for abnormal play, and make sure that lug nuts are tightened. Refer to <i>WHEELS AND TIRES</i> in <i>MAINTENANCE PROCEDURES</i> for torque specification.	
Radiator	Check cleanliness of the radiator.	
Drive shaft bellows	Check drive shaft bellows and protectors condition.	
Seat	Check if operator seat is in place and properly latched.	

ITEMS TO BE INSPECTED	INSPECTION TO PERFORM	✓
Cargo	If you transport a cargo, respect the load capacity. Refer to <i>LOADING THE CARGO RACKS</i> . Ensure cargo is properly secured to the rear cargo area.	
	If you are pulling a trailer or an other equipment: <ul style="list-style-type: none"> – Check hitch and trailer ball condition. – Respect the tongue capacity and towing capacity. as indicated on the label affixed to the hitch or refer to <i>SPECIFICATIONS</i>. – Ensure trailer is properly secured to hitch. 	
Glove box	Check if glove box is properly locked in position.	
Storage compartments	Check if rear storage compartments are properly latched.	
Chassis and suspension	Check underneath vehicle for any debris on chassis or suspension components and clean them properly.	

What to Do Before Starting the Engine (Key ON)

ITEMS TO BE INSPECTED	INSPECTION TO PERFORM	✓
Multifunction gauge	Check operation of indicator lamps in multifunction gauge (during first few seconds of key ON).	
	Check for messages on multifunction gauge.	
Lights	Check operation and cleanliness of headlights and taillight.	
	Check operation of high and low beam.	
	Check operation of brake light.	
Fuel level	Check the fuel level.	
Horn	Check operation of the horn (if equipped).	

What to Do After the Engine Is Started

ITEMS TO BE INSPECTED	INSPECTION TO PERFORM	✓
Steering	Check if steering operates freely by completely turning it from side to side.	
Shift lever	Check operation of shift lever (P, R, N, H and L).	
2WD/4WD selector	Check operation of 2WD/4WD selector.	

ITEMS TO BE INSPECTED	INSPECTION TO PERFORM	✓
Brakes	Drive forward slowly a few feet and apply brakes individually to test them. The brakes must fully apply. Lever and pedal must fully return when released.	
Engine stop switch	Check that the engine stop switch is working properly.	
Ignition switch (570)	Check if ignition switch is working properly by restarting and stopping the engine.	
RF D.E.S.S. post (650/850/1000R)	Check if D.E.S.S. post is working properly by pulling the D.E.S.S. key from D.E.S.S. post.	

Riding Gear

Actual weather conditions should help you decide how to dress. Dress for the coldest weather expected. Thermal underwear next to the skin also provides a good insulation. It is important that the operator always wears the appropriate protective clothing and apparel, including an approved helmet, eye protection, boots, gloves, a long sleeved shirt and pants. This type of clothing will provide you protection from some of the minor hazards you may encounter en route. The operator must never wear loose clothing such as a scarf that may get entangled in the vehicle or on tree branches and shrubs. Depending on conditions, anti-fogging goggles or sunglasses may be required. Different colored lenses available for goggles or sunglasses help you distinguish terrain variations. Sunglasses should only be worn during the daytime.

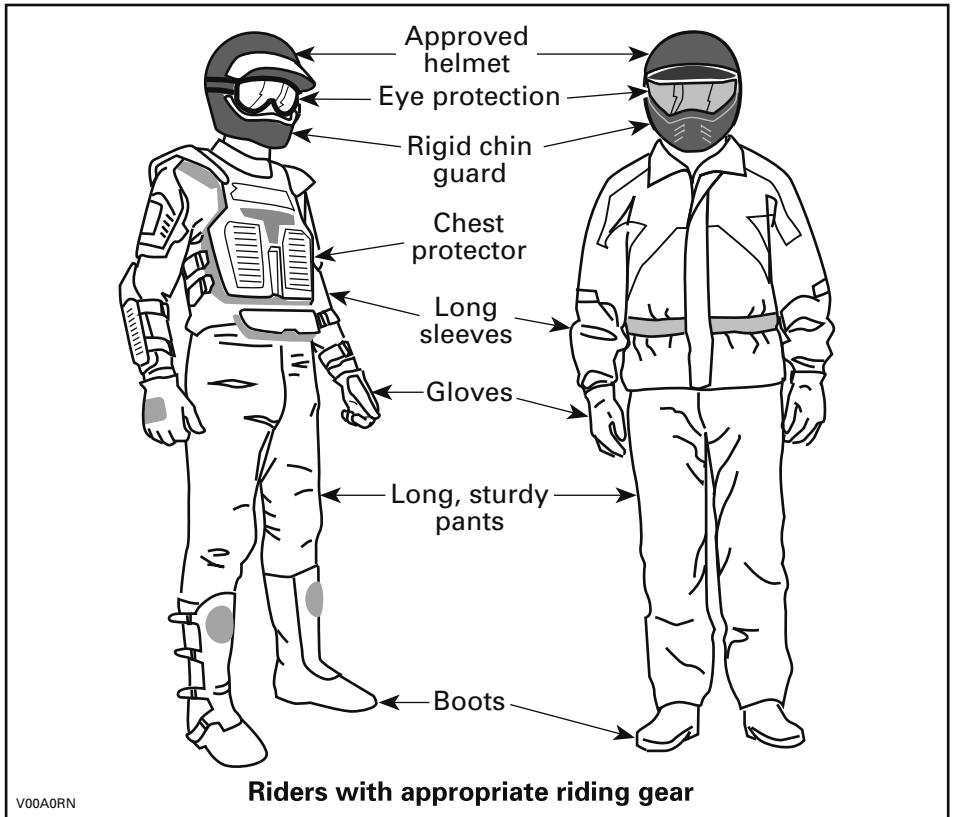

Carrying a Passenger is Prohibited

This vehicle is designed specifically to carry an operator only. Even with a long seat, this vehicle is not designed nor intended to carry passenger(s). NEVER install passenger seat or use the cargo area to carry passenger(s). Carrying passenger(s) may affect the stability and your control of the vehicle.

Carrying Loads

Any load carried on the vehicle will affect the handling, stability and braking distance of the vehicle. Do not exceed the total load allowed for this vehicle, including the weight of operator and passenger cargo, accessories and trailer tongue weight. Refer to *SPECIFICATIONS*. Always make sure the cargo is secured, properly distributed and cannot interfere with your controls or lights. Always be aware that the cargo may slide or fall off and cause an accident. Avoid loads that may protrude sideways and get snagged or caught in brush or other obstacles.

Safely reduce speed according to terrain conditions when carrying cargo or pulling a trailer. Allow greater distance for braking. Always secure cargo as low as possible on the rear rack to reduce the effect of a higher center of gravity.

MAXIMUM LOAD TABLE			
TOTAL LOAD ALLOWED	189 kg (417 lb)		Includes driver, all other loads, tongue weight and added accessories.
REAR CARGO AREA	Outlander Xmr 570	109 kg (240 lb)	Evenly distributed. Includes rear rack, rear storage box, rear storage compartment and tongue load.
	Outlander Xmr 650/850/1000R	90 kg (200 lb)	

The following is an example of suitable load distribution:

EXAMPLE OF LOAD DISTRIBUTION				
TOTAL VEHICLE LOAD	OPERATOR AND PASSENGER	CARGO LOAD	ACCESSORIES	TONGUE WEIGHT
189 kg (417 lb)	86 kg (190 lb)	70 kg (154 lb)	10 kg (22 lb)	23 kg (51 lb)

Loading the Cargo Rack

NOTICE When loading, do not exceed the weight limit. Refer to *CARRYING LOADS*.

Load cargo as low as possible – a higher load can raise the vehicle's center of gravity, which can reduce stability. Position cargo on the rack as evenly distributed as possible.

Secure the load on the cargo rack. Do not secure cargo to other parts of the vehicle. If it is not properly secured, a load may slide or fall off, possibly striking occupants or bystanders; or it may shift during riding, affecting the handling of the vehicle.

Objects that are high may affect visibility for the driver and may act as projectiles in case of an accident. Loads that protrude sideways can get snagged or caught in bush, branches or other obstacles. Avoid covering and obstructing the brake lights with the cargo. Ensure no cargo protrudes outside the cargo rack and that cargo will not interfere with your visibility or control of the vehicle.

NOTICE Do not exceed the cargo racks capacity. Refer to *SPECIFICATIONS*.

Never carry gasoline container(s) or any dangerous liquids on the cargo rack.

Hauling a Load (if Equipped with Hitch)

Never pull a load by attaching it to the bumper or any other parts or accessories; this can cause the vehicle to tip over. Use only the trailer hitch (if installed) to pull a load.

In an emergency situation, use the recovery hook to recover a stuck vehicle. Refer to *RECOVERY HOOKS* in *EQUIPMENT*.

When pulling loads with a chain or cable, ensure that there is no slack before starting and maintain tension while pulling.

When pulling loads with a chain or cable, be sure to brake progressively. The inertia of the load could lead to an impact.

When hauling a load, respect the maximum hauling capacity. See *PULLING A TRAILER* in this section.

WARNING

A slack in the chain or cable can cause it to break and snap back.

When pulling another vehicle, be sure that someone is controlling the pulled vehicle. They must brake and steer to prevent the vehicle from going out of control.

Reduce your speed when hauling a load and turn gradually. Avoid hills and rough terrain. Never attempt steep hills. Allow more distance for braking, especially on inclined surfaces. Be careful not to skid or slide.

Pulling a Trailer (if Equipped with Hitch)

NOTICE A BRP approved rear hitch must be properly installed on the vehicle for hauling trailers.

Riding this vehicle with a trailer substantially increases the risk of toppling, especially on inclined slopes. If a trailer is used behind the vehicle make sure that its hitch is compatible with the one on the vehicle. Make sure the trailer is horizontal with the vehicle. (In some instances a special extension may have to be installed on the vehicle hitch). Use security chains or cables to secure the trailer with the vehicle.

Reduce your speed when pulling a trailer and turn gradually. Avoid hills and rough terrain. Never attempt steep hills. Allow more distance for braking, especially on inclined surfaces. Be careful not to skid or slide.

Improperly loading a trailer may cause a loss of control.

Do not exceed the towing capacity or tongue capacity. Refer to *SPECIFICATIONS*.

Make sure there is at least some weight on the tongue.

Always make sure load is evenly distributed and safely secured on the trailer; an evenly balanced trailer is easier to control.

This vehicle may require additional stopping distance if hauling heavy loads, especially on inclined surfaces.

Always put the shift lever to L (low range) for hauling a trailer – in addition to providing more torque, operating in low range helps account for the increased load on the rear tires.

Keep vehicle speed at a slow pace, especially for turning. Be careful not to skid or slide.

When stopped or parked, block the vehicle and trailer wheels from possible movement.

Use caution when disconnecting a loaded trailer; it or its load may topple on you or others.

When hauling a trailer, respect the maximum hauling capacity indicated on the label on the hitch.

Working with your Vehicle

Your vehicle can help you perform a number of different LIGHT tasks ranging from snow removal to pulling wood or carrying cargo. A variety of accessories are available from your authorized Can-Am dealer. However, always respect the load and capacities of the vehicle. Overloading of the vehicle can overstress the components and cause failure. To prevent possible injury, it is equally important to follow the instructions and warnings that accompany the accessory. Avoid any physical exertion through lifting or pulling of heavy loads or man powering the vehicle. (Continue to read *RECREATIONAL RIDING* below).

Recreational Riding

This vehicle is designed specifically to perform in mud riding, the ground clearance being increased for such riding conditions. The ground clearance as well as the type of tires may substantially decrease the handling, traction and stability of the vehicle in some trail riding conditions. Reduce your speed in such conditions.

Respect the rights and limitations of others. Stay away from areas designated for other types of off road use. This includes snowmobile trails, equestrian trails, cross country ski trails, mountain bike trails, etc. Never assume there are no other users on the trail. Always stay to the complete right of the trail and do not zig zag to one side of the trail then the other. Be prepared to stop or pull off to the side if another trail user appears in front of you.

Join a local ATV club. It will provide you with a map and advice or inform you where you can ride. If a club does not exist in your area, help to start one. Group riding and club activities provide a pleasurable, social experience.

Always keep a safe distance from other riders. Your judgment of speed, terrain conditions, weather, mechanical condition of your vehicle and the “trust in judgment” you have in others around you will help you make a better choice of appropriate safe distance. This vehicle, like any other motorized vehicle, cannot stop “on a dime”.

Before you ride, tell someone where you are planning to travel and your expected time of return.

Depending on the length of your ride, carry additional tools, drinking water, food and emergency equipment. Find out where you can get additional gasoline and oil. Be prepared for the possible conditions you may encounter.

First aid kit	Adjustable wrench
Mobile phone	Knife
Friction tape	Flashlight
A rope	Colored lens goggles
Spare light bulbs	Trail map
Provided tool kit	Snack

Mud Riding

This vehicle is designed specifically for riding in mud. Unless if ridden in ATV trails, the low range should be used.

Although this vehicle is built for rough terrain and extreme conditions, an improper use may lead to premature wear or even failure of certain components. Avoid jerking steering and/or full steering stroke in very thick mud under high throttle demand.

Inspection and maintenance schedule need to be followed rigorously.

NOTE: Refer to *SUSPENSION ADJUSTMENT* in *TUNE YOUR RIDE* for suspension setting information.

Environment

One of the benefits of this vehicle is that it can take you off the beaten path away from most communities. However, you should always respect nature and the rights of others to enjoy it. Do not ride in environmentally sensitive areas. Do not drive over forest crops or shrubs, nor cut down trees or take down fencing, nor spin your wheels and destroy the terrain. “Tread Lightly”.

This vehicle can cause OHV wildfires if debris builds up near the exhaust or other engine hot spots and ignites then falls off into dry grass. Avoid riding in wet areas, through muskeg or tall grass, where debris can build up. Should you ride in those areas, inspect and remove all debris from your engine and hot spots.

Chasing wildlife is in many areas illegal. Wildlife can die of exhaustion after being chased by a motorized vehicle. If you encounter animals on the trail, stop and observe quietly and with caution. It will be one of the better memories of your life.

Observe the rule: “what you take in, carry out”. Do not litter. Do not start campfires unless you have permission to do so, and then only away from dry areas. The hazards you may create on the trail may cause injury to others or yourself, even at a later date.

Respect farm lands. Always obtain the permission of the landowner before riding on private land. Respect crops, farm animals and property lines. If you come to a closed a gate, close it again behind you.

Finally, do not pollute streams, lakes or rivers and do not modify the engine or exhaust system, or remove any of its components.

Design Limitation

Although the vehicle is exceptionally rugged for its class, it is still a light vehicle by definition and its operation must be restricted to its proper purpose.

The addition of weight to any part of the vehicle changes its gravitational stability and modifies its performance.

Off-Road Operation

The very nature of off-road operation is dangerous. Any terrain, which has not been specially prepared to carry vehicles, presents an inherent danger where terrain substance and exact steepness are unpredictable. The terrain itself presents a continual element of danger, which must be knowingly accepted by anyone venturing over it.

An operator who takes a vehicle off-road should always exercise the utmost care in selecting the safest path and keeping close watch on the terrain ahead of him. On no account should the vehicle be operated by anyone who is not completely familiar with the driving instructions applicable to the vehicle, nor should it be operated on steep or treacherous terrain.

General Operating and Safety Precautions

Care, caution, experience and driving skill are the best precautions against the hazards of vehicle operation.

Whenever there is the slightest doubt that the vehicle can safely negotiate an obstacle or a particular piece of terrain, always choose an alternate route.

In off-road operation, power and traction, not speed, are important. Never drive faster than visibility and your own ability to select a safe route permit.

Constantly watch the terrain ahead for sudden changes in slopes or obstacles, such as rocks or stumps, that may cause loss of stability, resulting in tip over or rollover.

Never operate the vehicle if the controls do not function normally.

When operating in reverse, check that the path behind the vehicle is free of people or obstacles. Proceed slowly and avoid sharp turns.

When stopped or parked, always set the shift lever to the PARK position and apply the parking brake. This is especially important when parking on a slope. On very steep inclines or if the vehicle is carrying cargo, the wheels should be blocked using rocks or bricks (or ideally, wheel chocks).

Reverse Operation

When operating in reverse, check that the path behind the vehicle is free of people or obstacles. Proceed slowly and avoid sharp turns.

We recommend sitting on your ATV when operating in reverse. Avoid standing up. Your weight could shift forward against throttle lever, causing an unexpected acceleration.

Uphill Driving

Due to configuration, this vehicle has excellent climbing ability, so much so that it is possible to tip over before traction is lost. For example, it is common to encounter terrain situations where the top of the hill has eroded to a point that the hill peak rises very sharply. The vehicle can readily negotiate such a condition, however, in doing so, when the front of the vehicle is driven to a point that the vehicle's balance moves rearward, a tip over can occur.

The same situation may apply if an embedded object causes the front of the vehicle to climb more than desired. If such a situation occurs take an alternate route. Be aware of side hilling dangers when doing so.

It is also wise to know the terrain condition on the other side of the hill or bank. All too often there exists a sharp drop-off that is impossible to negotiate or descend.

Downhill Driving

This vehicle can climb slopes that are steeper than it can safely descend. Therefore, it is essential to assure that a safe route exists to descend a slope before you climb it.

Decelerating while negotiating a slippery downhill slope could "toboggan" the vehicle. Maintain steady speed and/or accelerate slightly to regain control.

Side Hilling

Whenever possible, such operation should be avoided. If necessary, do so with extreme caution. Side hilling on steep inclines could result in rollover. In addition, slippery or loose surfaces could result in uncontrollable side sliding. Do not attempt to turn the vehicle downhill with the slide. Avoid all objects or depressions that will intensify the raising of one side of the vehicle higher than the other, thus causing rollover.

Drop-Offs

This vehicle will "bottom-out" and usually stop if either the front or rear wheels are driven over a drop-off. If the drop is sharp or deep, the vehicle will nose dive and tip over.

WARNING

Avoid negotiating drop-offs. Reverse and select an alternate route.

Riding on Snow Covered Surfaces

When performing the pre-ride inspection, pay special attention to locations on the vehicle where snow and/or ice accumulations may obstruct visibility of the taillight and reflectors, clog ventilation openings, block the radiator and fan, and interfere

with the movement of control levers, switches and brake pedal. Before starting with your ATV check the steering, throttle and brake lever and pedal controls for interference free operation.

Whenever an ATV is ridden on a snow covered drive path the tire grip is generally reduced causing the vehicle to react differently to control inputs from the operator. On low grip surfaces, the steering responses are not as crisp and precise, stopping distances are lengthened and acceleration becomes sluggish. Slow down and do not "gun" the throttle. This will only result in spinning of the tires and possibly in an over steering slide of the vehicle. Avoid hard braking. This will possibly result in a straight line slide of the vehicle. Again, the best advice is to safely reduce speed in anticipation of a maneuver so to give yourself time and distance to regain total vehicle control before it spins out of your control.

As you drive your ATV over a loose snow covered surface, snow dust will be picked up in the wake turbulence of the moving vehicle and transported to contact and accumulate or melt on some exposed components including rotating parts like brake discs. Water, snow or ice may affect the response time of the brake system of your ATV. Even when not required to reduce vehicle speed apply brakes frequently to prevent ice or snow accumulation and to dry brake pads and discs. While doing so in low risk driving situations you will test for grip level and keep yourself alerted to how the vehicle reacts to your control inputs. Always keep brake pedal, footrests, floor boards, brake and throttle levers free of snow and ice. Frequently wipe snow off seat, hand grips, headlights, taillights and reflectors.

The depth of the snow cover may hide rocks, tree stumps or other objects and if it is wet may totally impede the drivability as the vehicle becomes bogged down or completely loses traction in slushy snow. Look far ahead and always be watchful of any visible clues that might indicate the presence of such obstacles. In doubt steer clear. Avoid driving on any frozen body of water before checking that the ice will safely support the ATV, its riders and its load of cargo. Remember that a given thickness of ice may be sufficient to support a snowmobile but not an ATV of an identical weight because of the smaller load bearing surface of the four tire contact patches as compared to that of a snowmobile track and skis.

To maximize comfort and avoid frostbite, always wear clothing and ATV protective equipment appropriate for the weather conditions you will be exposed to during your ride.

At the end of each ride it is a good practice to clean the vehicle body and all moving components (brakes, steering components, drivelines, controls, radiator fan etc.) from any snow or ice accumulations. Wet snow will turn to ice during the shut down period and become more difficult to remove at the next pre-ride inspection.

Riding Techniques

Riding your vehicle too fast for the conditions may result in injury. Apply only enough throttle to proceed safely. Statistics show that mishaps and injury usually result from high speed turns. Always remember that this vehicle is heavy! Its pure weight alone may entrap you should it fall and pin you down.

This vehicle is not designed for jumping, nor can it fully absorb the high impact energy generated during manoeuvres such as jumping which, can be passed on to you, the operator. Performing wheelies can cause the vehicle to flip over onto you. Both practices have a high risk for you and should be avoided at all times.

To maintain proper control it is strongly advised that you keep your hands on the handlebar and within easy reach of all controls. The same holds true for your feet. To minimize the possibility of a leg or foot injury, keep your feet on the footrests at all times. Do not direct your toes outwards nor extend your feet out to assist in turning as they can be hit or be snagged on passing obstacles, or may come into contact with the wheels.

Always use proper riding techniques to avoid vehicle overturns on hills and rough terrain and in turns.

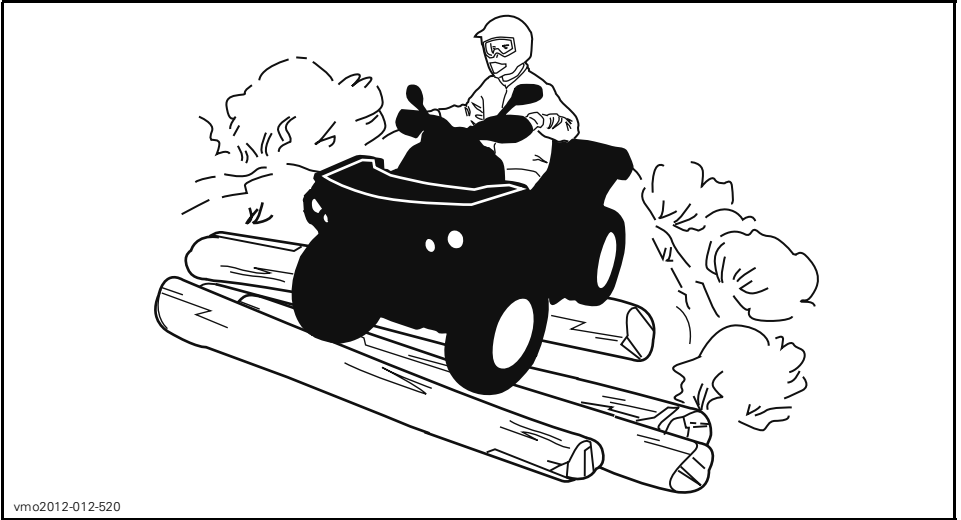

vmo2012-012-520

Even though there is an adequate suspension system on this vehicle there are “washboard” or rough terrain conditions that will make you feel uncomfortable and can even cause a back injury. “Posting” or riding in a crouched position will often be required. Slow down and allow your flexed legs to absorb part of the impact energy.

This vehicle is not designed for riding on roads or highways. (In most places it is an illegal practice). Riding your vehicle on roads or highways could cause a collision to occur with another vehicle.

The tires of this vehicle are not suited for paved road use. Also this vehicle is not equipped with a rear differential (rear wheels are always turning at the same speed). For these reasons, pavement may seriously affect the handling and control of the vehicle.

Riding on roads or soft shoulders may confuse other road users, especially if your lights are on.

If you have to cross a road, the lead driver should get off his vehicle, then observe and give directions to the other riders. The last person after crossing then assists the lead driver to cross. Do not travel on sidewalks. They are designated for pedestrian use.

Water can be a unique hazard. If it is too deep the vehicle may “float” and topple. Check the water depth and current before you attempt to cross any water. Water level should not go above the tires. Be wary of slippery surfaces such as rocks,

grass, logs, etc., both in the water and on its banks. A loss of traction may occur. Do not attempt to enter the water at high speed. The water will act as a brake and could throw you off the vehicle, on the ground.

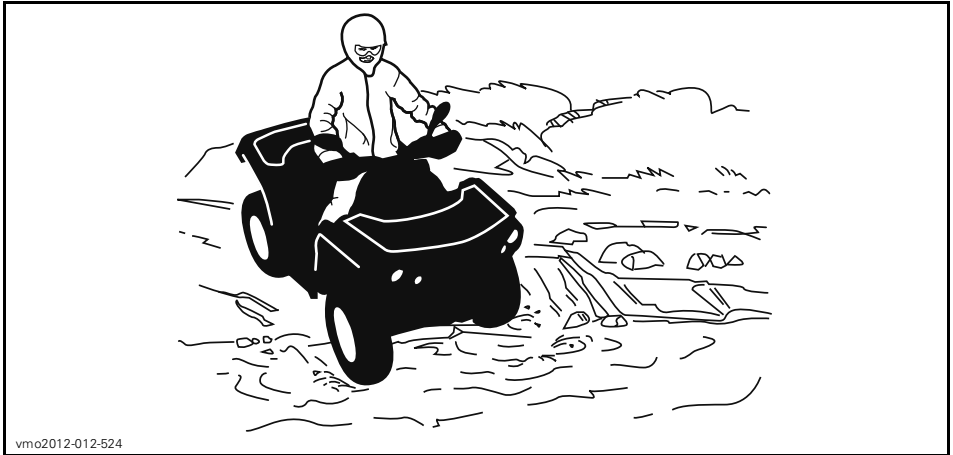

Water will affect the braking ability of your vehicle. Make sure you dry the brakes by applying them several times after the vehicle leaves the water.

Mud or marsh lands may be encountered near water. Be prepared for sudden “holes” or changes in depth. Similarly so, be watchful of hazards such as rocks, logs, etc., partially covered by vegetation.

If your route crosses frozen waterways, make sure the ice is thick enough and sound enough to support the total weight of yourself, the vehicle and its load. Be ever watchful of open water, it is a sure indication that the ice thickness will vary. If in doubt, do not attempt to cross.

Ice will also affect the control of the vehicle. Slow down and do not “gun” the throttle. This will only result in spinning of the tires and possible tip over of the vehicle. Avoid rapid braking. This again will possibly result in an uncontrolled slide and tip over of the vehicle. Slush should be avoided at all times since it could block the operation or controls of the vehicle.

Riding in snow may reduce the brakes stopping capability. Safely reduce speed and allow greater distance for braking. Snow projection may cause ice build up or snow accumulation on brake components and controls. Apply brakes frequently to prevent ice or snow accumulation. Refer to *GENERAL OPERATING AND SAFETY PRECAUTIONS* in this section for more detailed information regarding riding on snow covered surfaces.

Riding on sand, sand dunes or on snow is another unique experience, but there are some basic precautions that should be observed. Wet, deep or fine sand/snow may create a loss of traction and cause the vehicle to slide, drop off or become “bogged” down. If this occurs look for a firmer base. Again, the best advice is to slow down and be watchful of the conditions.

When riding in sand dunes it is advisable to equip the vehicle with an antenna type safety flag. This will help make your location more visible to others over the next sand dune. Proceed carefully should you see another safety flag ahead. Since the antenna type safety flag can snag and rebound on your body if caught, do not use it in areas where there are low hanging branches or obstacles.

Riding on loose stones or gravel is very similar to riding on ice. They will affect the steering of vehicle, possibly causing it to slide and tip over especially at high speeds. In addition, braking distance may be affected. Remember that "gunning" the throttle or sliding may cause loose stones to be ejected rearwards into the path of another rider. Never do it deliberately.

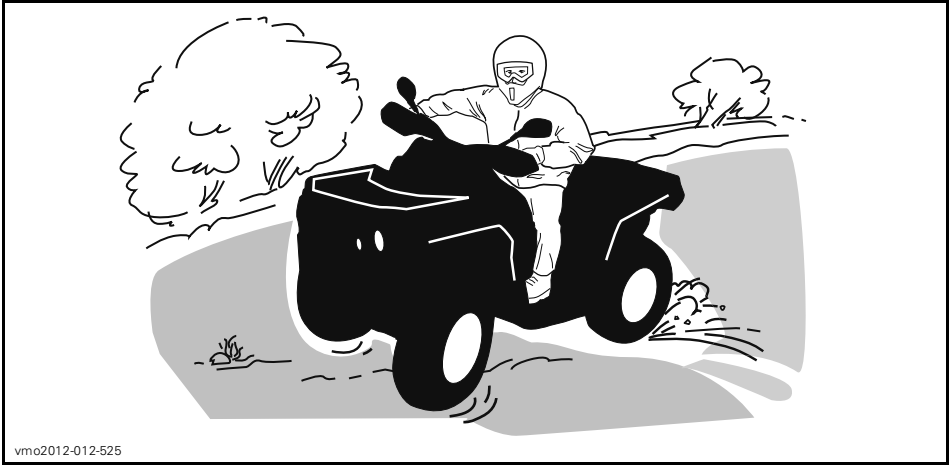

vmo2012-012-525

If you do get into a slide or skid, it may help to turn the handlebar in the direction of the skid until you regain control. Never jam the brakes and lock the wheels.

Respect and follow all posted trail signs. They are there to help you and others.

Obstacles in the "trail" should be traversed with caution. This includes loose rocks, fallen trees, slippery surfaces, fences, posts, and embankments and depressions. You should avoid them whenever possible. Remember that some obstacles are too large or dangerous to cross and should be avoided. Small rocks or fallen trees may be safely crossed, approach at a 90° angle. Stand on the footrests while keeping your knees flexed. Adjust speed without losing momentum and do not "gun" the throttle. Hold handlebar firmly. Place your body weight rearwards and proceed. Do not try to lift the vehicle front wheels off the ground. Be aware that the object may be slippery or may move while crossing.

When driving on hills or slopes two things are highly important. Be prepared for slippery surfaces or terrain variations and obstacles and use proper body positioning.

When stopped or parked always apply the parking device. This is especially important when parking on a slope. On very steep inclines or if the ATV is carrying cargo, the wheels should be blocked using rocks or bricks (or ideally, wheel chocks).

Uphill

Before trying to climb a hill, keep these things in mind. Hill Climbing should only be attempted by experienced operators. Start on shallow slopes. Always drive straight uphill and keep your body weight forward towards the top of the hill. Keep your feet on the footrests, shift your ATV into a lower gear and accelerate before you start to climb. Try to keep a steady speed and go easy on the throttle to avoid acceleration. Abrupt slope or terrain variation or rolling one wheel over an obstacle could have a big impact on the stability as it will lift the front of the vehicle increasing the risk of tipping over. Some hills are too steep to safely stop or recover from after an unsuccessful climbing attempt. Try to avoid steep inclines. If you're not careful, you could tip over when going up hills. If the hill is too steep and you cannot proceed or the vehicle begins to roll backwards, apply the parking brake, being careful not to slide. Dismount on the left side to access the brake lever then use the "K" turn (while walking back, next to the vehicle on the up hill side and with a hand on the brake lever, slowly back the rear of the vehicle toward the top of the hill then drive downhill). Always walk or dismount on the upside of the slope while keeping clear of the vehicle and its rotating wheels. Do not try to hold on to the vehicle if it begins to topple. Stay clear. Do not ride over the crest of the hill at high speed. Obstacles, including sharp drop-offs, may exist.



Downhill

Keep your body weight rearwards. Stay seated. Apply the brake gradually to prevent skidding. Do not "coast" down the slope using solely engine compression or in neutral gear.

Decelerating while negotiating a slippery downhill slope could "toboggan" the vehicle. Maintain steady speed and/or accelerate slightly to regain control. Try to avoid steep inclines. If you're not careful, you could tip over when going down hills.

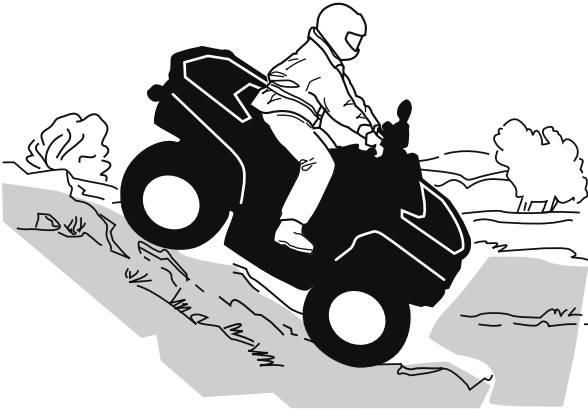

vmo2012-012-523

Side Hilling

This is one of the **most risky** types of riding since it may drastically change the balance of the vehicle. It should be avoided wherever possible. However, if it is necessary to do so, it is important that you **ALWAYS** keep your body weight on the up-side of the slope and be prepared to dismount on that side should the vehicle begin to topple.

⚠ WARNING

Do not try to stop or save the vehicle from damage.

⚠ WARNING

Be careful when loading and transporting liquid reservoirs. They can affect vehicle stability when side hilling by pulling downhill and increasing the risk of a roll over.















vmo2012-012-527

IMPORTANT ON-PRODUCT LABELS (CANADA/UNITED STATES)

This vehicle comes with hang tags and labels containing important safety information.

Any person who rides this vehicle should read and understand this information before riding.

Hang Tags

<p>S SPORT MODEL</p> <p>THIS CATEGORY S (SPORT) ATV IS FOR RECREATIONAL USE BY EXPERIENCED OPERATORS ONLY.</p> <p>OPERATOR ONLY-NO PASSENGERS</p> <p>NO OPERATOR UNDER AGE 16</p> <hr/> <p>THIS CATEGORY S (SPORT) ATV IS A HIGH PERFORMANCE ATV FOR OFF ROAD USE ONLY. IT IS FOR SPORT TYPE RECREATIONAL AND COMPETITIVE USE BY OPERATORS WITH ADVANCED SKILLS AND SUBSTANTIAL EXPERIENCE.</p> <hr/> <p>TRAINING COURSES TO TEACH ATV RIDING SKILLS ARE AVAILABLE. FOR INFORMATION CONTACT YOUR DEALER.</p> <hr/> <p>CHECK WITH YOUR DEALER TO FIND OUT ABOUT STATE OR LOCAL LAWS REGARDING ATV OPERATION.</p> <p>THIS HANGTAG IS NOT TO BE REMOVED BEFORE SALE.</p> <p>704903318</p>	<p>⚠ WARNING</p> <p>Improper ATV use can result in SEVERE INJURY or DEATH.</p> <table border="0"><tr><td></td><td></td><td></td><td></td></tr><tr><td>ALWAYS USE AN APPROVED HELMET AND PROTECTIVE GEAR.</td><td>NEVER USE ON PUBLIC ROADS.</td><td>NEVER CARRY PASSENGERS.</td><td>NEVER USE WITH DRUGS OR ALCOHOL.</td></tr></table> <p>NEVER operate:</p> <ul style="list-style-type: none">• without proper training or instructions.• at speeds too fast for your skills or the conditions.• on public roads - a collision can occur with another vehicle.• with a passenger - passengers affect balance and steering and increase risk of losing control. <p>ALWAYS:</p> <ul style="list-style-type: none">• use proper riding techniques to avoid vehicle overturns on hills and rough terrain and in turns.• avoid paved surfaces - pavement may seriously affect handling and control. <p>LOCATE AND READ OPERATOR'S GUIDE. FOLLOW ALL INSTRUCTIONS & WARNINGS.</p>					ALWAYS USE AN APPROVED HELMET AND PROTECTIVE GEAR.	NEVER USE ON PUBLIC ROADS.	NEVER CARRY PASSENGERS.	NEVER USE WITH DRUGS OR ALCOHOL.
									
ALWAYS USE AN APPROVED HELMET AND PROTECTIVE GEAR.	NEVER USE ON PUBLIC ROADS.	NEVER CARRY PASSENGERS.	NEVER USE WITH DRUGS OR ALCOHOL.						

TYPICAL

While reading this Operator's Guide, remember that:

⚠ WARNING

Indicates a potential hazard that, if not avoided, could result in serious injury or death.

⚠ WARNING. Operating, servicing and maintaining an off-road vehicle can expose you to chemicals including engine exhaust, carbon monoxide, phthalates, and lead, which are known to the State of California to cause cancer and birth defects or other reproductive harm.

To minimize exposure, avoid breathing exhaust, do not idle the engine except as necessary, service your vehicle in a well-ventilated area and wear gloves or wash your hands frequently when servicing your vehicle.

For more information go to www.P65Warnings.ca.gov/products/passenger-vehicle



704906872

EN-704906872-DEC

VEHICLE ENGINE DESCRIPTION:
XXXXX

EPA CERTIFIED

NER (NORMALIZED EMISSION RATE) =
ON A 0 TO 10 SCALE, 0 BEING THE CLEANEST

***NOT TO BE REMOVED PRIOR TO SALE**



704901107

vmo2006-005-009_en

TYPICAL

Vehicle Safety Labels

Read and understand all the safety labels on your vehicle. These labels are affixed to your vehicle for the safety of the operator or bystanders.

The safety labels on your vehicle should be considered permanent parts of the vehicle. If missing or damaged, they can be replaced free of charge. See an authorized Can-Am dealer.

NOTE: In the event of any discrepancy between this guide and the vehicle, the safety labels on the vehicle have precedence over the labels in this guide.

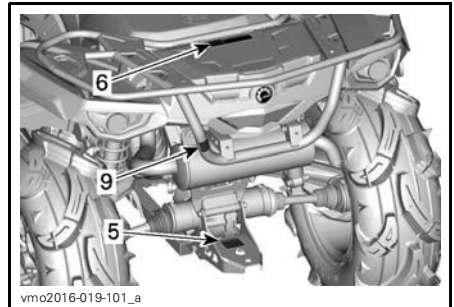
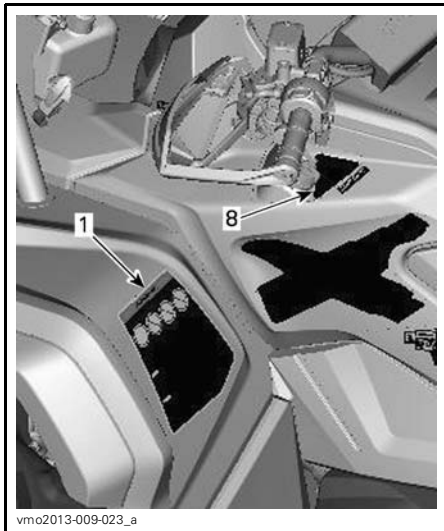
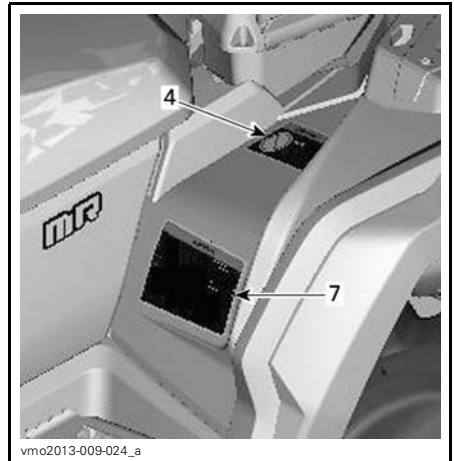
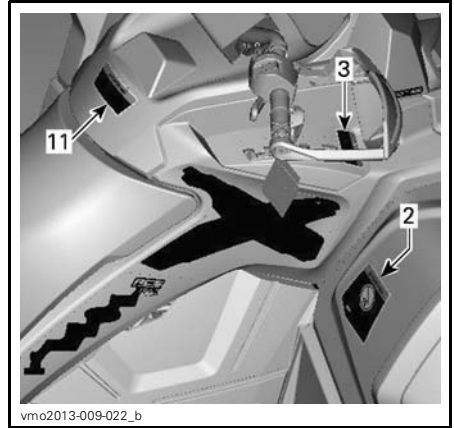

TYPICAL - 570 MODELS

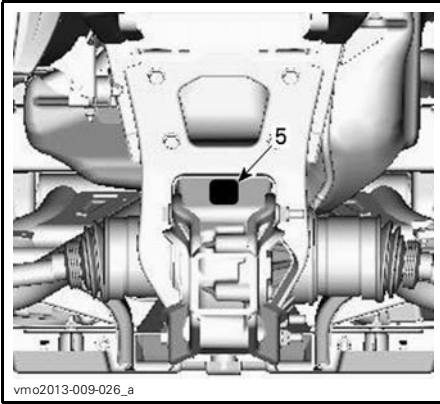

TYPICAL - 650, 850 AND 1000R MODELS



1000R MODELS

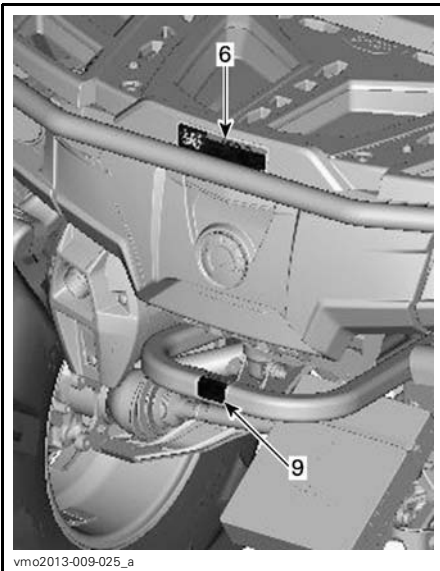

TYPICAL - 650, 850 AND 1000R MODELS

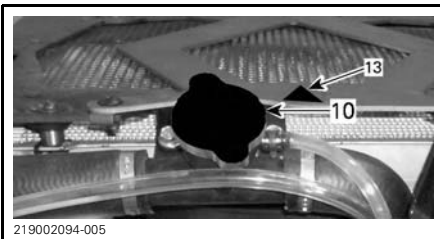

⚠️ WARNING

Improper ATV use can result in SEVERE INJURY or DEATH



ALWAYS USE AN APPROVED HELMET AND PROTECTIVE GEAR



NEVER USE ON PUBLIC ROADS



NEVER CARRY PASSENGERS



NEVER USE WITH DRUGS OR ALCOHOL

NEVER operate:

- without the proper ATV training or instructions.
- at speeds too fast for your skills or conditions.
- on public roads - a collision can occur with another vehicle.
- with a passenger - passengers affect balance and steering and increase risk of losing control.

ALWAYS

- use proper riding techniques to avoid vehicle overturns on hills and terrain and in turns.
- avoid paved surfaces - pavement may seriously affect handling and control.

Read and understand all safety labels, locate and read operator's guide and watch the safety video using the QR code link or visit Can-am web site before operation.



**LOCATE AND READ OPERATOR'S GUIDE
FOLLOW ALL INSTRUCTIONS & WARNINGS.**



8010

Patent : www.brp.com/en/about-brp/patents.html

EN-704908010-DEC

LABEL 1

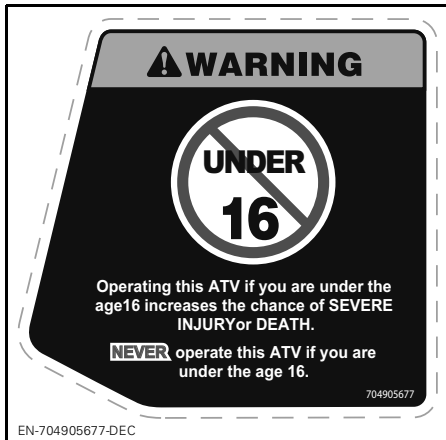

LABEL 2

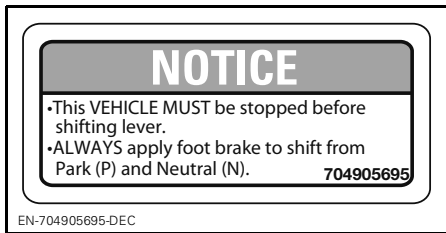

LABEL 3



LABEL 4

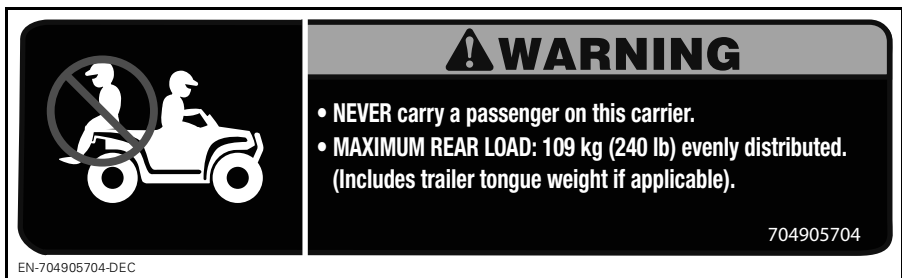

LABEL 6 - OUTLANDER X mr (570): REAR FENDER (REFER TO SPECIFICATIONS FOR VALUES)



LABEL 5



⚠ WARNING

- **NEVER** carry a passenger on this carrier.
- **MAXIMUM REAR LOAD: 90 kg (200 lb)** evenly distributed.
(Includes trailer tongue weight if applicable).



704906857

EN-704906857-DEC

LABEL 6 - OUTLANDER X mr (650/850/1000R): REAR FENDER (REFER TO SPECIFICATIONS FOR VALUES)

⚠ WARNING

Improper tire pressure or overloading can cause loss of control, resulting in **SEVERE INJURY** or **DEATH**.

ALWAYS maintain proper tire pressure as shown. Inflate at max pressure when loaded with cargo.

NEVER set tire pressure below minimum. It could cause the tire to dislodge from the rim.

NEVER exceed the vehicle load capacity of 189 kg (417 lb) including weight of operator, cargo, accessories and trailer tongue weight.

ATV LOADING and TRAILER TOWING

- Cargo loading or trailer towing can affect stability and handling. Load must be properly distributed on racks.
- When loaded with cargo or towing a trailer:
 - reduce speed.
 - allow more distance to stop.

LOAD	COLD TIRE PRESSURE
UP TO 189 kg (417 lb)	FRONT
	MAX: 48.3 kPa (7.0 psi)
	MIN: 41.4 kPa (6.0 psi)
	REAR
	MAX: 48.3 kPa (7.0 psi)
	MIN: 41.4 kPa (6.0 psi)



704906848

EN-704906848-DEC

LABEL 7: (REFER TO SPECIFICATIONS FOR VALUES)

⚠ WARNING

This vehicle is an all terrain vehicle and is not intended for use on public roads. 704905680

⚠ AVERTISSEMENT

Ce véhicule est un véhicule tout terrain qui n'est pas destiné à être utilisé sur les voies publiques.

EN_704905680_DEC

LABEL 8



LABEL 9



LABEL 10 - LOCATED ON RADIATOR CAP

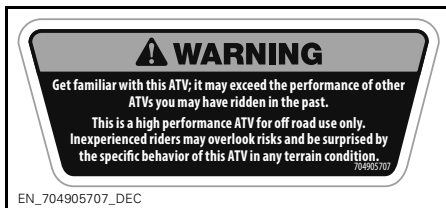

LABEL 11

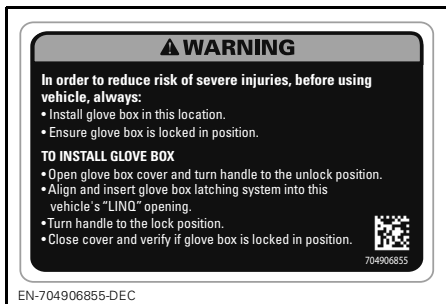

1000R MODELS

LABEL 12 - LOCATED UNDER GLOVE BOX



LABEL 13 - LOCATED ON COOLANT RESERVOIR

Compliance Labels

These labels indicate vehicle's compliance.

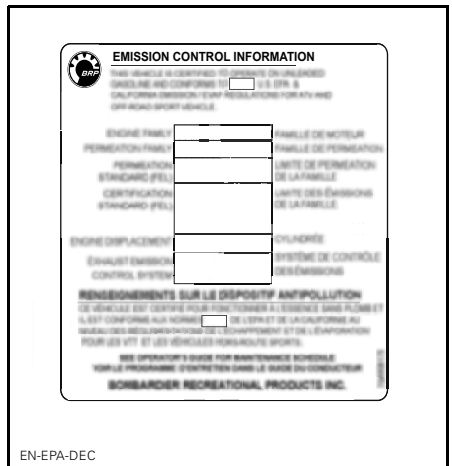

TYPICAL - UNDER SEAT



REAR FENDER

Technical Information Label

AIR FILTER MAINTENANCE

MAINTENANCE MUST BE PERFORMED AS SPECIFIED IN THE OPERATOR'S GUIDE. AIR FILTER MAINTENANCE SHOULD INCREASE IN FREQUENCY IN MORE SEVERE (DUSTY) CONDITIONS.

ENTRETIEN DU FILTRE À AIR

L'ENTRETIEN DOIT ÊTRE EFFECTUÉ TEL QUE SPÉCIFIÉ DANS LE GUIDE DU CONDUCTEUR. ENTRETIENIR LE FILTRE À AIR PLUS SOUVENT DANS DES CONDITIONS PLUS EXTRÊMES (MILIEUX POUSSIÉREUX). 707800373

707800373

UNDER SEAT

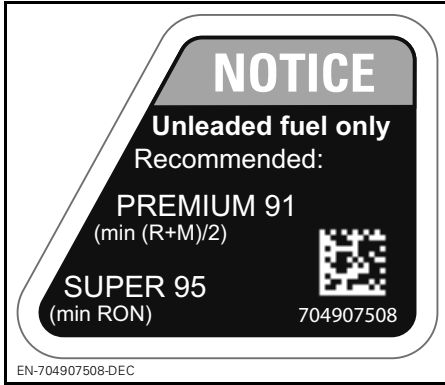

EN-704907508-DEC

NEAR GAS CAP OF 1000R ENGINES

IMPORTANT ON-PRODUCT LABELS (ALL COUNTRIES EXCEPT CANADA/UNITED STATES)

This vehicle comes with hang tags and labels containing important safety information.

Any person who rides this vehicle should read and understand this information before riding.

Vehicle Safety Labels

Read and understand all the safety labels on your vehicle. These labels are affixed to your vehicle for the safety of the operator or bystanders.

The safety labels on your vehicle should be considered permanent parts of the vehicle. If missing or damaged, they can be replaced free of charge. See an authorized Can-Am dealer.

NOTE: In the event of any discrepancy between this guide and the vehicle, the safety labels on the vehicle have precedence over the labels in this guide.

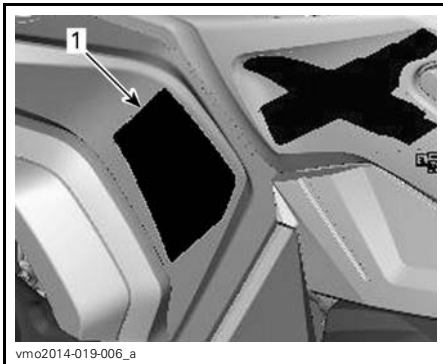
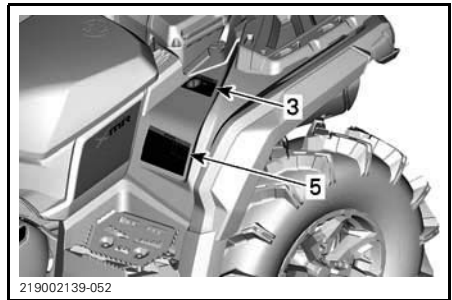
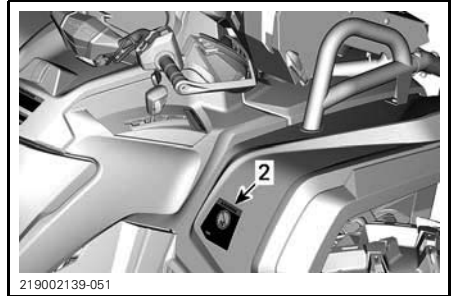

LOCATED LEFT OF HANDLEBAR

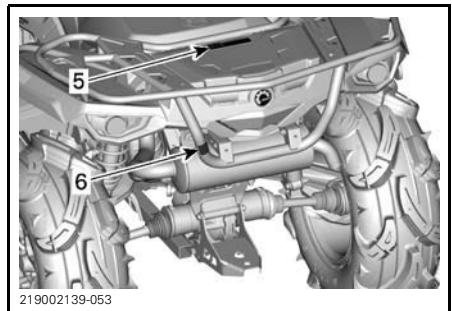

TYPICAL - 570 MODELS

While reading this Operator's Guide, remember that:

WARNING

Indicates a potential hazard that, if not avoided, could result in serious injury or death.

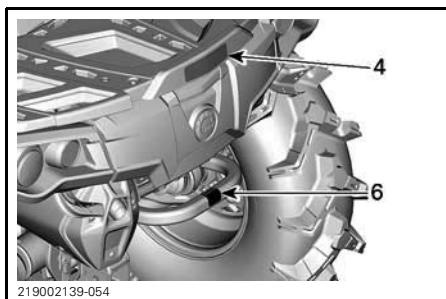

219002139-054

TYPICAL - 650 AND 1000R MODELS

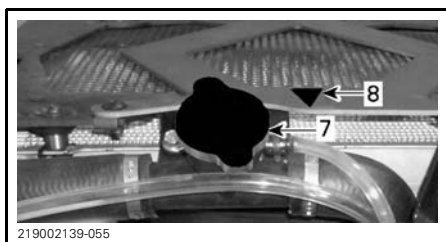

219002139-055



219002139-056

TYPICAL - 1000R MODEL

Label 1

⚠ WARNING

- Always use an approved helmet and protective gear.
- Always wear ear protection.
- Locate and read operator's guide. Improper ATV use can result in SEVERE INJURY or DEATH. Follow all instructions and warnings.
- Never use on public roads.
- Never carry a passenger.
- Never use with drugs or alcohol.

<https://can-am.brp.com/off-road/safety>

Patent : www.brp.com/en/about-brp/patents.html 8012

EN-704908012-DEC

LABEL 1

Label 2

⚠ WARNING

Operating this ATV if you are under the age of 16 increases the chance of SEVERE INJURY or DEATH to the operator. NEVER operate this ATV if you are under age 16.

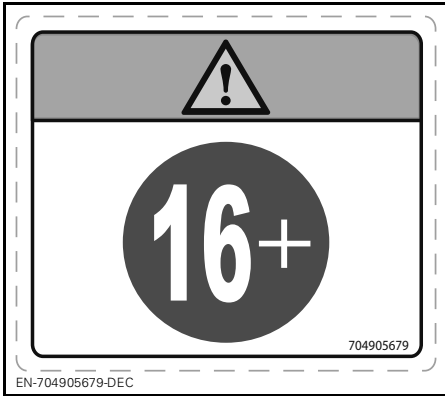

LABEL 2

Label 3

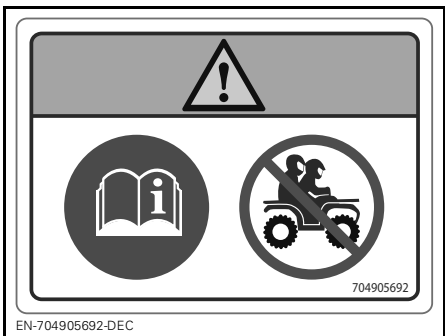
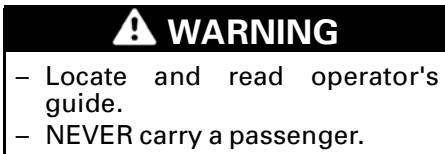

LABEL 3

Label 5

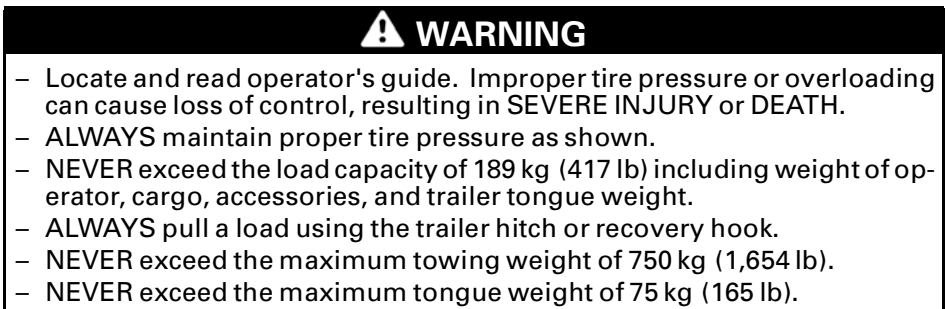

Label 4

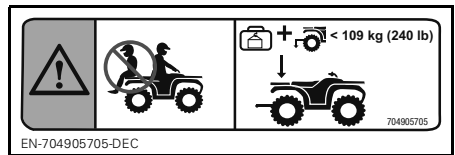
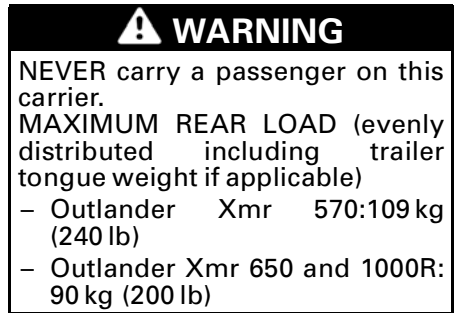

LABEL 4 - OUTLANDER Xmr (570): REAR FENDER (REFER TO SPECIFICATIONS FOR VALUES)

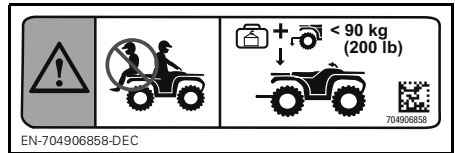

LABEL 4 - OUTLANDER Xmr (650/1000R): REAR FENDER (REFER TO SPECIFICATIONS FOR VALUES)

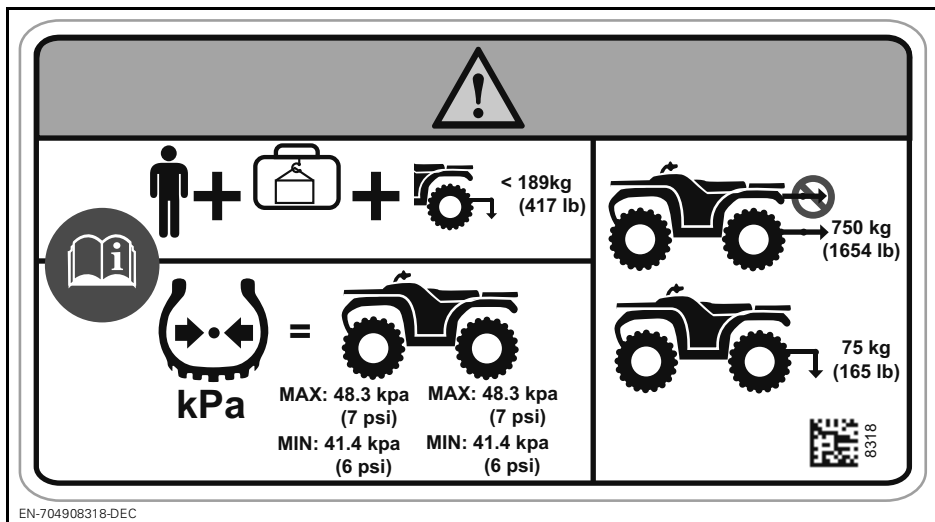

LABEL 5

Label 6

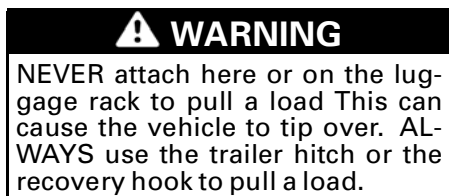

Label 7



LABEL 7 - LOCATED ON RADIATOR CAP



LABEL 6

Label 8

 WARNING
Do not open when hot.



LABEL 8

Label 9

⚠ WARNING

1. Open glove box cover and turn latch to the unlock position.
 2. Align and insert glove box latching system into the vehicle's "LINQ" opening.
 3. Turn latch to the lock position.
 4. Close cover and verify if glove box is locked in position.
- Locate and read operator's guide for more information.

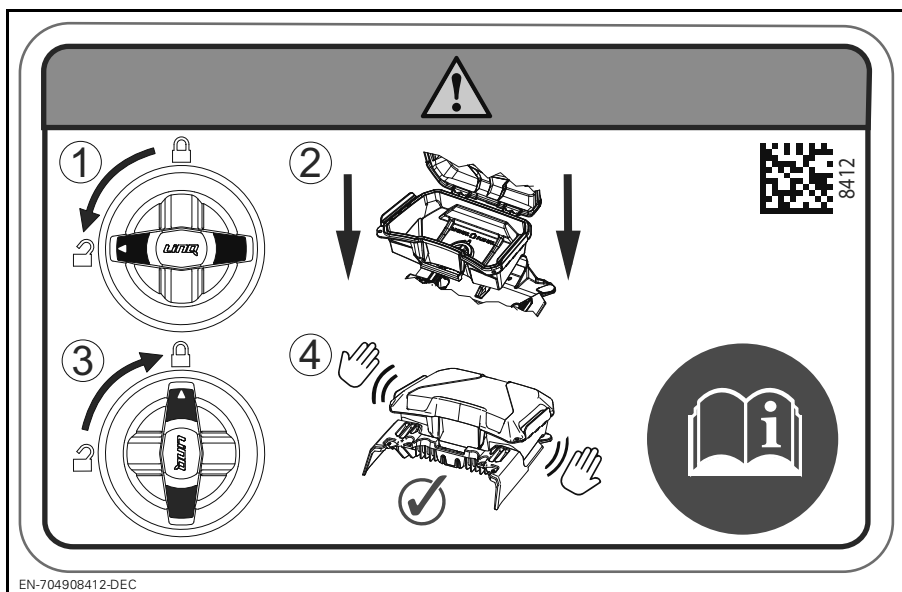

EN-704908412-DEC

LABEL 9 - UNDER GLOVE BOX

Compliance Labels

These labels indicate vehicle's compliance.

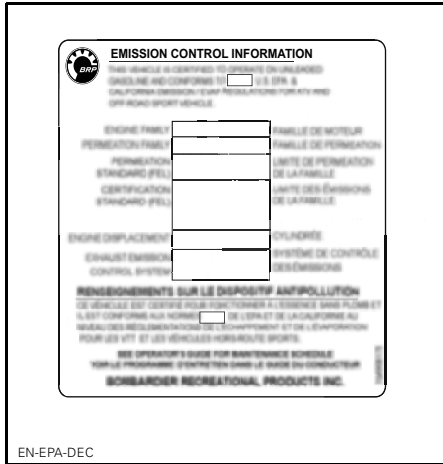

TYPICAL: LOCATION: UNDER SEAT APPLICABLE WHEN EQUIVALENT TO A MODEL CERTIFIED TO US EPA STANDARDS.



NEAR GAS CAP

Technical Information Label

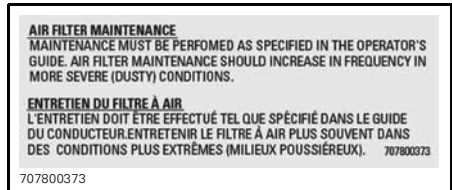

LOCATION: UNDER SEAT, ON THE UPPER FRAME MEMBER

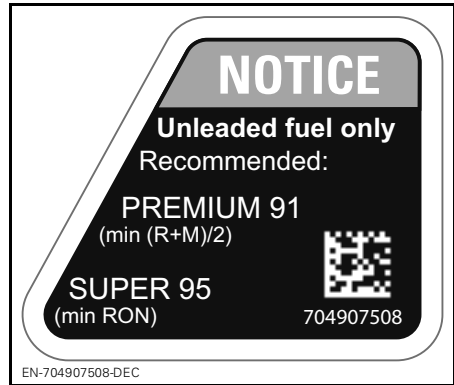

NEAR GAS CAP OF 1000R ENGINES

NOTICE This vehicle must be stopped before shifting lever. ALWAYS apply foot brake to shift from Park (P) and Neutral (N).

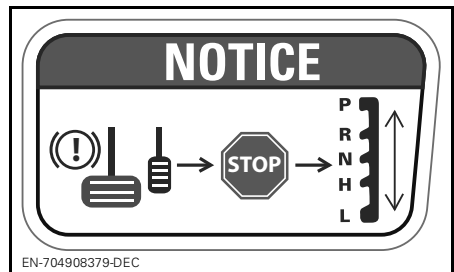

IN FRONT OF THE SHIFT LEVER

REPORTING SAFETY DEFECTS

In Canada, if you believe that your vehicle has a defect which could cause a crash or could cause injury or death, you should immediately inform Transport Canada in addition to notifying Bombardier Recreational Products Inc.

If Transport Canada receives similar complaints, it may open an investigation, and if it finds that a safety defect exists in a group of vehicles, it may order a recall and remedy campaign. However, Transport Canada cannot become involved in any individual problems between you, your dealer or Bombardier Recreational Products Inc.

TO CONTACT TRANSPORT CANADA:



819-994-3328 (Gatineau-Ottawa area or internationally)
Toll free : 1 800-333-0510 (in Canada)



Transport Canada - ASFAD
330 Sparks Street
Ottawa, ON
K1A 0N5



<https://www.tc.gc.ca/recalls>

While reading this Operator's Guide, remember that:

WARNING

Indicates a potential hazard that, if not avoided, could result in serious injury or death.

***This page is
intentionally blank***

VEHICLE INFORMATION

PRIMARY CONTROLS

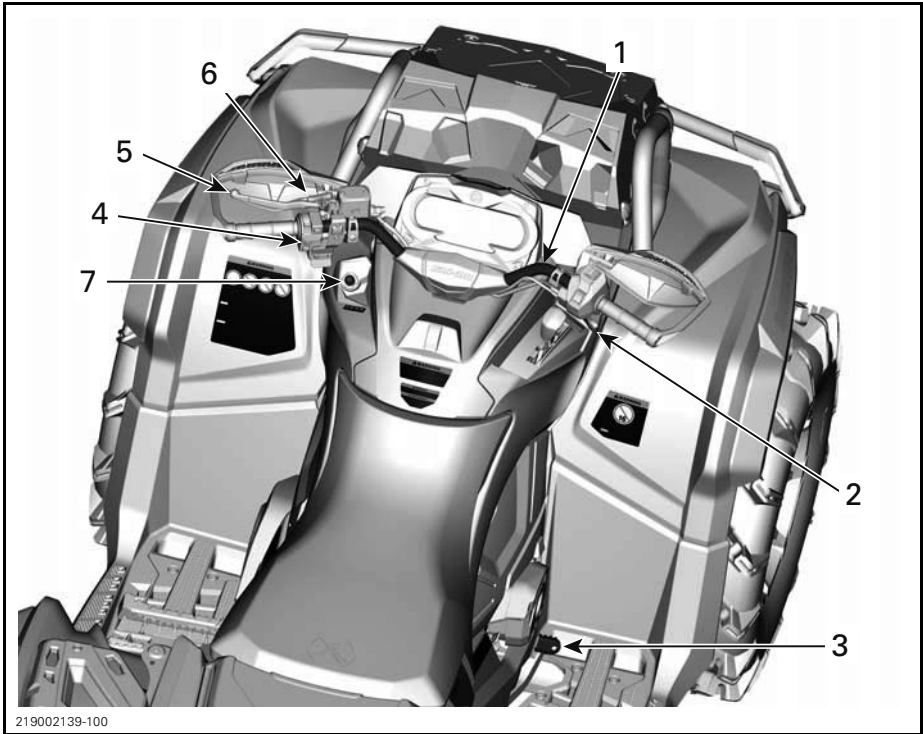

219002139-100

TYPICAL - OUTLANDER X MR 1000R SHOWN

1. Handlebar
2. Throttle lever
3. Brake pedal
4. Engine stop switch
5. Brake lever
6. Parking brake lever
7. Ignition switch / Engine cut-off switch

1) Handlebar

The handlebar controls the steering of the vehicle. As the handlebar is rotated to right or left, the front wheels are turned in this direction to steer the vehicle.

WARNING

Fast reverse while turning, could result in loss of stability and control.

While reading this Operator's Guide, remember that:

WARNING

Indicates a potential hazard that, if not avoided, could result in serious injury or death.

2) Throttle Lever

The throttle lever is located at the bottom of the throttle lever control housing.

When pushed forward, it increases the engine speed and allows engagement of the transmission on the selected range.

When released, the engine speed should automatically return to idle and the vehicle will gradually slow down.

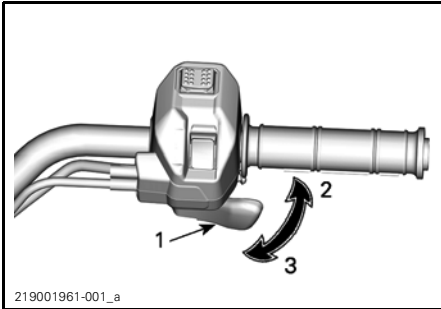

TYPICAL

1. Throttle lever
2. To accelerate
3. To decelerate

3) Brake Pedal

The brake pedal is located on the RH side footrest.

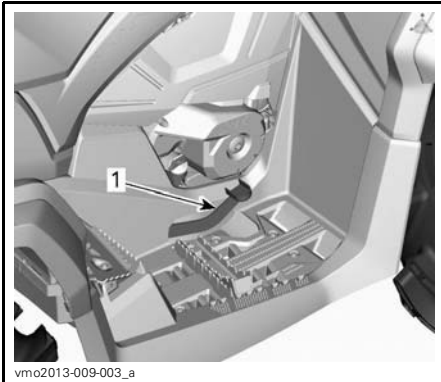

1. Brake pedal

All Models Except 1000R

When the brake pedal is pressed down, the rear brake is applied.

1000R Models

When the brake pedal is pressed down, the front and rear brakes are applied.

All Models

When released, the brake pedal should return to its original position.

Braking effect is proportional to the force applied on the pedal.

NOTE: The brake will have also an effect on front wheels through the drive train when 4WD is engaged.

Should the brake lever system fail, the rear brake can be used by depressing the brake pedal.

4) Engine Stop Switch

The engine stop switch is located at the middle of the multifunction switch.

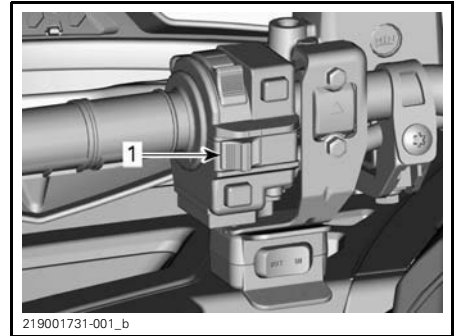

TYPICAL

1. Engine stop switch

This switch can be used to stop the engine and as an emergency control.

To stop engine, fully release throttle lever then set the engine stop switch to the STOP position.

NOTE: While the engine can be stopped by turning the ignition key to OFF position (570) or by removing the D.E.S.S. key (650/850/1000R), we recommend the engine be stopped by setting the engine stop switch to the STOP position.

5) Brake Lever

The brake lever is located on the LH side of the handlebar.

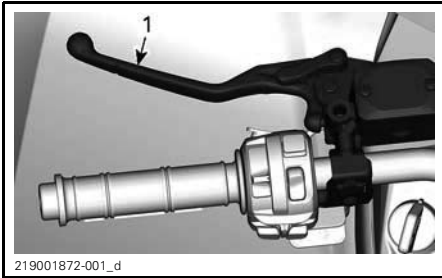

1. Brake lever

The brake lever function is to slow down or stop the vehicle.

When the brake lever is compressed, the front and rear brakes are applied.

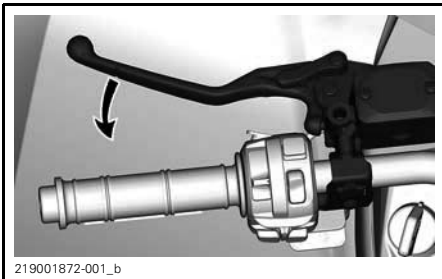

Braking effect is proportional to the force applied on the lever.

6) Parking Brake Lever

The parking brake lever is located on the LH side of the handlebar.

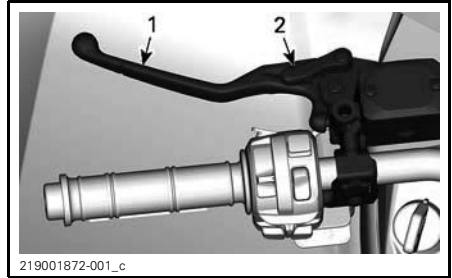

1. Brake lever
2. Parking brake lever

The parking brake function is to maintain brakes to all wheels to prevent the vehicle from moving when parked.

⚠ WARNING

Always use the parking brake **and** engage the PARK position on the shift lever when the vehicle is not in operation.

To engage the parking brake proceed as shown:

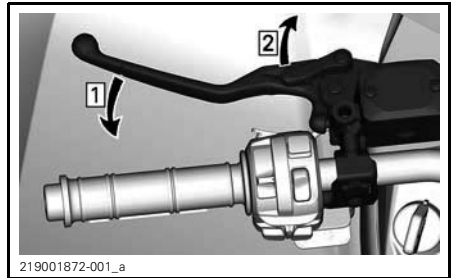

Step 1: Apply brakes
Step 2: Lock brakes

NOTE: The parking brake lever can be set to several positions.

NOTICE When the parking brake is applied, make sure the vehicle stays securely in place.

To release the parking brake, simply squeeze the brake lever. It should return to the rest position.

⚠ WARNING

Make sure the parking brake is released before operating the vehicle. If parking brake is left ON while riding, it may cause damage to the brake system and cause loss of braking capacity and/or fire.

7) Ignition Switch and RF D.E.S.S. Keys

Ignition Switch

570 Engines Models

The ignition switch is located on the LH side of the central panel below the handlebar.

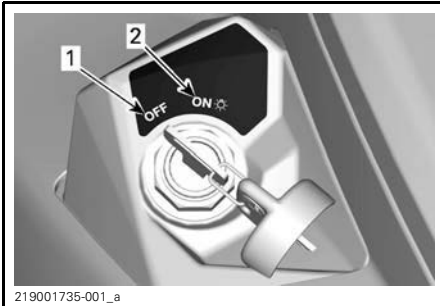

IGNITION SWITCH POSITIONS

1. OFF
2. ON "with light"

OFF

The key can be inserted or removed in this position only.

In OFF position, the electrical system of the vehicle is disabled.

The engine is shut down by turning the ignition switch to OFF position.

NOTE: While the engine can be stopped by turning the ignition key to OFF position, we recommend the engine be stopped by setting the engine stop switch to the STOP position.

NOTE: When turning the key to OFF position, the vehicle electrical system will take a few seconds to shut down.

ON with Lights

When the key is turned in this position, the electrical system of the vehicle is activated.

The gauge is turned on.

The vehicle lights are turned on.

The engine can be started.

D.E.S.S. Key

All except 570 Engines Models

The ignition keys contain an electronic circuit that gives it a unique electronic serial number.

The D.E.S.S. system reads the key code and allows engine starting for keys it recognizes.

This vehicle can be operated using 2 different types of key programming:

- Normal
- Performance

Refer to your dealer for complete information.

The vehicle is delivered with 1 performance key.

NOTE: Additional keys are available from your dealer as an accessory.

⚠ WARNING

Rollovers, tipovers, collisions and loss of control resulting in serious injury or death are possible with the performance or normal key. Using the normal key is not a substitute for the operator being prepared, qualified, and operating with care.

Performance Key

The performance key allows the user to access the full torque of the engine as well as the top speed of the vehicle.

This may be useful for riders who prefer crisper throttle response, and for environments where higher speeds and greater acceleration are appro-

appropriate. For example, in wide-open straight trails, operators may prefer the performance key.

Normal Key

The normal key limits the vehicle rate of acceleration and/or the vehicle speed to 70 km/h (43 MPH).

⚠ WARNING

On steep downhills, the engine speed limiter may not prevent the vehicle from accelerating beyond this speed.

This key may be useful for riders who prefer more gradual acceleration, or for riding in environments where full speed and high acceleration are not desirable. For example, in narrow, winding trails, operators may prefer a normal key.

D.E.S.S. Flexibility

The D.E.S.S. of your vehicle can be programmed by your authorized Can-Am dealer to accept up to 8 different keys.

If you have more than one D.E.S.S. equipped Can-Am vehicle, each can be programmed by your authorized Can-Am dealer to accept the other vehicle D.E.S.S. keys.

SECONDARY CONTROLS

NOTE: Some controls may not apply to your model or could be optional.

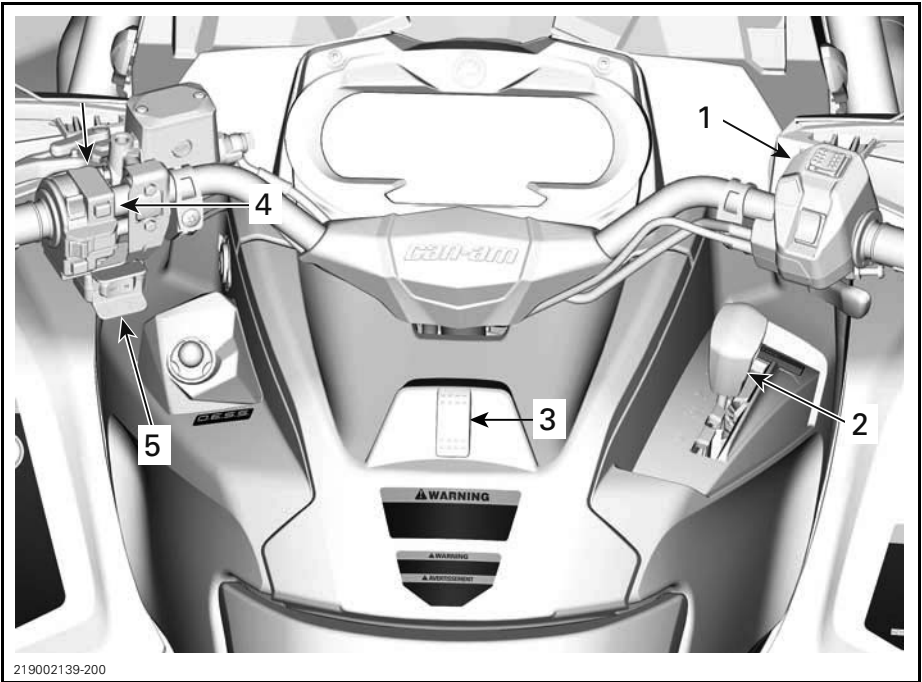

- 1. Throttle lever control housing
- 2. Shifter lever
- 3. Mode button
- 4. Multifunction switch
- 5. Winch switch

While reading this Operator's Guide, remember that:

WARNING

Indicates a potential hazard that, if not avoided, could result in serious injury or death.

1) Throttle Lever Control Housing

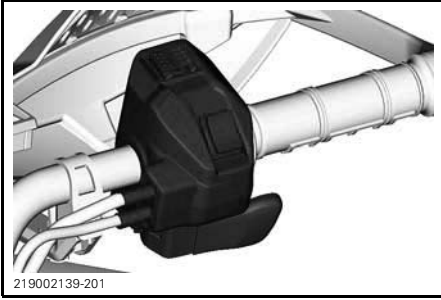

The throttle lever control switch is located on the right side of the handlebar.

2WD/4WD Selector

Models with Visco-Lok Front Differential

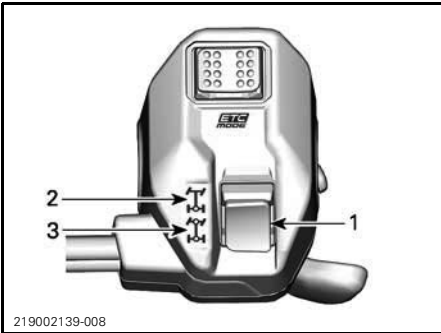

TYPICAL

1. 2WD/4WD selector
2. 2WD position
3. 4WD position

Changing Traction Mode

Before passing in 2WD or in 4WD modes:

1. Stop the vehicle completely.
2. Let the engine idling.
3. Select desired mode.

NOTICE Front differential damage may occur if the 2WD/4WD selector is used while vehicle is moving.

2WD Mode

In this mode, the engine power is transferred through the rear wheels only.

To engage the 2WD mode, press the selector **UP**.



2WD MODE - TYPICAL

4WD Mode

The engine power is distributed by both the front and the rear wheels.

To engage the 4WD mode, press the selector **DOWN**.



4WD MODE - TYPICAL

2WD/4WD/4WDLock Selector

Models with Visco-4Lok Front Differential

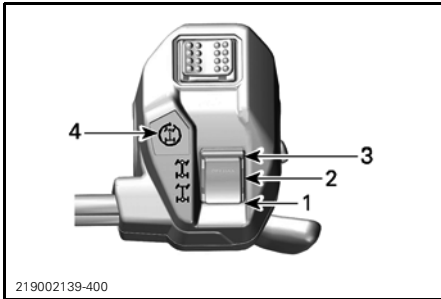

219002139-400

1. 2WD position
2. 4WD position
3. 4WDLock position
4. 4WDLock telltale

Changing Traction Mode

Before passing in 2WD or in 4WD modes:

1. Stop the vehicle completely.
2. Let the engine idling.
3. Select desired mode.

To engage or disengage the 4WDLock mode:

1. Make sure 4WD mode is selected.
2. Reduce your speed under 30 km/h (20 MPH).
3. Release the throttle.
4. Momentary fully press the selector up.
5. To disengage the 4WDLock mode, press the selector up again.

When the 4WDLock is activated, the telltale on the throttle lever control housing and the icon in the digital display will turn on.

NOTE: If the telltale flashes then stays off, the request is not acknowledged. Reduce your speed under 30 km/h (20 MPH), release the throttle and try again.

2WD Mode

In this mode, the engine power is transferred through the rear wheels only.

To engage the 2WD mode, press the selector **DOWN**.



219002139-401

2WD MODE - TYPICAL

4WD Mode

The engine power is distributed by both the front and the rear wheels.

The transfer between the front wheels is made depending on traction using the Visco-Lok system

To engage the 4WD mode, move the selector **in center**.

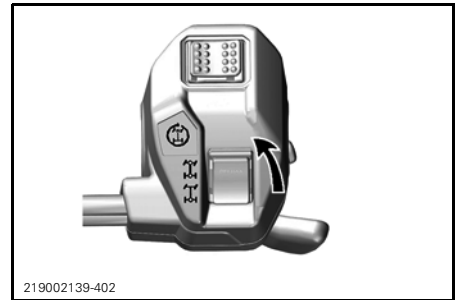

219002139-402

4WD MODE - TYPICAL

4WDLock Mode

⚠ WARNING

Changing the direction abruptly can cause loss of control or injury. Never apply the 4WDLock mode before entering a turn or during the turn. The vehicle behavior is modified when the 4WDLock mode is activated. The turning radius is also increased.

This mode is designed to lock the front differential allowing more traction to free the vehicle from a situation (ex: vehicle caught in mud or other soft terrains).

The engine power is then distributed equally at all 4 wheels.

In 4WDLock mode, a speed limiter restricts the vehicle speed to 40 km/h (25 MPH). Refer to *MULTIFUNCTION SWITCH* to have more information about how overriding this limitation.

Driving Modes Selector

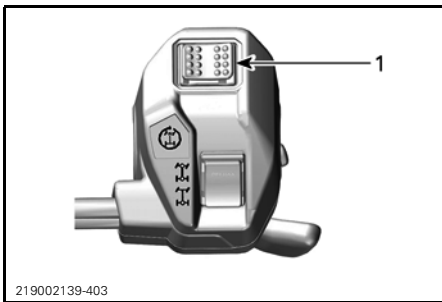

1. Driving modes selector

The driving modes selector is located on the top of the throttle lever control housing.

3 modes are available:

- Normal
- ECO
- Sport

To switch from one mode to another, toggle the selector to the left or to the right



The SPORT mode provides a crisper throttle response. Press LEFT to activate, RIGHT to deactivate.

NOTE: The SPORT mode can be activated with all key types and provides the maximum power with the used key.

The ECO mode provides a smoother throttle response and is limited to a maximum speed of 70 km/h (43 MPH). Press LEFT to activate, RIGHT to deactivate.

The NORMAL mode provides a response between SPORT and ECO.

2) Shift Lever

The shift lever is located on the RH side of the vehicle near steering column.



SHIFT LEVER LOCATION

The shift lever is used to change the gearbox position.

The shift lever has 5 positions:

SHIFT LEVER POSITIONS	
POSITION	GEAR
P	Park
R	Reverse
N	Neutral
H	High range (forward)
L	Low range (forward)



ymo2012-012-036

SHIFT PATTERN

The vehicle must be stopped and brakes applied prior to selecting any gear.

NOTICE This gearbox is not designed to shift while vehicle is moving.

P: Park

The park position locks the gearbox to help prevent vehicle movement.

⚠ WARNING

Always use the PARK (P) position when the vehicle is not in operation. The vehicle can roll if the shift lever is not set to P (PARK).

R: Reverse

The reverse position allows the vehicle to go backwards.

NOTE: In reverse operation, the engine's RPM is limited, thus limiting the vehicle reverse speed.

⚠ WARNING

When driving downhill in reverse, gravity can increase the vehicle speed above the set limited reverse speed.

Neutral

The neutral position disengages the gearbox.

⚠ WARNING

Always use the PARK (P) position when the vehicle is not in operation. The vehicle can roll if the shift lever is set to N (NEUTRAL).

High Range (Forward)

This position selects the high speed range of the gearbox. It is the normal driving speed range. It allows the vehicle to reach its maximum speed.

Low Range (Forward)

This position selects the low speed range of the gearbox. It allows the vehicle to move slowly with maximum torque at the wheels.

NOTICE Use the low speed range to pull a trailer, carry heavy cargo, go over obstacles or drive uphill and downhill.

3) Multifunction Switch

The multifunction switch is located on the LH side of the handlebar.

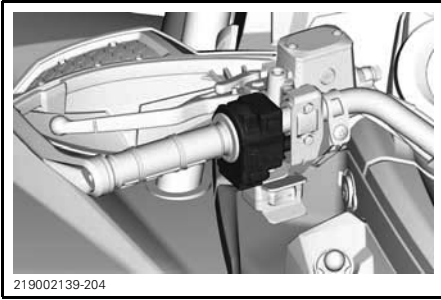

Headlight Switch



1. Light OFF
2. Low beam and taillight
3. High beam and taillight

Engine Start Button

The engine start button is located at the top of the multifunction switch.

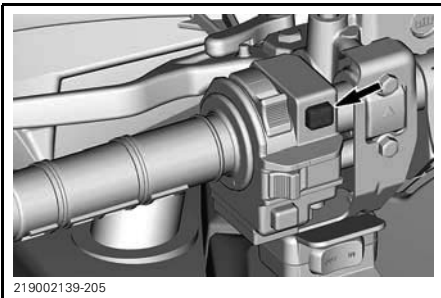

When depressed and held, it starts the engine.

NOTE: Refer to *STARTING THE ENGINE* in the *BASIC PROCEDURES* section for complete starting procedure.

Override/DPS Button

This button is located at the bottom of the multifunction switch.

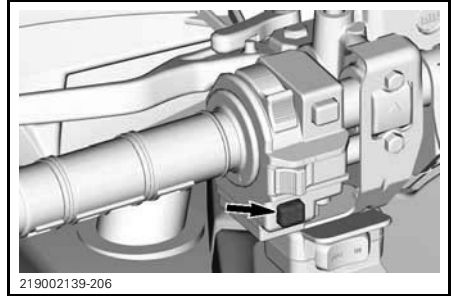

It has 2 functions.

- Activate the override function
- Change DPS modes.

Override Function

This function allows to bypass the engine speed limiter when the vehicle is used in reverse or in the 4WDLock mode.

In 4WDLock, the override mode will allow to reach an other speed limitation:

- 60 km/h (37 MPH) in HIGH or LOW gear
- 25 km/h (16 MPH) in reverse.

⚠ WARNING

Make sure the area around the vehicle is clear before using the override mode.

The override mode must be used only at low speed and when the vehicle is caught in mud or other soft terrain.

Do not use the override mode when driving normally in reverse, this would result in excessive speed,

Do not use the override mode when driving normally in 4WD-Lock, otherwise a loss of control could occur.

To engage the override function, proceed as follows:

1. Ensure that the vehicle is completely stopped.
2. Press and hold the override/DPS button then press the throttle lever gradually.

NOTE: When using the override function, the gauge will scroll an **OVER-RIDE** message to confirm that the function is activated.

3. To disengage the override function, simply release the override/DPS button.

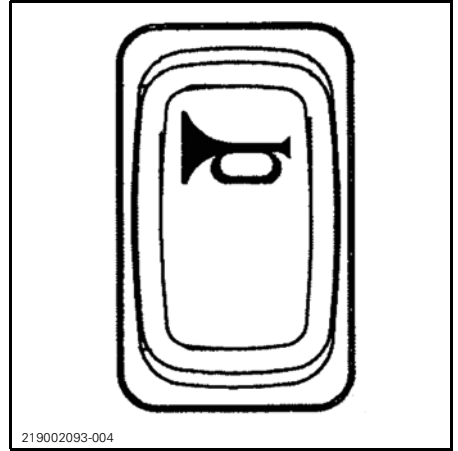

DPS Function

This button is also used to change the Dynamic Power Steering (DPS) mode.

For complete information on DPS modes, refer to *TUNE YOUR RIDE*.

Winch Control Switch (If Equipped)

This switch is located under the multi-function switch.

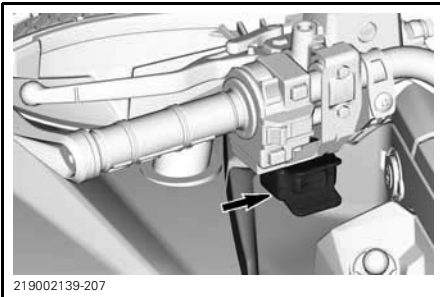

This switch is used to unwind or rewind the winch cable.

- Press left to unwind the cable.
- Press right to rewind the cable.

Horn Switch (Not shown)

For vehicles sold in Finland Only

Press on the horn switch to activate the horn.

EQUIPMENTS

NOTE: Some equipments may not apply to your model or could be optional.

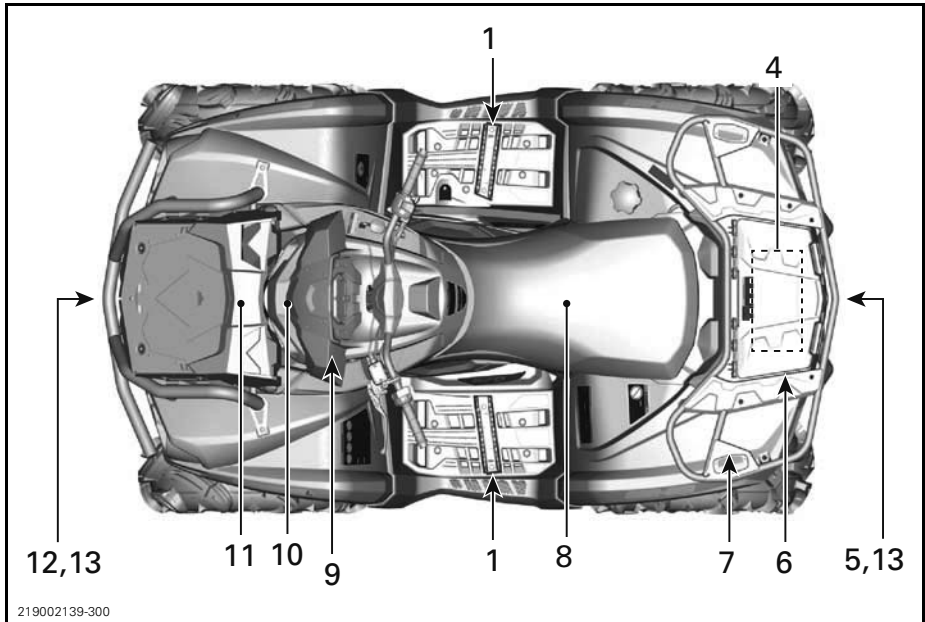

TYPICAL - 570 MODELS

While reading this Operator's Guide, remember that:

WARNING

Indicates a potential hazard that, if not avoided, could result in serious injury or death.

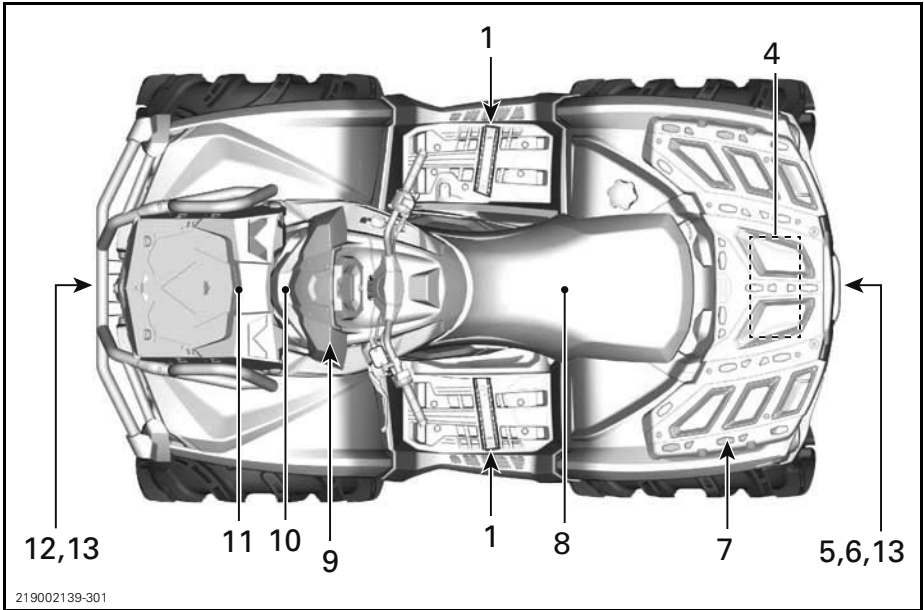

TYPICAL - 650 AND 850 MODELS

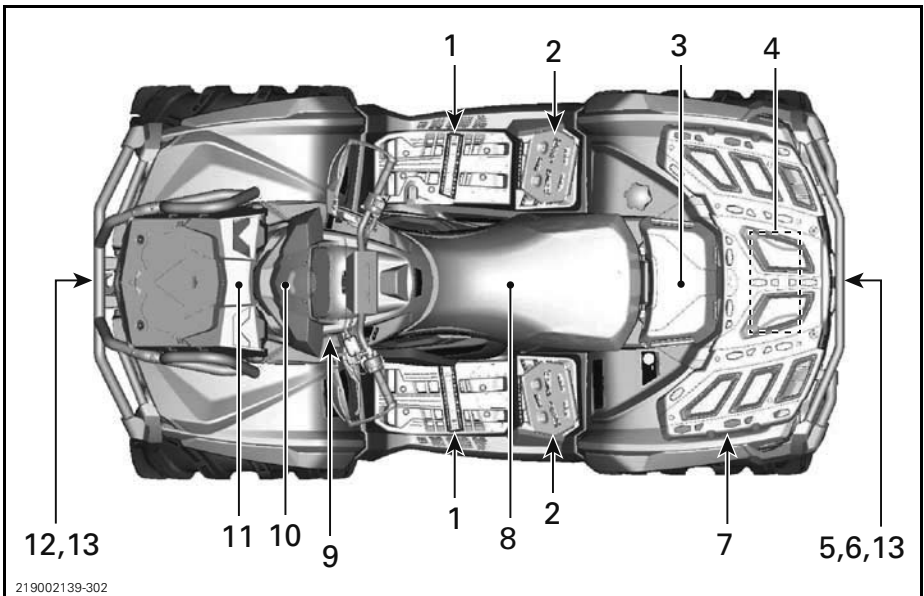

TYPICAL - 1000R MODELS

1) Footpegs

The footpegs are located on the RH and LH footrests.

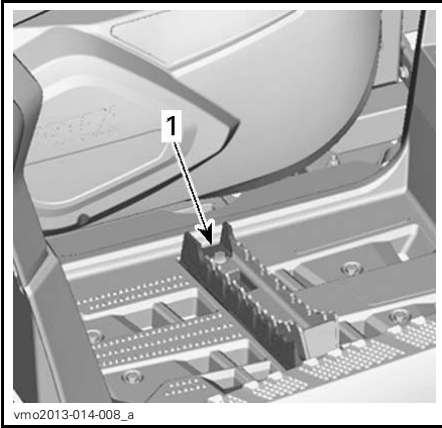

1. Footpeg

⚠ WARNING

Operator must have both feet on footpegs at all times during vehicle operation.

2) Mud Riding Footrests

1000R models only

The mud riding footrests are located behind the footpegs.

They provide assistance to the operator for riding in mud.



1. Mud riding footrest

3) Glove Box

1000R models only

Glove Box Opening

To open glove box, unlock latch on each side of glove box and open lid.

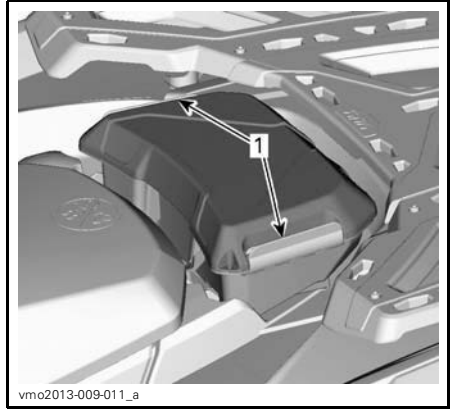

1. Latches

Glove Box Removal

1. Unlock latch on each side of glove box and open lid.
2. Turn latch counter clockwise to unlock.

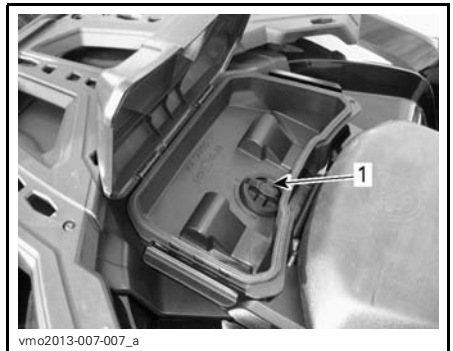

1. Latch

3. Remove glove box.

⚠ WARNING

Never carry a passenger on this vehicle.

Glove Box Installation

1. Open glove box cover and turn latch to the unlock position.
2. Align and insert glove box latching system into the vehicle's "LINQ" opening.

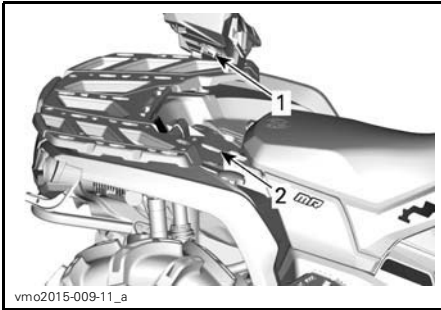

1. *Glove box latch*
2. *"LINQ" opening*

3. Turn latch clockwise to the lock position.

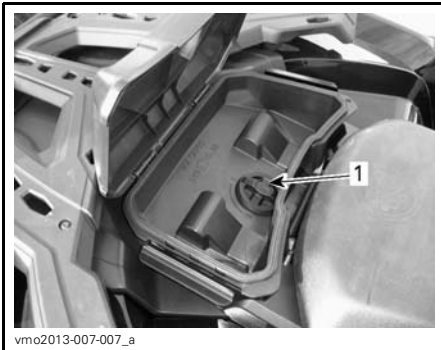

1. *Latch*

4. Close cover and verify if glove box is locked in position.



1. *Glove box*

4) Tool kit

The tool kit is located in the rear storage compartment. It contains tools for basic maintenance.

5) Trailer Hitch

Convenient hitch to install a ball to tow a trailer or other equipment. Install the proper ball size as per trailer manufacturer recommendations. Refer to *SPECIFICATIONS* for carrying loads and towing recommendations.



- TYPICAL - 1000R MODEL SHOWN*
1. *Trailer hitch*

⚠ WARNING

Ensure to install the proper ball size that matches the equipment you will tow.

NOTE: Follow manufacturer's instructions for proper attachment.

6) Rear Storage Compartment

Rear Storage Compartment

Convenient location to carry personal articles.



570 MODELS

1. Rear storage compartment cover



TYPICAL ALL EXCEPT 570 MODELS

1. Rear storage compartment cover

⚠ WARNING

Always engage the PARK position on the shift lever before opening cover. Never leave any heavy or loose breakable objects in the storage area. Always latch cover before riding.

To Open Rear Storage Compartment 570 Models

Unlatch cover and gently lift cover.



1. Rear storage compartment latch

All except 570 Models

Unlatch cover and gently lower cover.



1. Rear storage compartment latch

To Close Rear Storage Compartment 570 Models

Gently lower and latch cover.

All except 570 Models

Gently lift and push cover until the latch clicks two times to ensure the seal is compressed.

7) Cargo Rack

Cargo racks are convenient for carrying equipment and various other cargo. They must never be used to carry a passenger.

⚠ WARNING

- Never carry a passenger on a cargo rack.
- Cargo must never interfere with the drivers line of sight or affect his ability to properly steer the vehicle.
- Do not overload the vehicle.
- Always ensure all cargo is properly secured and does not extend out pass the racks.

Refer to *SPECIFICATIONS* for cargo weight recommendations.

8) Seat**Seat Removal**

To remove the seat, pull its latch upward. This latch is located underneath the rear of seat.

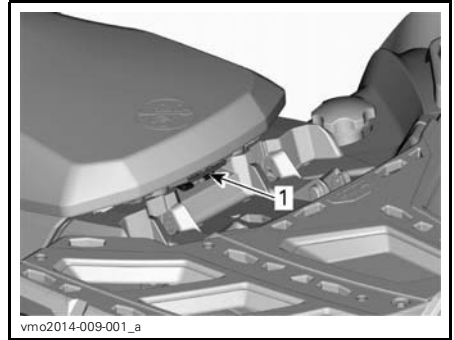
**TYPICAL**

1. Seat latch

Pull seat upward then rearward. Continue lifting movement until you can release the front retaining device then completely remove seat.

Seat Installation

Insert front tabs of seat into steel hooks of frame. When seat rests in its position, firmly push seat down to latch.

NOTE: A distinctive snap will be felt. Double check that the seat is secure by giving it a tug to confirm proper latching.

⚠ WARNING

It is of the upmost importance for the operator's safety that you confirm that the operator's seat is properly locked in position by pulling back and up several times.

9) 12-Volt Power Outlet

Convenient for handheld spotlight or other portable equipment.

Remove protective cap to use. Always reinstall it after use to protect against weather.

While reading this Operator's Guide, remember that:

⚠ WARNING

Indicates a potential hazard that, if not avoided, could result in serious injury or death.

10) Gauge Support

Gauge Support Removal

Lift the rear of gauge support, then push forward.

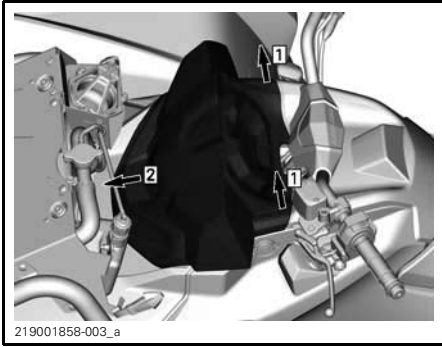

Gauge Support Installation

Slide the gauge support backwards to hook the front tabs.

Push the rear of gauge support to secure it.

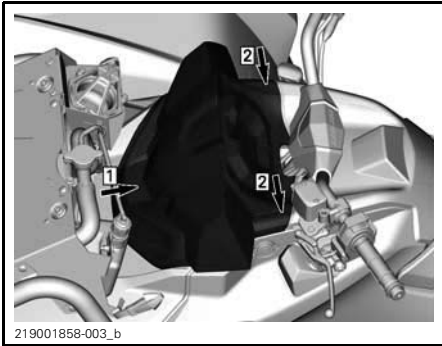

11) Radiator Cover

Radiator Cover Removal

Detach the rubber latches on both sides.

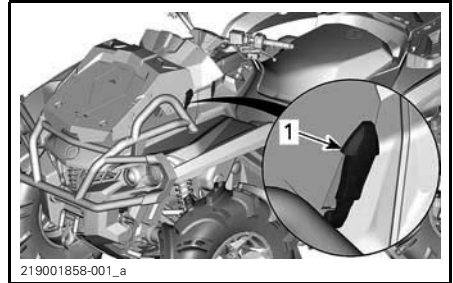

1. Rubber latch

Lift the rear of cover, then pull backwards.

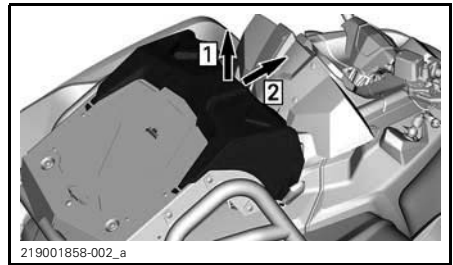

Step 1: Lift
Step 2: Pull backwards

Radiator Cover Installation

Insert the cover tabs in the protector slots.

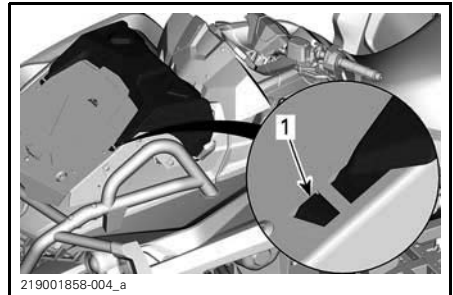

1. Cover tab

Attach the rubber latches on both sides.

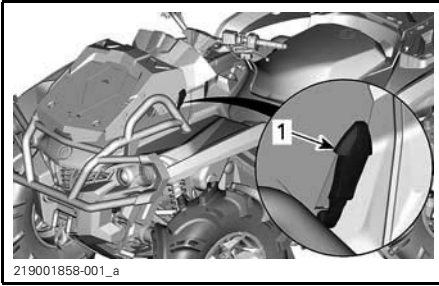

1. Rubber latch

12) Winch (If Equipped)

The winch can be actuated using the winch control switch or with the remote control (sold separately).

NOTE: Using the winch intensively over a long period of time may discharge the battery.

The following tips will help to reduce the risk of discharging the battery:

Unwind manually: Unlock the cable using the handle then pull on the hook strap to unreel.

It is recommended to let the engine run while winching or rewinding. Do not stop the engine immediately after winching to let battery recharge.

Also, when winching for more than 30 seconds, it is recommended to increase engine RPM in the range of 3000 RPM to increase charging power to the battery.

NOTE: Make sure vehicle is in NEUTRAL (N) before increasing engine RPM.

A roller fairlead is installed to prevent damage to the vehicle and to guide the wire rope into the winch.

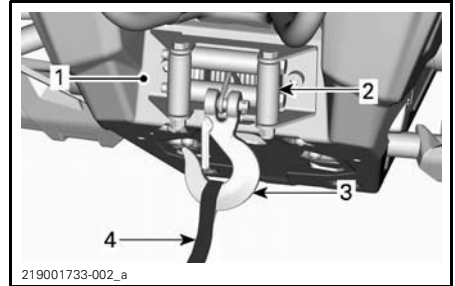

1. Winch
2. Roller fairlead
3. Winch hook
4. Hook strap

Refer to the *WINCH GUIDE*, supplied with the vehicle, for more information about the winch.

13) Recovery Hooks

Convenient hook that can be use to recover a stuck ATV.

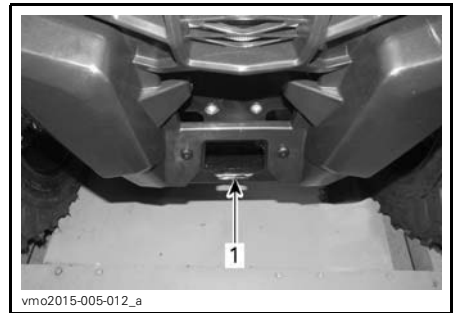

TYPICAL - 570 MODELS
1. Front recovery hook



vmo2013-009-014_a

TYPICAL - ALL EXCEPT 570 MODELS

1. Front recovery hook



vmo2015-005-013_a

TYPICAL - 570 MODELS

1. Rear recovery hook

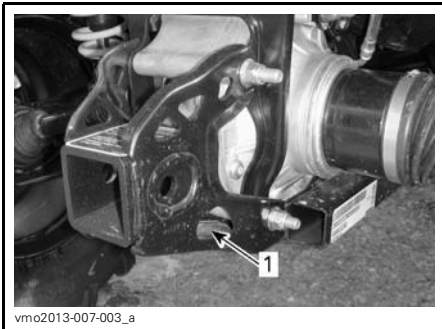

vmo2013-007-003_a

TYPICAL - ALL EXCEPT 570 MODELS

1. Rear recovery hook

MULTIFUNCTION GAUGE (LCD)

⚠ WARNING

Reading the multifunction gauge display can distract from the operation of the vehicle, particularly from constantly scanning the environment.

Multifunction Gauge Description

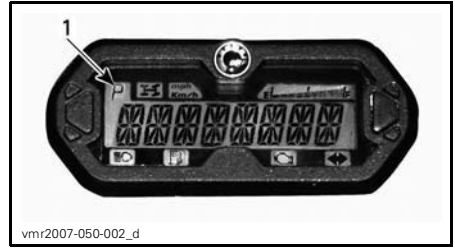
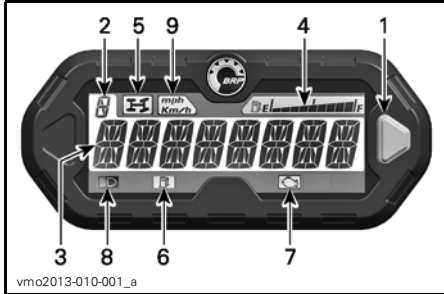

1. Transmission position

DISPLAY	FUNCTION
P	Park
R	Reverse
N	Neutral
H	High range
L	Low range

1. Selector button
2. Gearbox position display
3. Main screen
4. Fuel level display
5. 4WD indicator lamp
6. Low fuel level indicator lamp
7. Check engine indicator lamp
8. High beam indicator lamp
9. MPH, Km/h indicator lamp

1) Selector Button

The selector button is used to navigate or change settings in the multifunction gauge.

2) Gearbox Position Display

This display shows the selected gearbox position.

3) Main Screen

The main screen is used to display numerous functions of the multifunction gauge.

Refer to *MULTIFUNCTION GAUGE MODES* for the different available modes:

4) Fuel Level Display

Bar gauge that continuously indicates the level of fuel in the fuel tank while riding.

While reading this Operator’s Guide, remember that:

⚠ WARNING

Indicates a potential hazard that, if not avoided, could result in serious injury or death.

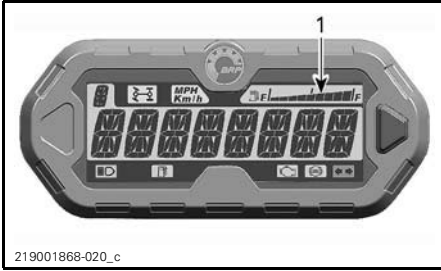

219001868-020_c

1. Fuel level display

5) 4WD Indicator Lamp



When this indicator is ON, it indicates the 4WD mode is selected.

6) Low Fuel Level Indicator Lamp



When this indicator is ON, it indicates that there is approximately 5 L (1.3 U.S. gal.) of fuel left in fuel tank.

7) Check Engine Indicator Lamp



When this indicator is ON, it indicates an engine fault code, look for a message at the LCD display.

When this indicator blinks, it indicates that the **LIMP HOME** mode is activated.

Refer to *TROUBLESHOOTING* for more details.

8) High Beam Indicator Lamp



When this indicator is ON, it indicates that **high beam** is selected on the headlights.

9) KM/H or MPH Indicator Lamp

mph
Km/h

The proper lamp turns on to indicate the unit the speedometer uses.

Multifunction Gauge Modes

Speedometer Mode

In this mode, the main screen displays the actual vehicle speed in km/h or in mph.



Tachometer Mode

In this mode, the main screen displays the actual engine speed in revolutions per minute (RPM).



Combined Mode

In this mode, the main screen displays both the vehicle speed and the engine speed (RPM).

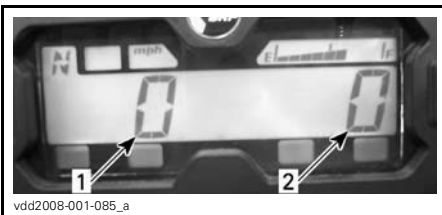

1. Vehicle speed
2. Engine speed (RPM)

Odometer (OD)

Odometer records the total distance travelled either in miles or kilometers.



Clock

Displays current time.



Refer to *GAUGE SETUP* to set current time.

Trip Meter (TP)

The trip meter records the travelled distance since it has been reset. Distance travelled is displayed either in kilometers or miles.



Press and HOLD the selector button for 2 seconds to reset the trip meter.

Trip Hour Meter (TH)

The trip hour meter records vehicle running time when the electrical system is activated. It can be used to establish traveling time between 2 places.



Press and HOLD the selector button for 2 seconds to reset the hour meter.

Engine Hour Meter (EH)

The engine hour meter records engine running time.



Message Display Mode

If an abnormal engine condition occurs, a message may scroll across the main screen in conjunction with a pilot lamp. Refer to *TROUBLESHOOTING* for details.

Fault Code Mode

Switch to HI beam and select engine hour meter display. Press and hold selector button while switching high and low beam (three cycles) to access diagnostic fault codes.

Driving Modes (If equipped)

Some models are equipped with a driving mode selector.



1. Driving mode selector

A message of the selected mode will be displayed at activation and deactivation as follow:

DRIVE MODE	MESSAGE AT ACTIVATION
Eco	ECO MODE
Sport	SPORT MODE
Normal	NORMAL MODE

Navigating in the LCD Gauge

Default Display Mode

After vehicle startup, the default display mode is either:

- Vehicle speed
- Engine revolutions per minute (RPM)
- Both parameters simultaneously (combined mode).

To change from one display to the other, proceed as follows.

1. Turn ignition key to ON to power-up the system (570) or refer to *WAKING UP THE ELECTRICAL SYSTEM* (650/850/1000R).
2. Wait until the “greeting message” has been displayed.
3. Press and release selector button once to display OD (odometer).
4. Press and HOLD selector button for 2 seconds.

This will change the Mode to either Speed, RPM or Combined.



5. To select another mode, repeat steps 3 and 4 until the desired mode is displayed.

Temporary Display Mode

In the temporary display mode, the following functions are available:

- Odometer
- Clock
- Trip meter (resettable)
- Trip Hour meter (resettable)
- Engine hour meter.

Press and release selector button to change the default display mode to the temporary mode.

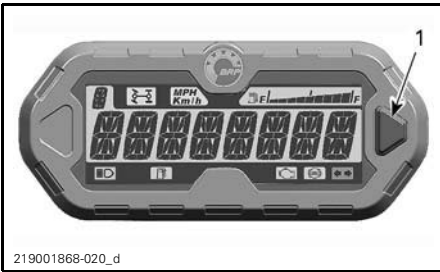

1. Selector button

The gauge will display the selected mode for 10 seconds then will return to the normal display mode.

While in a resettable mode, push and HOLD selector button for 2 seconds to reset it.

Gauge Setup

Clock Setting Using Gauge Selector Button

To set current time, proceed as follows:

1. Select the clock display.

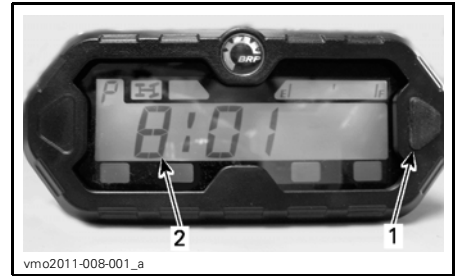

1. Selector button

2. Time

2. Press and HOLD selector button.

NOTE: The display will flash.

3. Choose the 12-hour (12H) or 24-hour (24H) format by pressing button.

4. If the 12-hour format was selected, choose Am (A) or Pm (P) by pressing button.

5. Choose hour first digit by pressing button.

6. Choose hour second digit by pressing button.

7. Choose minutes first digit by pressing button.

8. Choose minutes second digit by pressing button.

NOTE: The gauge will display the current time for 10 seconds then will return to the normal display mode.

Unit Selection (km/h vs mph)

The speedometer, odometer and trip meter are factory preset in **miles** but it is possible to change them to **kilometer** reading. Contact an authorized Can-Am dealer.

Language Selection

The gauge display language can be changed. Refer to an authorized Can-Am dealer for language availability and setup the gauge to your preference.

4.5" DIGITAL DISPLAY

Multifunction Display

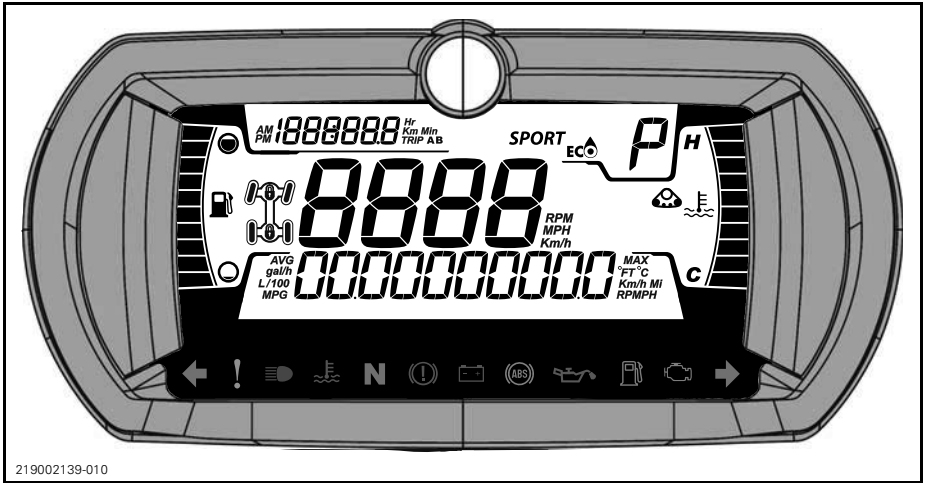

⚠ WARNING

Reading or tempering with the multifunction gauge can distract you from the operation of the vehicle, particularly from constantly scanning the environment. Always pay attention to road conditions, ensure your environment is clear and free from obstacles. Furthermore, when riding, only glance at the multifunction gauge briefly to maintain awareness of road conditions.

The multifunction gauge includes digital gauges (temperature and tachometer), telltale lights, icons and a digital screen to see important information (speed, RPM, etc.).

Lower Display

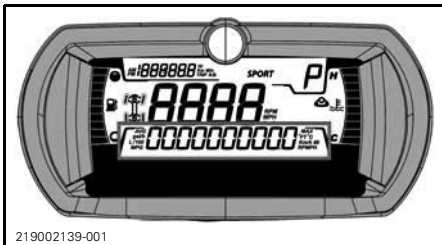

May display the following:

- RPM
- Speed
- Engine Temperature
- Battery Voltage
- Settings
- Messages

While reading this Operator's Guide, remember that:

⚠ WARNING

Indicates a potential hazard that, if not avoided, could result in serious injury or death.

Left Lateral Display

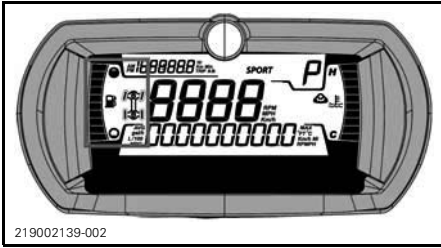

The left lateral display includes:

- Fuel level indicator
- 2X4 / 4X4 telltale

ICON	DESCRIPTION
	2x4 icon
	4X4 icon (except European Community countries)
	4X4 icon for European community

Right Lateral Display

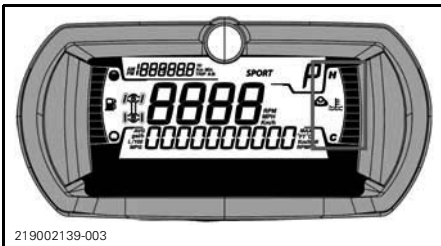

The right lateral display includes:

- Engine Temperature
- Track Kit active

When a track kit is installed, a message will scroll in the lower display.

Central Display

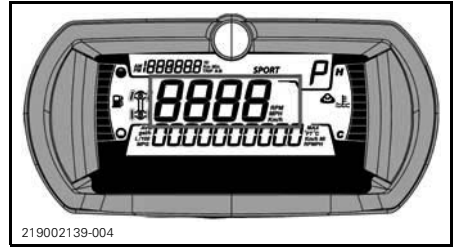

Display the vehicle speed in Km/h or MPH.

Transmission Position Display

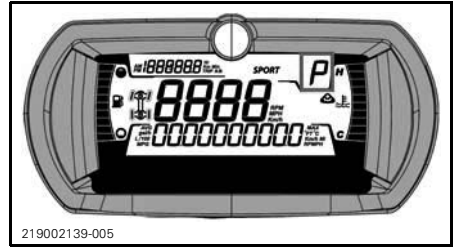

This display indicates the gear position of the gearbox:

- P (Park)
- R (Reverse)
- N (Neutral)
- H (High Range)
- L (Low Range)
- - (Invalid Range)

MODE Display

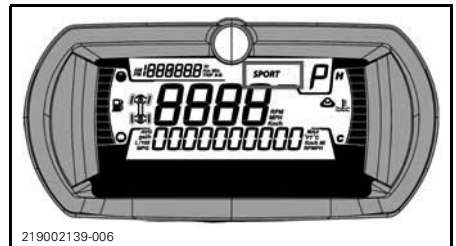

The MODE display indicates the selected driving mode:

- SPORT
- WORK

NOTE: When in NORMAL mode, no information is displayed.

A message of the selected mode will be displayed on the lower display at activation and deactivation as follow:

DRIVE MODE	MESSAGE AT ACTIVATION	MESSAGE AT DEACTIVATION
Sport	Sport	Sport OFF
Work	Work	Work OFF
Normal	Sport OFF or Work OFF	Sport or Work

Trip Display

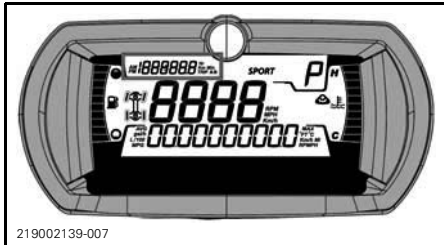

This display shows trip informations:

- Cumulative distance odometer
- Trip A
- Trip B
- Cumulative hours
- Clock

Use UPPER (TRIP) button to change the displayed information.

Hold UPPER (TRIP) button to reset Trip A/B meters.

Warning Lamps and Indicators

The following indicator lamps will alert you to a vehicle condition that may become serious. Some lamps will il-



luminate when starting the vehicle to make sure they work. If any lamps remain on after starting the vehicle, refer to the respective system warning lamp for further information.

NOTE: Some warning indicators appear in the display of the multifunction gauge and function the same as an indicator lamp but do not display when starting the vehicle.

Telltale Lights - Lower Bar



LIGHTS	DESCRIPTION
	T models only GREEN - Left or right turn signal is turned on, Hazard Warning Flasher (if equipped) - All front and rear turn signals will flash
	ORANGE - Vehicle malfunction
	BLUE - The high beam are selected
	RED - The engine temperature is too high.
	RED - Park position lever is engaged or malfunction of the brake system
	RED - If illuminate while driving, it indicates a malfunction. Turn off all unnecessary electrical equipment and have the electrical and charging systems checked.
	T models only ORANGE - Malfunction of the ABS system

LIGHTS	DESCRIPTION
	<p>RED - If illuminate while the engine running or while driving, this indicates a malfunction. Stop the vehicle as soon as it is safe to do so and turn the engine off. Check the engine oil level. Have the lubrication system checked as soon as possible, even if the level being correct.</p>
	<p>ORANGE - Illuminate when the fuel level is low or when the fuel tank is near empty. Refuel as soon as possible.</p>
	<p>ORANGE</p> <p>Turn on: Malfunction of the vehicle emissions control system</p> <p>Blink: Engine limitation, the limp home mode is activated. Have the vehicle serviced immediately.</p>

Icons and Indicators - Multifunction Display

ICONS AND INDICATORS	
SPORT	Denotes SPORT mode is selected.
WORK	Denotes WORK mode is selected.
	Track kit active (If equipped)

Settings

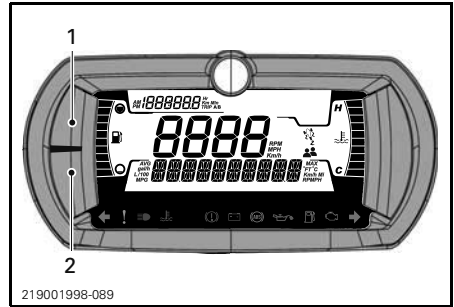

1. UPPER button
2. LOWER button

Display Brightness

The brightness of the display is factory setup by default at the maximum level. The brightness may be modified by an authorized Can-Am Off-road dealer.

Setting Language

The language of the display is factory setup by default in English. See an authorized Can-Am Off-Road dealer for available languages and change the setup at your convenience.

Menu Buttons

Upper Button

The following informations may be displayed by pressing the UPPER button:

- Odometer - Cumulative distance
- Trip A
- Trip B
- Clock.

Lower Button

The following informations may be displayed by pressing the LOWER button:

- RPM
- Fuel Statistic (average)

- Autonomy (km or Mph)
- Settings.
 - Reset Maintenance
 - Fault codes
 - Units
 - Reset Statistics
 - Clock settings
 - Exit

The LOWER button may also be used to select a driving mode.

570 and non-NRMM Compliant Models

Hold the button for 1 second to change DPS mode.

850, 1000R and NRMM Compliant Models

Hold the button for 1 second to reset the maximum and the averaged speed.

How Choosing, Resetting or Changing a Value

Upper Menu

Press on the UPPER button until the information to display are selected.

To Reset Trip A or B

Select trip A or B.

Press and hold the UPPER button until the value is reset.

Lower Menu

To Select Specific Information

Press the LOWER button until the name of the desired information is displayed.

Except for SETTINGS, wait 2-3 seconds to select and view the information.

To enter in the SETTINGS menu, hold the LOWER button 2-3 seconds.

NOTE: If no selection is done within 10 seconds, the cluster go out of the SETTINGS menu

To Reset a Value (AVG)

Select the value to be reset.

Press and hold the LOWER button until the value is reset.

To Modify a Value (Clock)

Press the LOWER button to select the information to be modified.

When selected, hold the LOWER button to enter in the modification mode.

Press LOWER button until the new value is displayed.

Wait 2-3 second to accept the change.

How Selecting or Change the Driving Mode

Press and hold the LOWER button until the message in the lower display changes.

Press the LOWER button to scroll all available driving modes.

Wait 2-3 seconds to select and view the new information.

7.6" DIGITAL DISPLAY

Multifunction Display

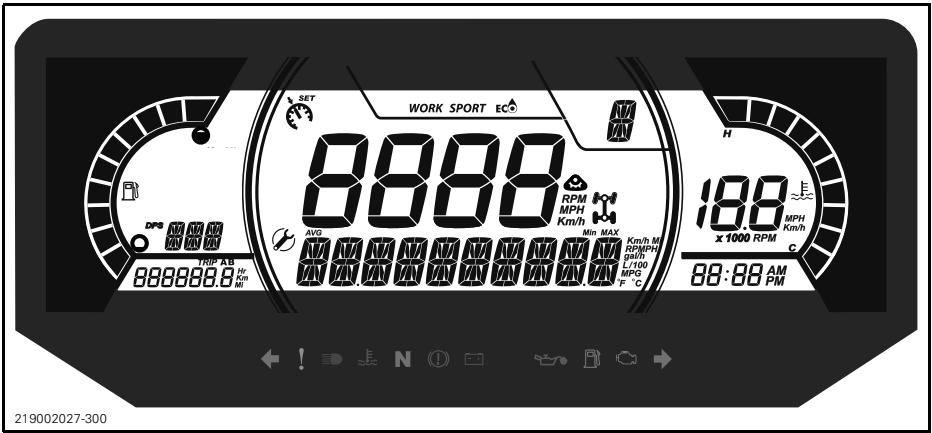

⚠ WARNING

Reading or tempering with the multifunction gauge can distract you from the operation of the vehicle, particularly from constantly scanning the environment. Always pay attention to road conditions, ensure your environment is clear and free from obstacles. Furthermore, when riding, only glance at the multifunction gauge briefly to maintain awareness of road conditions.

Lower Display



- Settings
- Messages

The SPEED STAT display shows the maximum and the average speed. Hold MENU or OK button for 1 second to reset.

May display the following:

- RPM
- Speed statistics
- Engine Temperature
- Battery Voltage

While reading this Operator's Guide, remember that:

⚠ WARNING

Indicates a potential hazard that, if not avoided, could result in serious injury or death.

Left Lateral Display

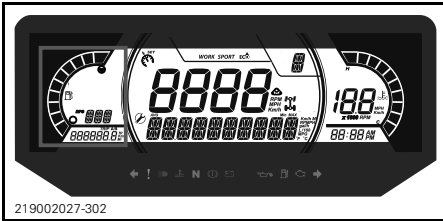

219002027-302

The left lateral display includes:

- Fuel level indicator
- Tripmeter (A - B)
- Odometer
- Vehicle Hour meter
- DPS indicator

Right Lateral Display



219002027-303

The right lateral display includes:

- Engine Temperature
- Clock
- Speed indicator

The speed indicator in this display is activated when the central display shows informations other than the speed. Otherwise it is blank.

Central Display



219002027-304

May display the following:

- RPM
- Vehicle speed

Transmission Position Display



219002027-305

This display shows gears position of gearbox:

- P (Park)
- R (Reverse)
- N (Neutral)
- H (High range)
- L (Low range)
- – (Invalid gear)

MODE Display



219002027-306

The MODE display indicates the selected mode of operation:

- SPORT
- ECO

To change between modes, press the selector on the left or right.



RH SIDE OF HANDLEBAR
1. Driving modes selector

A message of the selected mode will be displayed on the lower display at activation and deactivation as follow:

DRIVE MODE	MESSAGE AT ACTIVATION	MESSAGE AT DEACTIVATION
Sport	Sport	Sport OFF
ECO	ECO	ECO OFF

Middle Right Display



The middle right display indicates the selected mode of operation:

- 2X4
- 4X4
- Track Kit active

ICON	DESCRIPTION
	2x4 icon
	4X4 icon (except European Community countries)
	4X4 icon for European community
	Track kit icon

Middle Left Display

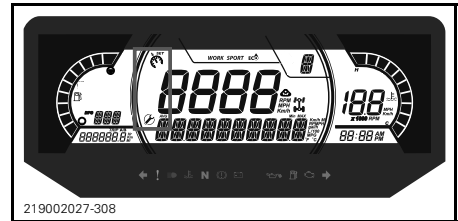

- The middle left lateral display includes:
- Maintenance reminder
 - Speed limiter (ABS models only)

Warning Lamps and Indicators

The following indicator lamps will alert you to a vehicle condition that may become serious. Some lamps will illuminate when starting the vehicle to make sure they work. If any lamps remain on after starting the vehicle, refer to the respective system warning lamp for further information.

NOTE: Some warning indicators appear in the display of the multifunction gauge and function the same as an indicator lamp but do not display when starting the vehicle.

Telltale Lights - Lower Bar





LIGHTS	DESCRIPTION
	T models only GREEN - Left or right turn signal is turned on,
	Hazard Warning Flasher (if equipped) - All front and rear turn signals will flash
	ORANGE - Vehicle malfunction
	BLUE - The high beam are selected
	RED - The engine temperature is too high.
	RED - Park position lever is engaged or malfunction of the brake system
	RED - If illuminate while driving, it indicates a malfunction. Turn off all unnecessary electrical equipment and have the electrical and charging systems checked.
	T models only ORANGE - Malfunction of the ABS system

LIGHTS	DESCRIPTION
	RED - If illuminate while the engine running or while driving, this indicates a malfunction. Stop the vehicle as soon as it is safe to do so and turn the engine off. Check the engine oil level. Have the lubrication system checked as soon as possible, even if the level being correct.
	ORANGE - Illuminate when the fuel level is low or when the fuel tank is near empty. Refuel as soon as possible.
	ORANGE Turn on: Malfunction of the vehicle emissions control system Blink: Engine limitation, the limp home mode is activated. Have the vehicle serviced immediately.

Icons and Indicators - Multifunction Display

ICONS AND INDICATORS	
SPORT	Denotes SPORT mode is selected.
ECO	Denotes ECO mode is selected.
WORK	Denotes Work mode is selected

ICONS AND INDICATORS	
	When lit, indicates that a maintenance is required. See your authorized Can-Am dealer or person of your own choosing for the maintenance.
	Track kit active (If equipped) (For all except T Category models)
	Denotes Speed limiter is selected (T Category models only)

Settings

The button to navigate through menus is located under the handlebar, on the console.

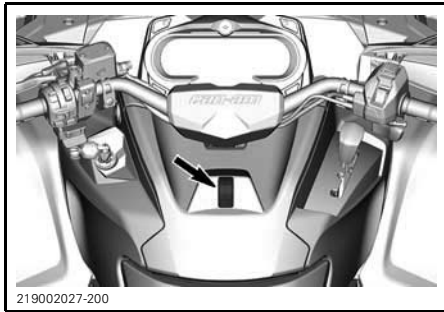

Setup

Using MENU button, select **SETTINGS** and hold to enter setting menu.

Maintenance Reset

NOTE: Only when the maintenance icon is displayed.

Using MENU button, select **RES MAINT** and hold to reset maintenance.

Fault Codes

NOTE: Only when fault codes are actives.

Using MENU button, select **CODES** and hold to see active and occurred fault codes. Fault codes will be scrolled on the Lower Display.

Speed Limiter Mode

Speed limiter mode allows the operator to set the desired maximum speed.

This is useful when operating in limited speed zones.

The operator must keep the throttle depressed to maintain forward speed.

Once the maximum speed is set, the operator can vary the from stopped to the set speed using the throttle. The set speed will be exceeded when the throttle is fully depressed, at that time, the speed limiter will be temporary deactivated (the icon will be blinking) until vehicle speed is under or equal the speed limiter's set point.

As you proceed under a constant speed setting, keep your attention level up to maintain good situational awareness.

Slowing down is a matter of releasing the throttle.

Activating Speed Limiter Mode

- Using MENU button, select **SETTINGS** and hold to enter setting menu.
- Select **SPEED LIM** and your desired speed
 - In Metric
 - Between 30 km/h and 100 km/h by increments of 10 km/h, or
 - Unlimited
 - In Imperial
 - Between 20 mph and 65 mph by increments of 5 mph, or
 - Unlimited

Speed limiter indicator will be lit.

**TYPICAL****1. Speed limiter INDICATOR**

Hold MENU button to confirm selected speed limit.

NOTE: Activating speed limiter mode of operation only limits the maximum speed available when depressing the throttle. The throttle must be held in to maintain forward speed. Speed can be varied from idle up to the set speed using the throttle once the speed limiter function is activated.

Deactivating Speed Limiter Mode

To deactivate speed limiter mode, in *SETTINGS*, select *SPEED LIM* and then select the -- (unlimited) limit.

Speed/RPM

The speed and RPM display can be swapped.

Using MENU button, select **SPEED/RPM** and hold button to invert speed and RPM display.

Unit Selection

This multifunction gauge is factory preset in Imperial units but it is possible to change it to Metric units.

Using MENU button, select **UNITS** and hold button to change units.

Reset Stats

Using MENU button, select **RESET STAT** and hold to reset.

Setting Brightness

The brightness of the LCD display can be adjusted.

Using MENU button, select **BRIGHTNESS** and hold MENU button to change brightness.

Using MENU button, adjust brightness then push and hold MENU button to acknowledge selection.

Setting Clock

Using MENU button, Select **CLOCK** and hold to change time.

1. Press MENU button to select clock display.
2. Push and hold MENU button for 1 second.
3. Press MENU button to select 12:00 AM PM or 24:00 time base (time flash).
4. Push and hold MENU button to acknowledge selection.
5. Press MENU button to change hours (hours flash).
6. Push and hold MENU button to acknowledge hour selection
7. Push MENU button to change to minutes (minutes flash).
8. Press and hold MENU button to acknowledge minutes selection.

Setting Language

The gauge display language can be changed. Refer to an authorized Can-Am dealer for language availability and to setup the gauge to your preference.

DPS Modes

The lower display can show which DPS mode is active. Refer to *TUNE YOUR RIDE*.

FUEL

Fuel Requirements

NOTICE Always use fresh gasoline. Gasoline will oxidize; the result is loss of octane, volatile compounds, and the production of gum and varnish deposits which can damage the fuel system.

Alcohol fuel blending varies by country and region. Your vehicle has been designed to operate using the recommended fuels, however, be aware of the following:

- Use of fuel containing alcohol above the percentage specified by government regulations is not recommended and can result in the following problems in the fuel system components:
 - Starting and operating difficulties.
 - Deterioration of rubber or plastic parts.
 - Corrosion of metal parts.
 - Damage to internal engine parts.
- Inspect frequently for the presence of fuel leaks or other fuel system abnormalities if you suspect the presence of alcohol in gasoline exceeds the current government regulations.
- Alcohol blended fuels attract and hold moisture which may lead to fuel phase separation and can result in engine performance problems or engine damage.

Recommended Fuel

Use unleaded gasoline containing MAXIMUM 10% ethanol. The gasoline must have the following minimum octane requirements:

For 570, 650 and 850 engines use common unleaded gasoline with an AKI (R+M)/2 octane rating of 87, or an RON octane rating of 92.

For 1000R engines use premium unleaded gasoline with an AKI (R+M)/2 octane rating of 91, or a RON octane rating of 95.



NOTICE Never experiment with other fuels. Engine or fuel system damages may occur with the use of an inadequate fuel.

NOTICE Do NOT use fuel from fuel pumps labeled E85.

Use of fuel labeled E15 is prohibited by U.S. EPA Regulations.

Fueling Procedure

WARNING

- Fuel is flammable and explosive under certain conditions.
- Never use an open flame to check fuel level.
- Never smoke or allow a flame or spark in the vicinity.
- Always work in a well-ventilated area.

NOTICE Always clean the surrounding of the fuel cap of any debris, dust, sand to avoid contaminating fuel.

1. Stop engine.

WARNING

Always stop engine before refueling.

2. Do not allow anyone to remain seated on the vehicle while fuelling.

3. Slowly unscrew fuel tank cap counterclockwise to remove it.

⚠ WARNING

If a differential pressure condition is noticed (whistling sound heard when loosening fuel tank cap) have vehicle inspected and/or repaired before further operation.

4. Insert the spout in the filler neck.
5. Pour fuel slowly to allow time for the air in the tank to escape and prevent fuel flow back. Be careful not to spill fuel.
6. Stop fuelling when the fuel reaches the bottom of filler neck. **Do not overfill.**

⚠ WARNING

Always wipe off any fuel spillage from the vehicle.

7. Fully tighten fuel tank cap clockwise.

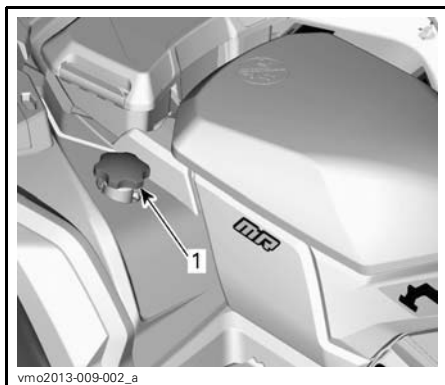

TYPICAL - 1000R MODEL SHOWN

1. Fuel tank cap

⚠ WARNING

Never top up the fuel tank before placing the vehicle in a warm area. As temperature increases, fuel expands and may overflow.

BREAK-IN PERIOD

Operation During Break-In

A break-in period of 10 operating hours or 300 km (200 mi) is required for the vehicle.

Engine

During the break-in period:

- Avoid full throttle operation.
- Maximum throttle should not exceed 3/4.
- Avoid sustained accelerations.
- Avoid prolonged cruising speeds.
- Avoid engine overheating.

However, brief accelerations and speed variations contribute to a good break-in.

Brakes

WARNING

New brakes will not operate at their maximum efficiency until their break-in is completed. Use extra caution.

Drive Belt

A new drive belt requires a break in period of 50 km (30 mi).

During the break-in period:

- Avoid strong acceleration and deceleration (throttle should not exceed 3/4).
- Avoid pulling a load.
- Avoid high speed cruising.

While reading this Operator's Guide, remember that:

WARNING

Indicates a potential hazard that, if not avoided, could result in serious injury or death.

BASIC PROCEDURES

Starting the Engine

The shift lever must be set to PARK or NEUTRAL.

NOTE: For your convenience, an override mode allows the engine to be started with the shift lever in any position. Press and hold the brake lever(s) or the brake pedal while pressing the engine start button.

Insert key in ignition switch and turn to ON position (570 models) or ensure D.E.S.S. key is installed on D.E.S.S. post (650/850/1000R).

Set the engine stop switch to RUN.

Press the engine start button and hold until the engine starts.

NOTICE If engine does not start after a few seconds, do not hold the engine start button more than 10 seconds. Refer to *TROUBLESHOOTING*.

Release the engine start button immediately when the engine has started.

NOTE: If the battery is dead, engine cannot be started. Have the battery recharged or replaced.

Waking Up the Electrical System

650/850/1000R Models

Press and release the START button for less than half a second and the electrical system will turn ON:

- For 30 seconds, **without** powering any equipment, if the D.E.S.S. key is **NOT** installed on the D.E.S.S. post **OR** if the Engine Stop switch is set to the STOP position;
- For 10 minutes, powering equipment, if the D.E.S.S. key is installed on the D.E.S.S. post **AND** Engine Stop is set to the RUN position. The electrical system will be shut-down after 30 seconds if either the D.E.S.S. key is removed **OR** the Engine Stop is set to the STOP position.

NOTICE Waking up the electrical system repeatedly or using electrical equipment will discharge the battery and you may not be able to start the engine.

Changing Gear Selection

Apply brakes and select the desired shift lever position.

Release brakes.

NOTICE When changing gear selection, always completely stop the vehicle and apply the brakes prior to moving the shift lever. Otherwise, damage to the gearbox may occur.

Gradually press the throttle lever to increase engine speed and thus engaging the continuously variable transmission (CVT).

Stopping the Engine and Parking the Vehicle

WARNING

Avoid parking on slope as the vehicle may roll away.

WARNING

Always put the vehicle in PARK when stopped or parked to prevent rolling.

WARNING

Avoid parking in places where hot parts can start a fire.

When stopped or parked, always bring shift lever to PARK position. This is especially important when parking on a slope. On very steep inclines or if the vehicle is carrying a cargo, the wheels should be blocked using rocks or bricks (or ideally, wheel chocks).

Select the flattest terrain available for parking.

Release throttle and use brakes to completely stop the vehicle.

Set shift lever in PARK position.

Apply the parking brake.

Push the engine stop switch to OFF position.

Turn key in ignition switch to OFF position (570 models) or use the vehicle engine stop switch to stop the vehicle (other models).

Remove key from ignition switch (570 models) or remove D.E.S.S. key from D.E.S.S. post (other models).

SPECIAL PROCEDURES

What to Do if Water Entered the CVT

The CVT drain plug is located on the rear portion of the CVT cover. It is accessible from the rear LH fender.

Inspect the CVT drain plug to validate if water is present.

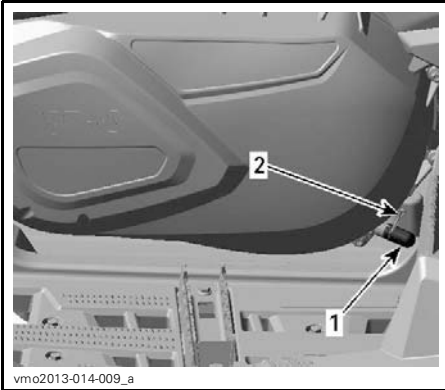

NEAR LH FOOTREST

1. Drain plug
2. Spring clamp

NOTICE If water entered your CVT while in a muddy environment, limit vehicle usage and bring your vehicle to your nearest authorized Can-Am dealer for a proper CVT cleaning procedure.

If water is present, remove CVT drain plug to expel water.

Reinstall the drain plug and secure it using the spring clamp.

NOTE: Make sure drain plug is properly inserted on CVT cover nipple.

NOTICE See an authorized Can-Am dealer to have the CVT inspected and cleaned.

What to Do if Water Entered the Air Filter Housing

Inspect the drain reservoirs in the back of the front left wheel inner fender to validate if water is present.

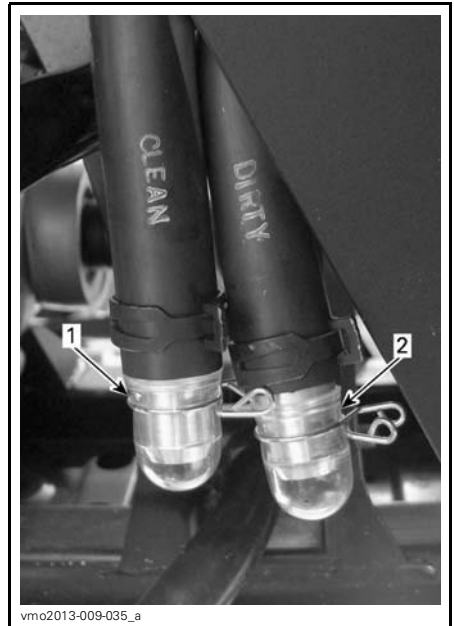

TYPICAL

1. Clean air filter housing drain reservoir
2. Dirty air filter housing drain reservoir

If water is present, press clamps and remove reservoirs to drain water from air filter housing.

If one of the following conditions is met, bring the vehicle to your nearest authorized Can-Am dealer to have the vehicle serviced:

- If more than 50 ml (2 U.S. oz) of water (approximately 5 drain reservoirs) is found in the clean chamber drain hose.
- If any deposits are present in the clean chamber drain reservoir.
- If either hose is obstructed.

In such a case, the vehicle must be serviced for:

- Air filter housing cleaning
- Vents (radiator cooling fan, water pump, coolant reservoir, fuel tank, gearbox, front differential and rear final drive)
- CVT air filter cleaning

- CVT cleaning
- Lubricant inspection and replacement as required (engine, gearbox, front differential and rear final drive).

NOTICE Failure to have vehicle serviced may lead to permanent damage to the following components but not limited to:

- Engine and gearbox
- Fuel pump
- CVT
- Cooling fan
- Front differential
- Rear final drive.

What to Do if Vehicle is Turned Over

When vehicle is turned over or stays tilted on the side, put the vehicle back on its wheels. Inspect vehicle for damages.

⚠ WARNING

Never operate the vehicle if damaged. Refer to an authorized Can-Am dealer.

If vehicle has no damage, refer to *MAINTENANCE PROCEDURES* and inspect the following.

- Inspect air filter housing for oil accumulation, if any oil is found, clean air filter and air filter housing.
- Check engine oil level and refill if necessary.
- Check engine coolant level and refill if necessary.
- Check gearbox oil level and refill if necessary.
- Check rear final drive oil level and refill if necessary.
- Check front differential level and refill if necessary.
- Start engine. If the oil pressure light stays on, stop engine immediately. See an authorized Can-Am dealer.

Whenever the vehicle is turned over, it should be inspected by an authorized Can-Am dealer.

NOTICE When reinstalling the gauge support, ensure that all vent hoses are routed properly close to the air duct.

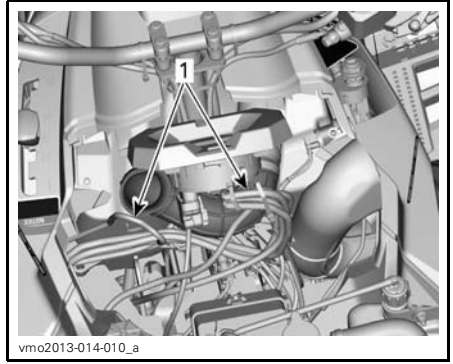

TYPICAL - GAUGE SUPPORT REMOVED FOR CLARITY - 570, 650 AND 850 MODELS

1. Route vent hoses close to air duct

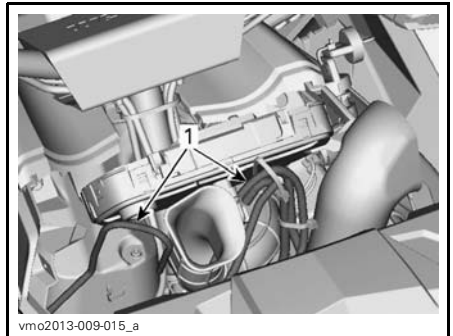

GAUGE SUPPORT REMOVED FOR CLARITY - 1000R MODEL

1. Route vent hoses close to air duct

What to Do if Vehicle is Immersed in Water

Should the vehicle become immersed, immediately stop the engine. Do not use:

- Any electrical equipments
- Winch.

It will be necessary to take the vehicle to an authorized Can-Am dealer as soon as possible. **NEVER ATTEMPT TO START THE ENGINE!**

NOTICE Immersion of the vehicle can cause serious damage if the correct restart procedure is not followed.

As soon as vehicle is pulled out of water, carry out the following:

- Drain air filter housing. Refer to *WHAT TO DO IF WATER ENTERED THE AIR FILTER HOUSING* in this section.
- Drain CVT. Refer to *WHAT TO DO IF WATER ENTERED THE CVT* in this section.

NOTICE The vehicle should be serviced as soon as possible by an authorized Can-Am dealer.

TUNE YOUR RIDE

⚠ WARNING

Suspension adjustment could affect vehicle handling. Always take time to familiarize yourself with the vehicle's behavior after any suspension adjustment have been made.

Following are guidelines to fine-tune suspension.

For your convenience, a suspension adjustment tool is provided in the tool kit.

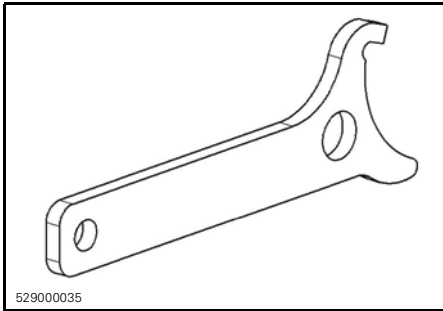

529000035

SUSPENSION ADJUSTMENT TOOL

Suspension Adjustment

Suspension adjustment and loading can have an effect on your vehicle handling and comfort.

Choice of suspension adjustments vary with driver's weight, personal preference, riding speed and field condition.

NOTE: Factory settings are suitable for almost all conditions. Take into consideration that an increase in ground clearance can affect the handling of the vehicle.

FRONT SUSPENSION FACTORY PRELOAD SETTINGS		
ADJUSTMENT	MODEL	FACTORY SETTING
Spring preload	570 and 650	Cam position 3
	850 and 1000R	64.6 mm

REAR SUSPENSION FACTORY PRELOAD SETTINGS		
ADJUSTMENT	MODEL	FACTORY SETTING
Spring preload	570 and 650	Cam position 3
	850 and 1000R	152.1 mm

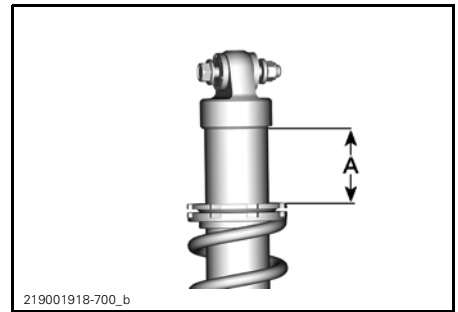

219001918-700_b

TYPICAL

A = 64.6 mm (2.543 in) (Front of 850)

A = 159.8 mm (6.291 in) (Rear of 850)

A = 60.6 mm (2.386 in) (Front of 1000R)

A = 148.2 mm (5.835 in) (Rear of 1000R)

While reading this Operator's Guide, remember that:

⚠ WARNING

Indicates a potential hazard that, if not avoided, could result in serious injury or death.

Spring Preload Adjustment

⚠ WARNING

The left and right shock adjustment on front or rear suspension must always be set to the same position. Never adjust one only. Uneven adjustment can cause poor handling and loss of stability, which could lead to an accident.

Shorten the springs for a firmer ride and rough conditions.

Lengthen the springs for a softer ride and smooth conditions.

Adjust spring preload by turning the adjuster ring.

NOTE: Do not increase preload on FOX shocks.

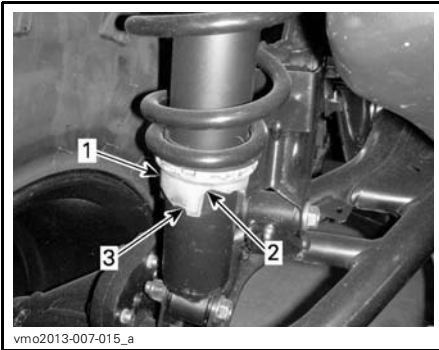

TYPICAL 650

1. Adjustment cam
2. Softer adjustment
3. Firmer adjustment

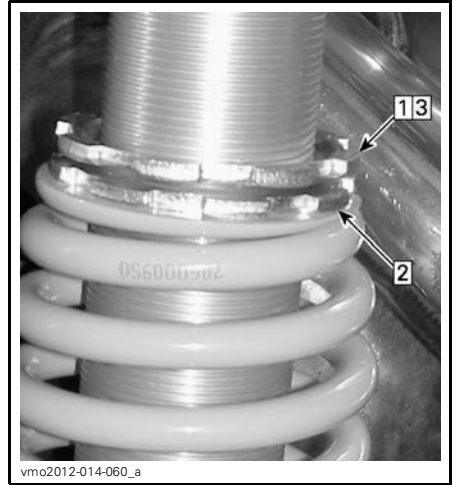

TYPICAL 850 AND 1000R

- Step 1: Loosen top locking ring
- Step 2: Turn adjusting ring accordingly
- Step 3: Tighten top locking ring

Dynamic Power Steering (DPS) Assist Level Adjustment

The Dynamic Power Steering (DPS) offers easy steering assistance to the rider. The level of assistance will automatically adapt according to the vehicle's speed and rider's preferences, in order to provide maximum steering power at lower speed where the demand is normally higher. As speed increases, the assistance is progressively reduced to keep maximum steering feel and precision to the rider.

Three settings are available.

AVAILABLE DPS SETTINGS	
DPS MAX.	Maximum steering assist
DPS MED.	Medium steering assist
DPS MIN.	Minimum steering assist

NOTE: As per options or installed accessories, it is possible that a special setting may be activated automatically.

Models equipped with a Visco-4Lock front differential

When the 4WDLock mode is selected, a special setting is automatically selected to give an optimal assist.

It is not possible to change the DPS setting while the 4WDLock mode is selected.

Active DPS Setting

To show the active DPS mode, proceed as follows:

1. Press and release **Override/DPS** button.

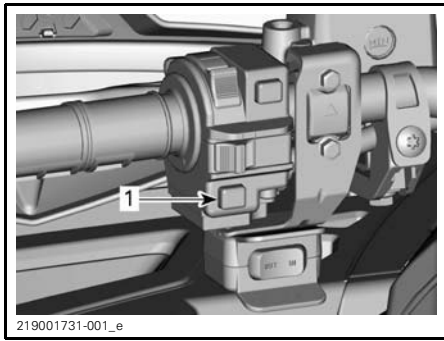

1. **Override/DPS** button

2. Check the multifunction gauge to confirm the active DPS mode.

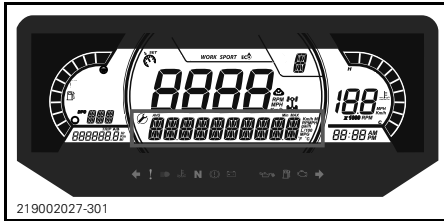

219002027-301

Changing DPS Setting

To change the DPS mode, proceed as follows:

1. Press and hold **Override/DPS** button for 2 seconds to go to the next setting.
2. Release **Override/DPS** button.

3. Repeat until desired setting is selected.

Models equipped with a 570 or a 650 engines that are not NRMM compliant

The DPS adjustment will not be possible by **Override/DPS** button if the vehicle is not running.

You can access using the cluster:

1. Hold **LOWER (MENU)** button for 1 second to change the DPS Mode.
2. Repeat until desired setting is selected.

Perequisites

1. Start the engine.
2. Place the shift lever in a position other than the Reverse.

Changing Setting

1. Press and hold **Override/DPS** button for 2 seconds to go to the next setting.
2. Release **Override/DPS** button.
3. Repeat until desired setting is selected.

TRANSPORTING THE VEHICLE

When contacting a towing or transporting service, be sure to ask if they have a flatbed trailer, loading ramp or power ramp to safely lift the vehicle and tie-down straps. Ensure the vehicle is properly transported as specified in this section.

NOTICE Do not tow this vehicle — towing can seriously damage the vehicle's drive system.

NOTICE Avoid using chains to tie the vehicle — they may damage the surface finish or plastic components.

⚠ WARNING
Make sure no loose objects are present inside vehicle during vehicle transportation.

⚠ WARNING
Always transport the vehicle facing forward to avoid damaging the windshield or other components. Parts may detach during transport.

⚠ WARNING
Before attempting to mount vehicle onto a platform or a trailer, make sure to respect the following safety precautions.

SAFETY PRECAUTIONS	
Carrying equipment	The carrying item (platform or trailer or flat bed) must be of appropriate dimensions and capacity to safely support and transport the vehicle.
Hauling vehicle	Do not exceed vehicle hauling capacity and specifications. Ensure the trailer or platform is properly secured to the hauling vehicle hitch.
Visibility	Ensure you have a good visibility during the entire maneuver.
Terrain	The hauling vehicle and trailer must be on a leveled surface. Use wheel chocks on trailer and hauling vehicle to avoid any movement.
Ramps	Use ramps with proper rating and secure ramps to the trailer or platform. Avoid steep ramps.
Bystanders	Always make sure bystanders are not close to the vehicle or the trailering equipment while climbing up.

Using Vehicle Power to Climb onto Trailering Equipment

When vehicle can climb on its own power, proceed as follows;

Wear protective gear.

While reading this Operator's Guide, remember that:

⚠ WARNING
Indicates a potential hazard that, if not avoided, could result in serious injury or death.

Use low gear only (if equipped).

If vehicle has 4wd (or 6wd) option, use it.

When driving remain seated at all times.

Ensure proper alignment on rails or platform.

1. Start from a sufficient distance from the trailer to align the vehicle in a straight line with the ramps. Never attempt to turn while getting closer to the ramp. Rear wheels might not be aligned once you get to the ramp and vehicle may fall off.
2. Slowly climb the front wheels onto the ramp to verify alignment.
3. Back off the vehicle, verify ramps are still secure, then proceed at proper speed.
4. Carefully drive vehicle onto platform or trailer. Use sufficient speed to climb without spinning or abruptly accelerating. Avoid acceleration while on ramps to prevent ramps movement.
5. If trailer is inclined towards front, simply let vehicle roll in without acceleration.
6. Once vehicle is climbed, put shift lever to Park. Apply parking brake.

When vehicle cannot move on its own power, or in case overshooting is a risk or if any dangerous condition prevents for embarking on its own power, proceed using a winch;

Using a Winch to Pull Vehicle onto Trailering Equipment

When vehicle cannot climb on its own power, proceed as follows;

WARNING

Have the help of an assistant. One person should be in vehicle to have access to vehicle steering, brakes and winch switch, while the other person controls the environment and safety of the maneuver.

WARNING

Ensure the winch hook can be safely attached to a proper anchoring point. Use proper rigging.

NOTE: If vehicle can be started safely, let engine idle during winching to avoid draining the battery.

1. Place shift lever to NEUTRAL (N).
2. If the vehicle is equipped with a winch, use the winch to roll the vehicle on the platform.
3. If the vehicle is not equipped with a winch, proceed as follows:
 - 3.1 Attach strap to lower front bumper anchor.
 - 3.2 Attach the strap to the winch cable of the towing vehicle.
 - 3.3 Pull the vehicle on the flatbed trailer with the winch.
4. Put shift lever to Park. Apply parking brake.

Securing vehicle for transport

When transporting this vehicle, secure it to a trailer or in pickup box with suitable tie-downs. Use of ordinary ropes is not recommended.

⚠ WARNING

Do not tow this vehicle behind a car or other vehicle. Use a trailer. Never tip this vehicle on end for transporting. The vehicle must be in its normal operating position (on all wheels).

Remember to:

- Unload vehicle racks before transportation.
- Set shift lever to PARK position.
- Set the parking brake.
- Secure the vehicle by the front and rear tie-down points.



vmo2013-007-014_a

TYPICAL

1. Front tie-down point location

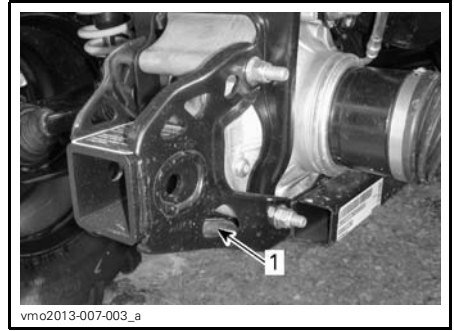

vmo2013-007-003_a

TYPICAL

1. Rear tie-down point location

NOTICE Securing vehicle at other locations may damage the vehicle.

Getting vehicle out of trailer

⚠ WARNING

Vehicle may have moved during transport. Ensure vehicle is properly aligned with ramps before proceeding.

⚠ WARNING

Visibility will be greatly reduced when backing off from the trailer. Have the help of an assistant to ensure proper alignment and safe environment.

MAINTENANCE

MAINTENANCE SCHEDULE

Maintenance is very important for keeping your vehicle in safe operating condition. The vehicle should be serviced as per the maintenance schedule.

The maintenance schedule does not exempt the pre-ride inspection or post operation care.

WARNING

Failure to properly maintain the vehicle according to the maintenance schedule and procedures can make it unsafe to operate.

EPA Regulation - Canadian and USA Vehicles

A repair shop or person of the owner's choosing may maintain, replace, or repair emission control devices and systems. These instructions do not require components or service by BRP or authorized Can-Am Off-Road dealers.

Although an authorized Can-Am Off-Road dealer has an in-depth technical knowledge and tools to service your vehicle, the emission-related warranty is not conditioned on the use of an authorized Can-Am Off-Road dealer or any other establishment with which BRP has a commercial relationship.

Proper maintenance is the owner's responsibility. A warranty claim may be denied if, among other things, the owner or operator caused the problem through improper maintenance or use.

For emission-related warranty claims, BRP is limiting the diagnosis and repair of emission-related parts to the authorized Can-Am Off-Road dealers. For more information, please refer to the *US EPA EMISSION-RELATED WARRANTY* contained in the *WARRANTY* section.

You must follow the instructions for fuel requirements in the fueling section of this manual. Even if gasoline containing greater than ten volume percent ethanol is readily available, the US EPA issued a prohibition against the use of gasoline containing greater than 10 vol% ethanol that applies to this vehicle. The use of gasoline containing greater than 10 vol% ethanol with this engine may harm the emission control system.

The maintenance schedule does not exempt the pre-ride inspection.

Follow the appropriate maintenance intervals according to the environment where the vehicle is used: normal environment or extreme environment (mud, water, dust).

POST OPERATION CARE AFTER EACH USE IN AN EXTREME ENVIRONMENT

Rinse the vehicle and its components with fresh water

Clean the CVT air filter (refer to *MAINTENANCE PROCEDURES*)

Drain the CVT compartment (and clean if any water or mud is found)

While reading this Operator's Guide, remember that:

WARNING

Indicates a potential hazard that, if not avoided, could result in serious injury or death.

POST OPERATION CARE AFTER EACH USE IN AN EXTREME ENVIRONMENT
Inspect and clean engine air filter. Clean if any water or mud is found (refer to <i>MAINTENANCE PROCEDURES</i>)
Inspect and drain the air filter housing (and clean if any water or mud is found) (refer to <i>MAINTENANCE PROCEDURES</i>)
Clean radiator (refer to <i>MAINTENANCE PROCEDURES</i>)
Visually inspect for any water accumulation in the vent hoses (fuel tank, gearbox, front differential and rear final drive). If there is water, bring the vehicle to your nearest authorized Can-Am dealer for inspection and servicing of main components related to the vents
Carefully clean front and rear shock absorbers to prevent seal damage from dust or dirt

SEVERE DUSTY CONDITIONS

Engine Air Filter Maintenance Guideline

Air filter maintenance should be adjusted according to riding conditions.

Air filter maintenance must be increased in frequency in the following dusty conditions:

- Riding on dry sand
- Riding on dry dirt covered surfaces
- Riding on dry gravel roads or similar conditions.

NOTE: Riding in a group in these conditions would increase even more the air filter maintenance.

MAINTENANCE SCHEDULE LEGEND

Operation in severe riding conditions (dusty or muddy) or carrying heavy loads condition
Operation in trail riding conditions

MAINTENANCE SCHEDULE

Make sure to perform proper maintenance at recommended intervals as indicated in the tables. Some items of the maintenance schedule must be performed in function of the calendar, regardless of the distance or time of operation.

EVERY 750 KM (500 MI) OR 25 HOURS (whichever comes first)
EVERY 1 500 km (1,000 mi) OR 50 HOURS (whichever comes first)
Verify and clean engine air filter. Replace as needed
Verify battery connections
Inspect front differential and rear final drive oil level and look for contamination. Replace if necessary
Lubricate rear propeller shaft joints

EVERY 750 KM (500 MI) OR 25 HOURS (whichever comes first)

EVERY 1 500 km (1,000 mi) OR 50 HOURS (whichever comes first)

Inspect tie rod ends and ball joints for play and boots condition

Lubricate front suspension arm bushings

Lubricate front and rear stabilizer bar bushings

Inspect the drive shaft boots and protectors

Inspect brake pads. Replace as needed

Inspect wheel bearings for abnormal play

Verify gearbox oil level and look for contamination

Inspect and clean CVT air filter. Replace as needed. (If equipped)

Lubricate upper shock absorber spherical bearings (Outlander X mr 1000R)

EVERY 1 500 KM (1,000 MI) OR 50 HOURS (whichever comes first)

EVERY 3 000 km (2,000 mi) OR 100 HOURS (whichever comes first)

Adjust valve clearance

Clean muffler spark arrester

Verify and clean throttle body

Replace fuel vent breather filter

Verify CVT drive belt and clean CVT pulleys

Lubricate the one way bearing of the drive pulley

The following must be performed at least once a year:

Change engine oil and filter

Lubricate throttle cable

Inspect and clean brake system

Inspect battery condition

Verify steering system for abnormal play

Verify front differential and rear final drive oil level and look for contamination

Verify gearbox oil level and look for contamination

**PERFORM AT THE FIRST 1 500 KM (1,000 MI) AND AT 3 000 KM (2,000 MI)
THEN FOLLOW THE REGULAR SCHEDULE**

**PERFORM AT THE FIRST 3 000 km (2,000 mi) AND AT 6 000 km (4,000 mi)
THEN FOLLOW THE REGULAR SCHEDULE**

Replace gearbox oil

Clean the vehicle speed sensor (VSS)

EVERY 3 000 KM (2,000 MI) OR 100 HOURS (whichever comes first)

EVERY 6 000 km (4,000 mi) OR 200 HOURS (whichever comes first)

Verify the cooling system

Test engine coolant strength

Verify fuel system for leaks

Verify fuel pump pressure

Replace spark plugs

Replace front differential oil

Replace rear final drive oil

Replace gearbox oil

Inspect input and output shaft seals (gearbox, differential and final drive)

Clean vehicle speed sensor

Clean and lubricate lower and upper steering column half bushings

The following must be performed every 2 years:

Replace the brake fluid

EVERY 6 000 KM (4,000 MI) OR 5 YEARS (whichever comes first)

EVERY 12 000 km (8,000 mi) OR 5 YEARS (whichever comes first)

Replace engine coolant

MAINTENANCE PROCEDURES

This section includes instructions for basic maintenance procedures.

⚠ WARNING

Turn off the engine and follow these maintenance procedures when performing maintenance. If you do not follow proper maintenance procedures you can be injured by hot parts, moving parts, electricity, chemicals or other hazards.

⚠ WARNING

Should removal of a locking device be required (e.g. lock tab, self-locking fastener, etc.), always replace it with a new one.

Air Filter

Air Filter Maintenance Guideline

As with any ATV, air filter maintenance is critical to ensure proper engine performance and life span.

Air filter maintenance should be adjusted according to riding conditions.

Air filter maintenance must be increased in frequency and oil must be added to the foam filter element for the following dusty conditions:

- Riding on dry sand
- Riding on dry dirt covered surfaces
- Riding on dry gravel roads or similar conditions.

NOTE: Riding in a group in these conditions would increase even more the air filter maintenance. Refer to *AIR FILTER CLEANING AND OILING* in this section for maintenance procedure.

While reading this Operator's Guide, remember that:

⚠ WARNING

Indicates a potential hazard that, if not avoided, could result in serious injury or death.

NOTE: An accessory pre-filter for "dusty conditions" may be used. Contact an authorized Can-Am dealer for details.

Air Filter Removal

NOTICE Never remove or modify any component in the air filter housing. Otherwise, engine performance degradation or damage can occur. The engine is calibrated to operate specifically with these components.

Remove seat.

Remove console.

Lift rear portion of console upwards until the studs are released from the grommets.

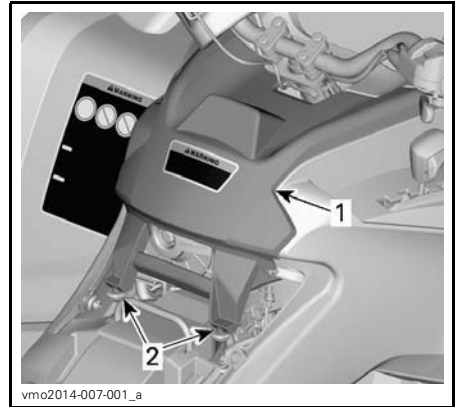

TYPICAL

1. Console
2. Studs and grommets

Pull console rearwards.

Rotate air filter cover counterclockwise to remove.



1. Air filter cover

Remove air filter.



AIR FILTER REMOVAL

Air Filter Cleaning and Oiling

⚠ CAUTION Always wear appropriate skin and eye protection. Chemicals can cause a skin rash and eye injury.

Paper Filter Cleaning

1. Remove the foam filter from paper filter.
2. Tap out heavy dust from the paper element.

This will allow dirt and dust to get out of the paper filter.

NOTE: Paper filter have a limited life span; replace filter if too dirty or clogged.

NOTICE It is not recommended to blow compressed air on the paper filter; this could damage the paper fibers and reduce its filtration ability when used in dusty environments.

NOTICE Do not wash the paper filter with any cleaning solution.

Foam Filter Element Cleaning

1. Spray the foam filter element inside and out with a good air filter cleaner and follow manufacturer's instructions.



TYPICAL - SPRAY THE FOAM FILTER

2. Dry the foam element completely.

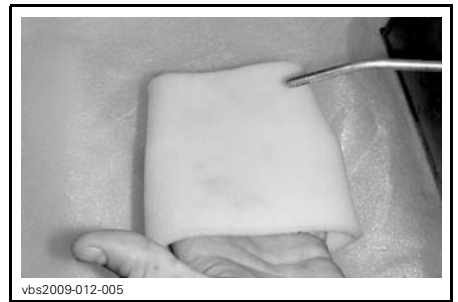

TYPICAL - DRY

NOTE: A second application may be necessary for heavily soiled elements.

Foam Filter Element Lubrication

1. Make sure foam filter is clean and dried. Refer to *FOAM FILTER CLEANING*.
2. Lubricate the foam filter element.

SERVICE PRODUCT

AIR FILTER OIL (P/N 219 700 340)



vbs2009-012-014

3. Let stand for 3 to 5 minutes.
4. Remove any excess of oil that could transfer to the paper filter by wrapping the foam filter element into an absorbent cloth and squeezing gently. This will also ensure a full oil coverage on foam filter.
5. Reinstall the foam filter element over the paper filter.

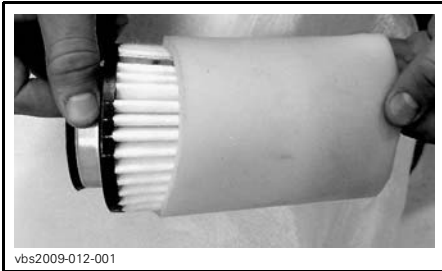

vbs2009-012-001

TYPICAL

Air Filter Installation

Reinstall oiled foam filter on paper air filter.

Slightly grease O-ring seal and plastic body of air filter.

Install air filter as the reverse of removal.

Ensure air filter cover is properly locked onto the air filter housing. See indications on filter cover and housing.

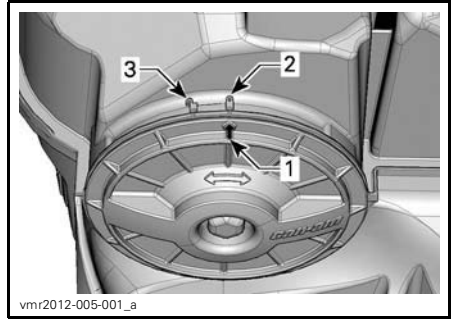

vmr2012-005-001_a

TYPICAL

1. Cover position arrow
2. Locked
3. Unlocked

Install console as the reverse of removal. However, pay attention to the following.

Align console front tabs with slots, then push console forward.

Then align and insert studs with grommets on rear portion of console until studs engage with grommets.

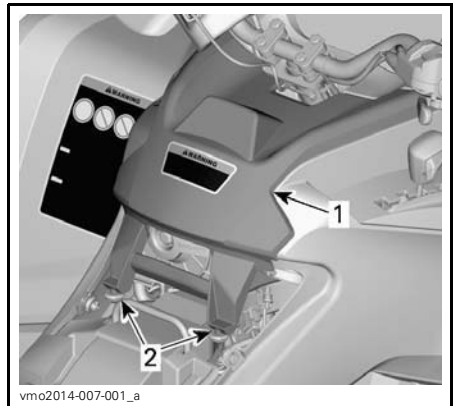

vmo2014-007-001_a

TYPICAL

1. Console
2. Studs and grommets

Reinstall the seat.

Engine Oil

Engine Oil Level

NOTICE Check level frequently and refill if necessary. **Do not overfill.** Operating the engine/gearbox with an improper level may severely damage engine/gearbox. Wipe off any spillage.

NOTE: While checking the oil level, visually inspect engine area for leaks.

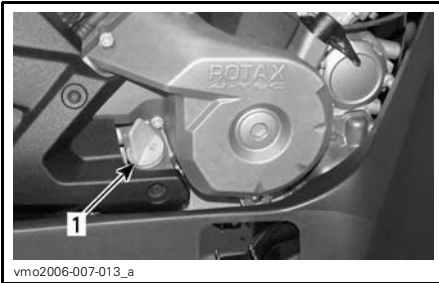

RH SIDE OF ENGINE

1. Dipstick

With vehicle on a level surface and engine cold, not running, check the oil level as follows:

1. Unscrew dipstick then remove it and wipe clean.
2. Reinstall dipstick, screw in it completely.
3. Remove and check oil level. It should be near or equal to the upper mark.

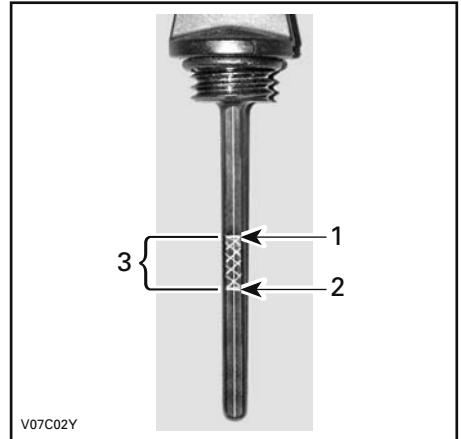

TYPICAL

1. Full
2. Add
3. Operating range

To add oil, remove dipstick. Place a funnel into the dipstick tube to avoid spillage.

Add a small amount of recommended oil and recheck oil level.

Repeat the above procedures until oil level reaches the dipstick's upper mark. **Do not overfill.**

Properly tighten dipstick.

Recommended Engine Oil

Rotax® engines were developed and validated using the XPS™ oil. BRP recommends the use of its XPS engine oil or an equivalent at all time. Damages caused by the use of an oil not suitable for the engine may not be covered by the BRP Limited Warranty.

XPS RECOMMENDED ENGINE OIL	
General purpose	4T 5W40 Synthetic blend oil
Cold temperature	4T 0W40 Synthetic oil

XPS RECOMMENDED ENGINE OIL	
Warm temperature	4T 10W50 Synthetic oil
IF THE RECOMMENDED XPS ENGINE OIL IS NOT AVAILABLE	
<p>Use a 4-stroke SAE engine oil meeting or exceeding the following lubricant industry specifications. Always check the API service label certification on the oil container, it must contain at least one of the indicated standards.</p> <ul style="list-style-type: none"> – API service classification SJ, SL, SM or SN 	

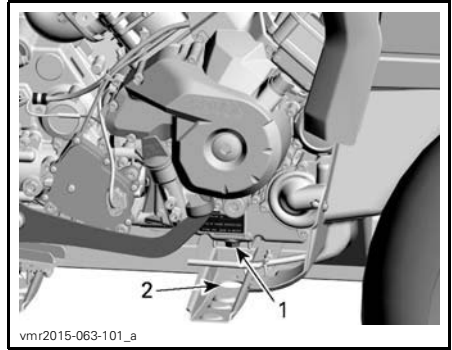

TYPICAL - 570 MODEL SOME PARTS REMOVED FOR CLARITY

1. Drain plug
2. Access through frame

Engine Oil Change

⚠ CAUTION The engine oil can be very hot. Wait until engine oil is warm.

Oil and filter are to be replaced at the same time.

Bring engine to its normal operating temperature.

Ensure vehicle is on a level surface.

Remove dipstick.

Clean the oil drain plug area.

Place a drain pan under the oil drain plug area.

Unscrew oil drain plug.

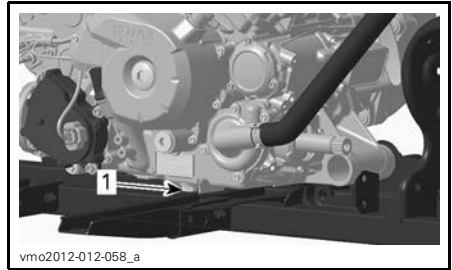

TYPICAL - 650 AND 850 MODELS SOME PARTS REMOVED FOR CLARITY

1. Oil drain plug

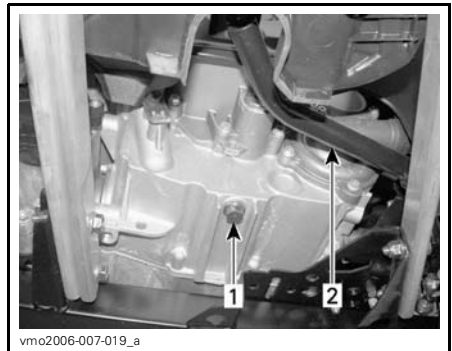

TYPICAL - 1000R MODEL

1. Oil drain plug
2. Brake pedal

Allow enough time for oil to flow out of oil filter.

Replace the oil filter. Refer to *OIL FILTER* in this section.

Change gasket on oil drain plug.
 Clean gasket area on engine and oil drain plug then reinstall plug.
 Refill engine at the proper level with the recommended oil.
 Refer to *SPECIFICATIONS* section for oil capacity.
 Start engine and let idle for a few minutes.
 Ensure oil filter area and oil drain plug areas are not leaking.
 Stop engine.
 Wait a while to allow oil to flow down to crankcase then check oil level.
 Refill as necessary.
 Dispose of oil as per your local environmental regulations.

Oil Filter

Oil Filter Replacement

Remove the right engine cover.
 Unscrew the oil filter cover.



1. Oil filter cover

Remove the oil filter and replace with a new filter.
 Install a **NEW** O-ring on oil filter cover.
 Apply engine oil on O-ring and on end of filter.
 Install the new filter into the cover.
 Screw oil filter cover in place.

Tighten oil filter cover screws to recommended specification.

TIGHTENING TORQUE	
Oil filter cover screws	10 N•m ± 1 N•m (89 lbf•in ± 9 lbf•in)

Wipe out any oil spillage on engine.

Radiator

Radiator Inspection and Cleaning

Periodically check the radiator area for cleanliness.

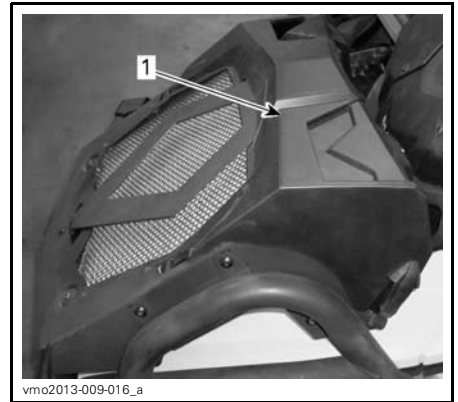

TYPICAL

1. Radiator

Inspect radiator and hoses for leaks or any damage.

To access the hoses and the engine coolant reservoir, remove the radiator cover. Refer to *EQUIPMENT* section.

Inspect radiating fins. They must be clean, free of mud, dirt, leaves and any other deposit that would prevent the radiator to cool properly.

To access the radiating fins, remove the radiator protector.

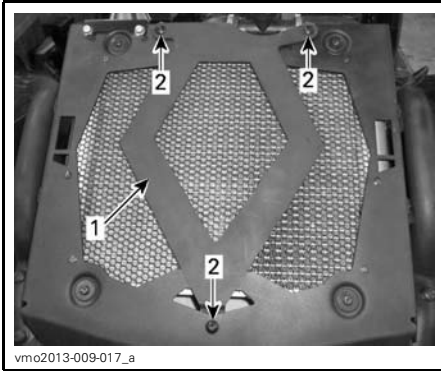

1. Diamond-shaped plate
2. Retaining screws

Remove as much deposits as you can with your hands. If water is available in proximity, try rinsing the radiating fins.

If available, use a garden hose to rinse the radiating fins.

CAUTION Never clean radiator with your hands when it is hot. Let the radiator cool down before cleaning.

NOTICE Be careful not to damage the radiating fins when cleaning. Do not use any object/tool that could damage the fins. The fins are purposely thin parts to allow efficient cooling. **WHEN HOSING, USE LOW PRESSURE ONLY, NEVER USE A HIGH PRESSURE WASHER.**

See an authorized Can-Am dealer, repair shop or person of your own choosing to check the performance of the cooling system.

Engine Coolant

Engine Coolant Level Verification

WARNING

Check coolant level with engine cold. Never add coolant in cooling system when engine is hot.

1. Remove the radiator cover. Refer to *EQUIPMENTS* section.
2. With vehicle on a level surface, liquid should be between MIN. and MAX. level marks of coolant reservoir.

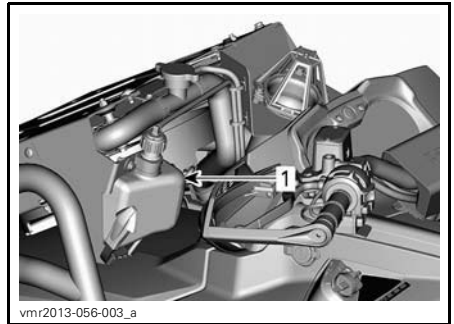

1. Engine coolant reservoir

NOTE: When checking level at temperature lower than 20°C (68°F), it may be slightly lower than MIN. mark.

NOTE: Ensure coolant reservoir hose is properly routed to avoid any interference when closing cover.

If coolant is added in the coolant reservoir, check also the level in the radiator.

WARNING

In order to avoid potential burning, do not remove the radiator cap if the engine is hot.

NOTE: A cooling system that frequently requires coolant is the indication of leaks or engine problems. See an authorized Can-Am dealer.

Adding Coolant

1. Remove the coolant reservoir cap.
- NOTE:** Take note of the vent routing.
2. Add coolant up to Max mark. Do not overfill.
- NOTE:** Use a funnel to avoid spillage.
3. Properly reinstall and tighten coolant reservoir cap.

NOTICE Do not store any objects in the front service compartment.

4. Reinstall the radiator cover.



TYPICAL
1. Radiator cap

Recommended Engine Coolant

XPS RECOMMENDED ENGINE COOLANT
Extended life pre-mixed coolant
IF THE RECOMMENDED XPS ENGINE COOLANT IS NOT AVAILABLE
Use distilled water and antifreeze solution specifically designed for aluminum engines (50% distilled water, 50% antifreeze)

NOTICE Always use ethylene-glycol antifreeze containing corrosion inhibitors specifically for internal combustion aluminum engines.

Unscrew the coolant drain plug on the water pump and drain the coolant into a suitable container.

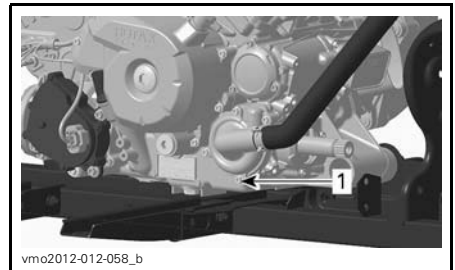

TYPICAL - 570, 650 AND 850 MODELS
1. Coolant drain plug

Engine Coolant Replacement

⚠ WARNING

In order to avoid potential burns, do not remove the radiator cap or loosen the coolant drain plug if the engine is hot.

NOTICE Do not store any objects in the front service compartment.

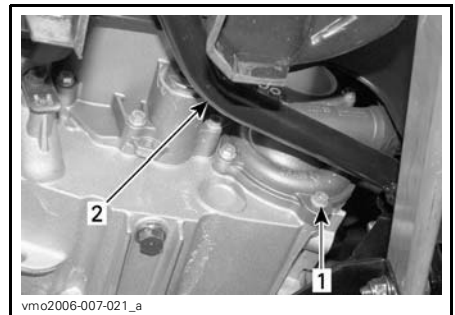

TYPICAL - 1000R MODEL
1. Coolant drain plug
2. Brake pedal

Remove the radiator cap by applying pressure and turning it counterclockwise.

NOTE: Do not unscrew the coolant drain plug completely.

Remove the RH side panel.

Unscrew the bleeding screw on the top of thermostat housing.

NOTE: To access the bleeding screw, remove the CVT filter outlet.



1. Bleeding screw

Drain the system completely.

Reinstall the coolant drain plug. Tighten to specification.

TIGHTENING TORQUE	
Drain plug	9 N•m to 11 N•m (80 lbf•in to 97 lbf•in)

Fill the radiator until the coolant comes out by the thermostat housing hole.

Install the bleeding screw.

Complete the radiator filling.

Check the level in the coolant reservoir and refill if necessary.

Run engine at idle with the radiator cap off. Slowly add coolant if necessary.

At this point, wait until engine reaches normal operating temperature.

Depress the throttle lever two or three times; then add coolant if required.

Install radiator cap as the reverse of removal.

Inspect all connections for leaks and check coolant level in the reservoir.

Muffler Spark Arrester

Muffler Spark Arrester (570 Models)

The muffler must be periodically purged of accumulated carbon.

Select a well-ventilated area and make sure the muffler is cool.

⚠ WARNING

Never run engine in an enclosed area. Never perform this operation immediately after the engine has been run because exhaust system is very hot. Make sure that there are no combustible materials in the area. Wear eye protection and gloves. Never stand behind the vehicle while purging exhaust system. Respect all applicable laws and regulations.

Place shift lever in PARK.

Stop engine and let muffler cool down.

Remove the cleanout plug of the muffler.

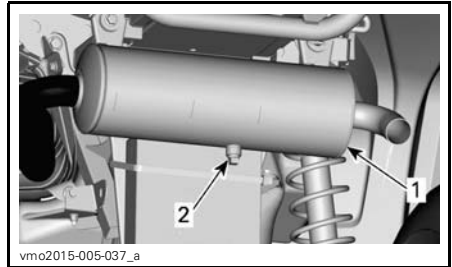

TYPICAL
1. Muffler
2. Cleanout plug

Start engine.

Momentarily increase engine RPM several times to purge accumulated carbon out of the muffler.

Stop engine and let muffler cool down.

Reinstall the clean out plug.

Muffler Spark Arrester Cleaning and Inspection (650, 850 and 1000R Models)

CAUTION Let exhaust system cool down before proceeding with cleaning and inspection.

Remove the muffler cover. Discard retaining screws.

NOTICE Do not use impact tool for any screw removal.

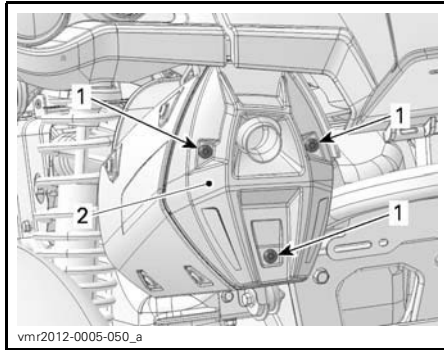

1. Muffler cover
2. Retaining screw

Remove and discard the tail pipe retaining screws.

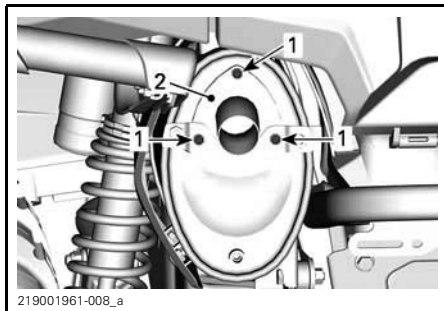

- TYPICAL**
1. Screws
 2. Tail pipe

Remove exhaust tail pipe, gasket (discard) and spark arrester.

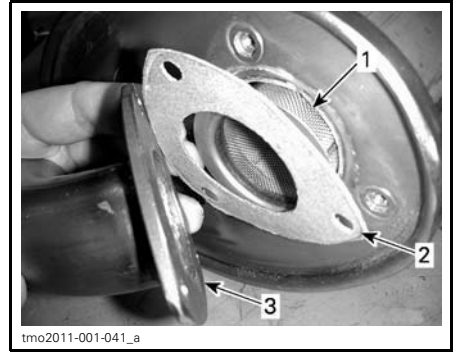

- TYPICAL**
1. Spark arrester
 2. Gasket
 3. Exhaust tail pipe

Remove carbon deposits from the spark arrester using a brush.

NOTICE Use a soft brush and be careful to avoid damaging spark arrester mesh.

CAUTION Wear eye protection and gloves.



1. Clean spark arrester

Inspect mesh of spark arrester for any damage. Replace as required.

NOTE: Spark arrester screen replacement is required only when damaged

Inspect spark arrester chamber in muffler. Clean any debris as required.

Install new gasket, tail pipe and new retaining screws.

Reinstall muffler cover with new retaining screws. Tighten to specification.

TIGHTENING TORQUE	
Tail pipe screws	11 N•m ± 1 N•m (97 lbf•in ± 9 lbf•in)
Cover screws	

CVT Air Filter

CVT Air Filter Removal

1. Remove the radiator cover. Refer to *EQUIPMENT* section.
2. Remove the CVT air filter by removing the three screws and pressing on the tabs.

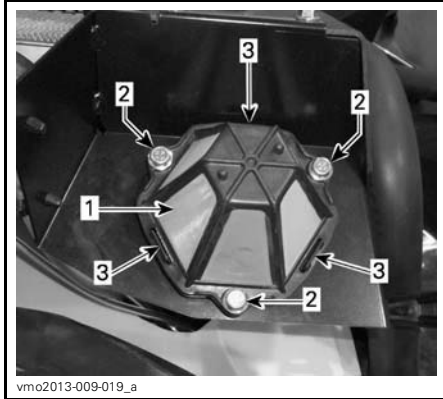

1. CVT air filter
2. Screws
3. Tabs

CVT Air Filter Cleaning

1. Spray filter inside and out with a good air filter cleaner and follow manufacturer's instructions.
2. Dry filter completely.



1. CVT air filter

CVT Air Filter Installation

1. Carefully push the CVT air filter until the three tabs click.
2. Secure using the screws. Tighten to specified torque.

TIGHTENING TORQUE	
CVT air filter screws	2.5 N•m ± 0.5 N•m (22 lbf•in ± 4 lbf•in)

3. Reinstall the radiator cover.

Gearbox Oil

Gearbox Oil Level Verification

NOTICE Check level and refill if necessary. **Do not overfill.** Operating the gearbox with an improper level may severely damage gearbox. Wipe off any spillage.

Place the vehicle on a level surface.

Select NEUTRAL position.

Apply parking brake.

NOTE: Check the gearbox oil level when engine is cold and not running.

Remove the gearbox oil level plug.

While reading this Operator's Guide, remember that:

WARNING

Indicates a potential hazard that, if not avoided, could result in serious injury or death.

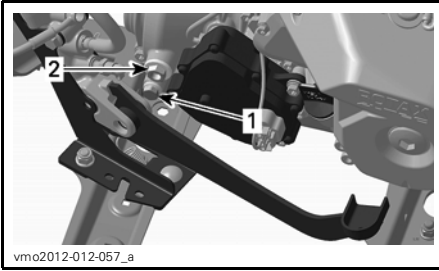

1. Drain plug
2. Oil level plug

The oil should be level with the bottom of the oil level hole.

Refill as required until gearbox oil level flows through oil level hole.

Recommended Gearbox Oil

XPS RECOMMENDED GEARBOX OIL
75W140 Synthetic gear oil
IF THE RECOMMENDED XPS GEARBOX OIL IS NOT AVAILABLE
Use 75W 140 API GL-5 synthetic gear oil

NOTE: The XPS oil is specially formulated to meet the lubrication requirements of this gearbox. BRP strongly recommends the use of its XPS oil.

NOTICE Do not use another types of oil when servicing. Do not mix with other types of oil.

Gearbox Oil Change

Place the vehicle on a level surface.

Clean the drain plug area.

Clean the oil level plug area.

Place a drain pan underneath the drain plug.

Remove the drain plug.

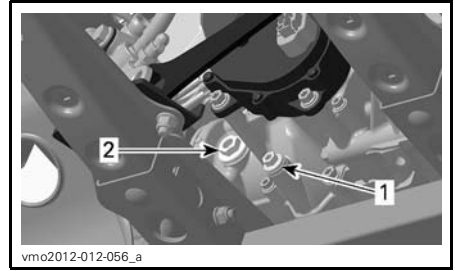

- TYPICAL**
1. Drain plug
 2. Oil level plug

NOTE: To completely drain the gearbox, place a jack under the left footrest and tilt the vehicle toward the right side. When the gearbox is empty, install the drain plug and replace the vehicle on the ground.

Clean the drain plug from any metallic particles.

Install the drain plug.

TIGHTENING TORQUE	
Drain plug	20 N•m ± 2 N•m (15 lbf•ft ± 1 lbf•ft)

Refill gearbox with recommended oil.

NOTICE Do not use another types of oil when servicing. Do not mix with other types of oil.

The oil should be level with the bottom of the oil level hole.

Refill as required until gearbox oil level flows through oil level hole.

NOTICE Do not overfill.

Reinstall oil level plug.

TIGHTENING TORQUE	
Oil level plug	5 N•m ± 0.6 N•m (44 lbf•in ± 5 lbf•in)

Throttle Cable

Throttle Cable Lubrication (If applicable)

The throttle cable must be lubricated with a silicone based lubricant or an equivalent.

⚠ WARNING

Always use a silicone-based lubricant. Using another lubricant (like a water-based lubricant) could cause the throttle lever/cable to become sticky and stiff.

Open the throttle lever housing.

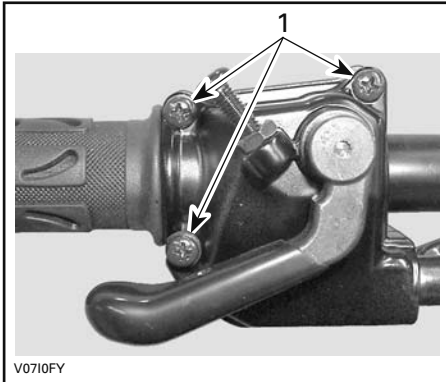

1. Remove these screws

Separate the housing.

Slide rubber protector back to expose throttle cable adjuster.

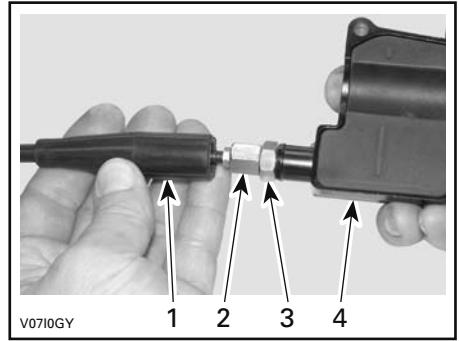

1. Cable protector
2. Throttle cable adjuster
3. Lock nut
4. Throttle lever housing

Screw in the throttle cable adjuster.
Remove inner housing protector.

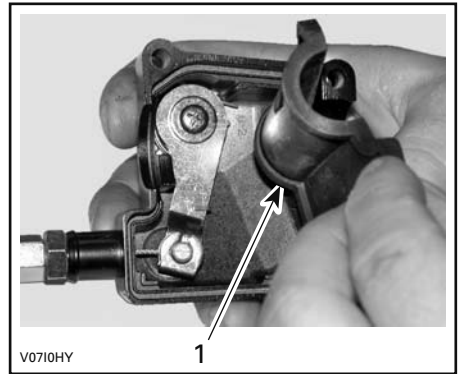

1. Inner housing protector

Remove the cable from the throttle lever housing.

NOTE: Slide cable in clip slot and remove the end of cable from clip.



V0710IY

Remove the throttle body side cover.

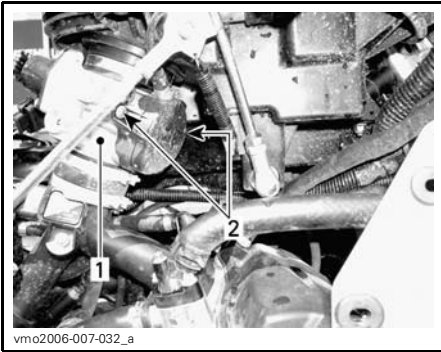

vm02006-007-032_a

1. Throttle body
2. Side cover screws

Insert the needle of the lubricant can in the end of throttle cable adjuster.



V0710JY

TYPICAL

NOTE: Place a rag around the throttle cable adjuster to prevent the lubricant from splashing.

Add lubricant until it runs out at throttle body end of the throttle cable.

Reinstall and adjust the cable.

Throttle Cable Adjustment

Slide rubber protector back to expose throttle cable adjuster.

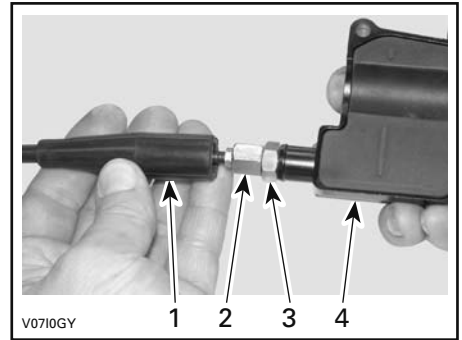

V0710GY

1. Cable protector
2. Throttle cable adjuster
3. Lock nut
4. Throttle lever housing

Loosen lock nut then turn the adjuster to obtain correct throttle lever free play.

NOTE: Measure throttle free play at the tip of throttle lever.

Tighten lock nut and reinstall protector.

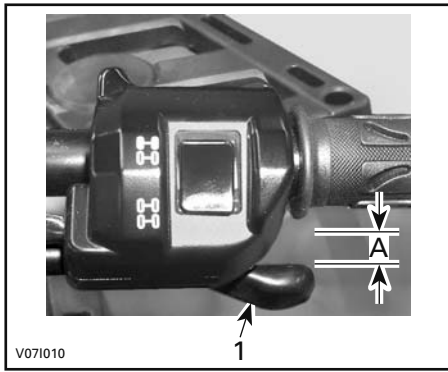

- 1. Throttle lever
- A. 2 mm (.079 in)

With the shift lever on PARK position, start the engine.

Check if the throttle cable is adjusted correctly by turning handlebar fully to the right then fully to the left. If the engine revolutions per minute (RPM) increases, readjust the throttle lever free play.

Spark Plugs

Spark Plug Access

- Remove side panels.
- Unplug spark plug cables.

Spark Plug Removal

- Unscrew spark plugs one turn.
- Clean spark plugs and cylinder heads with pressurized air if possible.
- Unscrew spark plugs completely using a spark plug socket, then remove them.

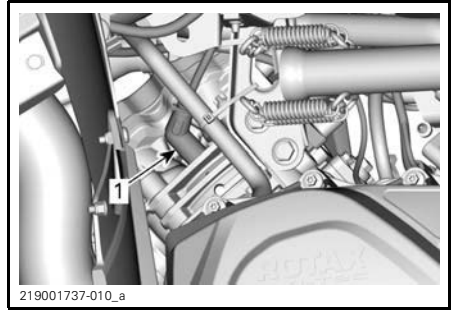

219001737-010_a
LH SIDE — FRONT CYLINDER
 1. Spark plug

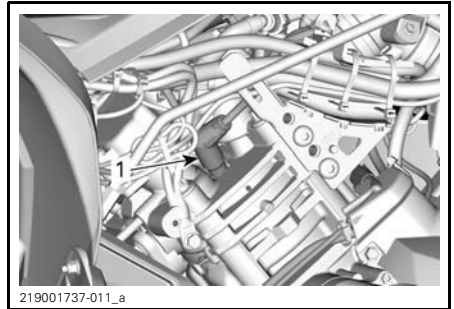

219001737-011_a
RH SIDE — REAR CYLINDER
 1. Spark plug

Spark Plug Installation

Prior to installation, make sure that contact surfaces of cylinder heads and spark plugs are free of grime.

Using a feeler gauge, set the spark plug gap.

SPARK PLUG GAP	
570 and 650 engines	0.8 mm to 0.9 mm (.031 in to .035 in)
850 and 1000R engines	0.7 mm to 0.9 mm (.028 in to .035 in)

Apply a small amount of copper-based anti-seize lubricant over spark plug threads.

Screw spark plugs into cylinder heads by hand and tighten with a torque wrench and a proper socket.

⚠ CAUTION Do not overtighten spark plugs, engine damage can occur.

TIGHTENING TORQUE	
570 and 650 engines	20 N•m ± 2.4 N•m (15 lbf•ft ± 2 lbf•ft)
850 and 1000R engines	11 N•m ± 1 N•m (97 lbf•in ± 9 lbf•in)

CVT Cover

NOTE: For a better understanding, some illustrations are taken with engine out of vehicle. To perform the following instructions, it is not necessary to remove engine.

This CVT is lubrication free. Never lubricate any components except drive pulley bearing.

⚠ WARNING
Never touch CVT while engine is running. Never drive vehicle when CVT cover is removed.

⚠ WARNING
Engine must be cool before cover is removed. Always wear protective gloves when removing cover.

Place the vehicle on a level surface. Select PARK position.

CVT Cover Access

The CVT cover is located on the LH side of the vehicle.

Remove the following:

- LH side and extension panels
- LH footboard panel.

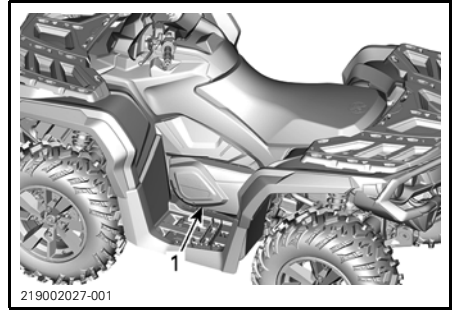

TYPICAL
1. CVT cover

CVT Cover Removal

Remove all CVT cover retaining screws.

Remove the center top screw last to support the cover during removal.

NOTICE Do not use an impact tool to remove CVT cover screws.

Remove the CVT cover and its gasket.

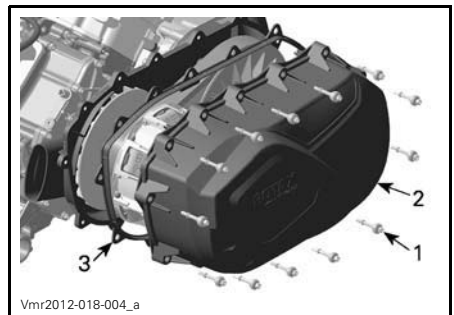

1. CVT cover screw
2. CVT cover
3. Gasket

CVT Cover Installation

Install the center top screw of first.

NOTE: Do not use an impact tool to install CVT cover screws.

Tighten the CVT cover screws as per following sequence.

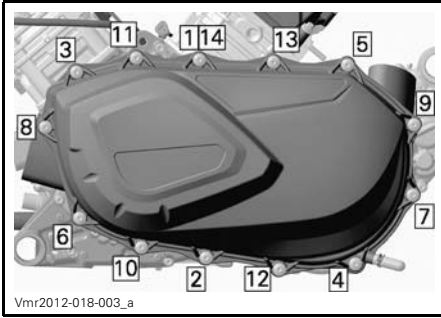

CVT COVER TIGHTENING SEQUENCE

TIGHTENING TORQUE	
CVT cover screws	7 N•m ± 0.8 N•m (62 lb•in ± 7 lb•in)

Drive Belt

Drive Belt Removal

NOTICE In case of a drive belt failure, the CVT, cover, drain reservoir and air outlet must be cleaned and inspected for obstruction.

Remove *CVT COVER*.

Open driven pulley.

REQUIRED TOOL	
PULLER/LOCKING TOOL (P/N 529 036 098)	

Screw tool in the threaded hole of driven pulley and tighten to open the pulley.

Slide the belt over the top edge of fixed sheave to remove it.

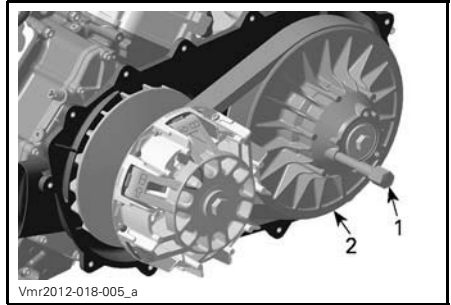

1. Puller/locking tool
2. Fixed sheave of driven pulley

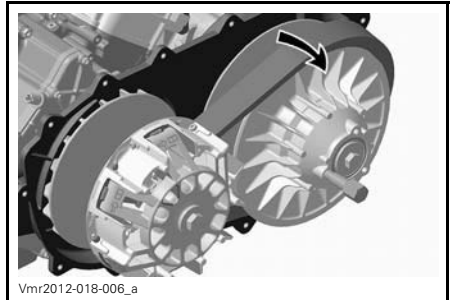

Drive Belt Installation

For installation, reverse the removal procedure. Pay attention to the following details.

The maximum drive belt life span is obtained when the drive belt has the proper rotation direction. Install it so that the arrow printed on belt is pointing towards front of the vehicle, viewed from top.

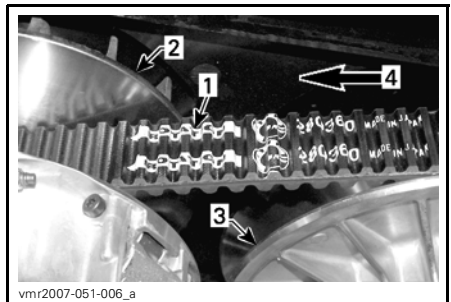

1. Arrow printed on belt
2. Drive pulley (front)
3. Driven pulley (rear)
4. Rotation direction

Turn the driven pulley until the lowest portion of the cogs on the external surface of drive belt is even with the driven pulley edge.



1. Lowest portion of cogs even with external surface of drive belt

Battery

⚠ WARNING

Unless otherwise indicated, always turn ignition switch to the OFF position before performing any maintenance or repair on electrical system.

⚠ CAUTION Never charge a battery while installed in vehicle.

These vehicles are equipped with a VRLA battery (Valve Regulated Lead Acid). It is a maintenance-free type battery, there is no need to add water to adjust electrolyte level.

NOTICE Never remove the battery sealing cap.

Battery Removal

NOTICE Always disconnect BLACK (-) battery cable first.

Disconnect BLACK (-) cable first then RED (+) cable.

Remove the retaining screws and the battery holder, then pull the battery out of frame.

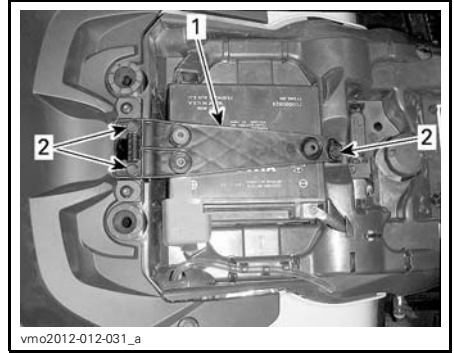

1. Battery holder
2. Retaining screws

Battery Cleaning

Clean battery, battery casing and battery posts using a solution of baking soda and water.

Remove corrosion from battery cable terminals and battery posts using a firm wire brush.

Battery Installation

Reinstall battery in vehicle.

NOTICE Always connect RED (+) battery cable first.

Fuses

⚠ CAUTION Always turn the ignition switch to OFF position or remove D.E.S.S. key from D.E.S.S. post before replacing a defective fuse.

Fuse Inspection

Check if filament is melted.

If filament is melted, replace damaged fuse, refer to the appropriate *FRONT FUSE BOX DESCRIPTION* for proper rating.

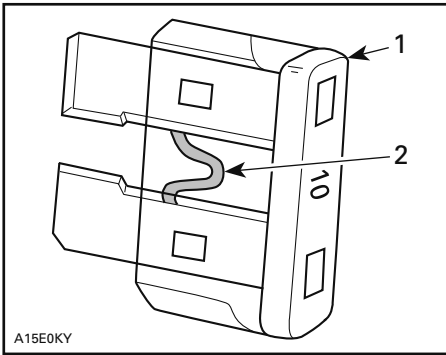

A15E0KY

TYPICAL

1. Fuse
2. Check if melted

NOTICE Do not use a higher rated fuse as this can cause severe damage.

Front Fuse Box Access

Refer to *EQUIPMENT* section and remove:

- Radiator cover
- Gauge support.

Remove the cover from the front fuse box.

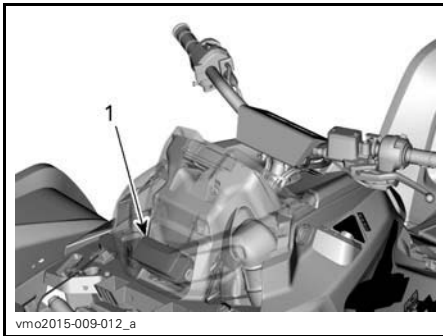

vmo2015-009-012_a

TYPICAL

1. Front fuse box

Front Fuse Box Description

NOTE: Check inside fuse box cover to know fuses location.

MODELS EQUIPPED WITH 570 ENGINES		
NO.	DESCRIPTION	RATING
RY1	Fan Relay	-
RY2	Main Relay	-
RY3	Accessories Relay	-
RY4	Fuel Pump Relay	-
RY8	Brake Relay	-
F4	Relays Gauge (Speedo)	10 A
F5	Injectors/ Ignition coils, Fuel Pump	10 A
F8	Key switch/ Starter Solenoid	10A
F9	Cooling Fan	20 A
F12	DC Outlet/Light/Accessories,	20 A

ALL MODELS EXCEPT 570 ENGINES		
NO.	DESCRIPTION	RATING
RY1	Fan Relay	-
RY2	Main Relay	-
RY3	Accessories Relay	-
RY4	Fuel Pump Relay	-
RY8	Brake Relay	-
F4	Relays Gauge (Speedo)	5 A
F5	Injectors/Ignition coils,	5 A
F6	ECM Module 2WD/4WD	5 A
F7	Winch (if equipped)	
F9	Cooling Fan	25 A
F11	Headlights	30 A

ALL MODELS EXCEPT 570 ENGINES		
NO.	DESCRIPTION	RATING
F12	DC Outlet/Light/Accessories,	15 A
F14	Accessories Taillights	15 A
F15	Fuel Pump	5 A

Rear Fuse Holder and Fusible Links

Models equipped with 570 engines sold outside North America

The rear fuse holder is located under the seat near the battery.



1. Fuse links

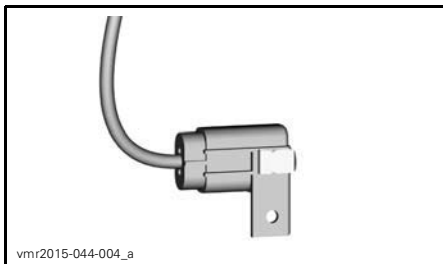

FUSE HOLDER

FUSE HOLDER	
DESCRIPTION	Rating
DPS (Dynamic Power Steering)	40 A

FUSIBLE LINKS		
DESCRIPTION		Gauge
Fusible link 1	Main	16 awg
Fusible link 2	Cooling fan Accessories	16 awg

Rear Fuse Holder

Except models equipped with 570 engines sold outside North America

The fusible links and rear fuse holder are located behind the RH side panel.

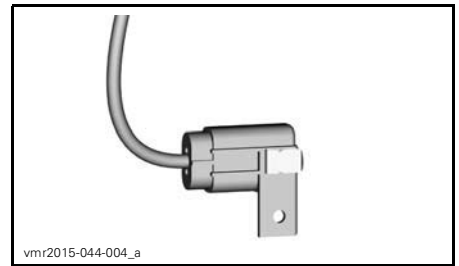

REAR FUSE HOLDER

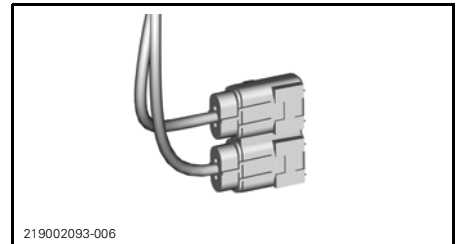

FUSE BOX 2

FUSE HOLDER	
DESCRIPTION	Rating
DPS (Dynamic Power Steering)	40 A
Main	40 A

Lights (570 Models)

CAUTION Always turn the ignition switch to OFF position before replacing a defective bulb.

Always check light operation after replacement.

Headlight Bulb Replacement

NOTICE Never touch glass portion of a halogen bulb with bare fingers, it shortens its operating life. If glass is touched, clean it with isopropyl alcohol which will not leave a film on the bulb.

1. Remove cover.
2. Unplug connector.
3. Remove bulb.

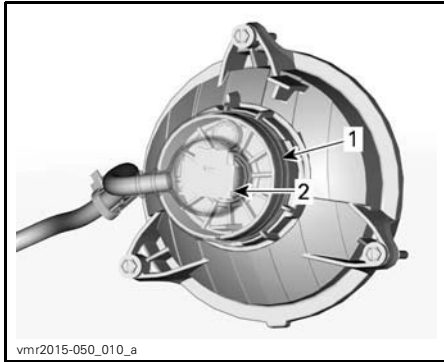

INSIDE FRONT FENDER

1. Cover
2. Connector

4. Properly reinstall removed parts in the reverse order of their removal.
5. Validate headlight operation.

Headlight Beam Aiming

Turn adjustment knobs to adjust beam height and side orientation to specification.

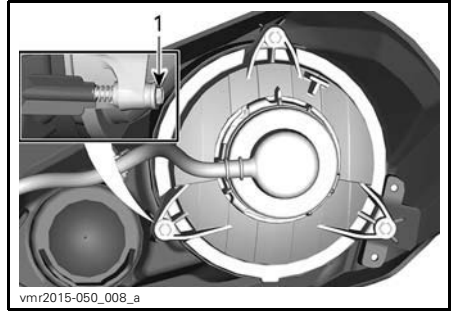

LOW BEAM

1. Adjustment knobs

Taillight/Brake Light Bulb Replacement

1. Unplug connector from bulb.
2. Rotate light bulb counterclockwise to remove it from taillight.

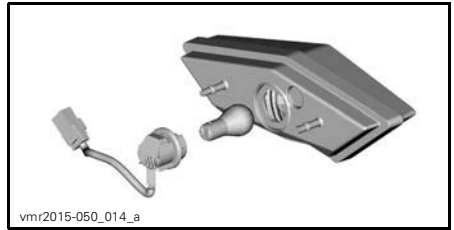

3. Remove bulb socket from taillight.

Installation is the reverse of the removal procedure.

Lights (650, 850 and 1000R Models)

CAUTION Always turn the ignition switch to OFF position before replacing a defective bulb.

Always check light operation after replacement.

Headlight Bulb Replacement

NOTICE Never touch glass portion of a halogen bulb with bare fingers, it shortens its operating life. If glass is touched, clean it with isopropyl alcohol which will not leave a film on the bulb.

Unplug connector from bulb.
 Rotate light bulb counterclockwise to release it from light housing.



INSIDE FRONT FENDER



Pull tail light out of its location.
 Unplug connector from bulb.
 Rotate light bulb counterclockwise to remove it from taillight.



Pull out bulb.
 Properly reinstall removed parts in the reverse order of their removal.
 Validate headlights operation.

Taillight/Brake Light Bulb Replacement

Rotate taillight counterclockwise to remove it from taillight housing.



Remove bulb socket from taillight.
 Installation is the reverse of the removal procedure.

Headlight Beam Aiming

Turn adjustment knobs to adjust beam height to your convenience.

NOTE: Adjust headlights evenly.

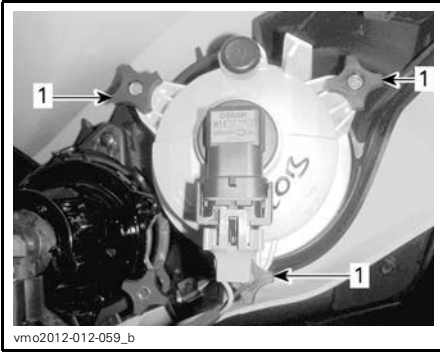

LOW BEAM ADJUSTMENT

1. Adjustment knobs



TYPICAL — FRONT OF VEHICLE

1. Drive shaft bellows
2. Drive shaft protector

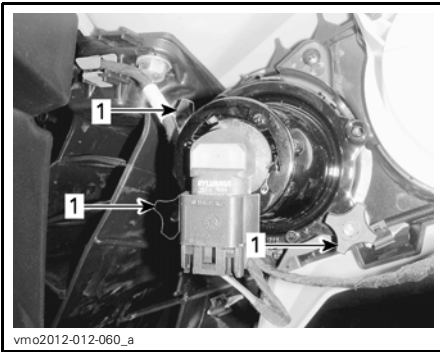

HIGH BEAM ADJUSTMENT

1. Adjustment knobs

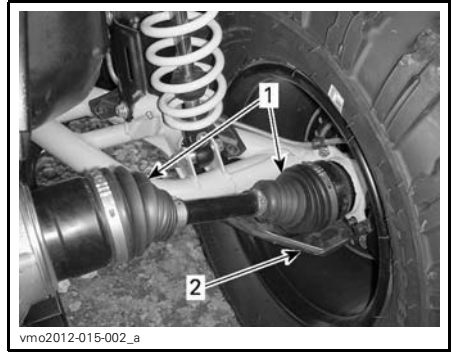

TYPICAL — REAR OF VEHICLE

1. Drive shaft bellows
2. Drive shaft protector

Drive Shaft Bellow and Protector

Drive Shaft Bellow and Protector Inspection

Visually inspect drive shaft protectors and bellows conditions.

Check protectors for damage or rubbing against shafts.

Check bellows for cracks, tears, leaking grease etc.

Repair or replace damaged parts as necessary.

Wheels and Tires

Tire Pressure

WARNING

Tire pressure greatly affects vehicle handling and stability. Insufficient pressure may cause tire to deflate and rotate on wheel. Overpressure may burst the tire. Always follow recommended pressure. NEVER set tire pressure below minimum. It could cause the tire to dislodge from the rim. Since tires are low-pressure types, a manual pump should be used.

Check pressure when tires are cold before using the vehicle. Tire pressure changes with temperature and altitude. Recheck pressure if one of these conditions has changed.

For your convenience, a pressure gauge is supplied in tool kit.

Refer to *SPECIFICATIONS* for values.

Although the tires are specifically designed for off-road use, a flat may still occur. Therefore, it is recommended to carry a tire pump and a repair kit.

Tire Inspection

Check tire for damage and wear. Replace if necessary.

The tires are directional and their rotation must be kept in a specific direction for proper operation.

Tire Replacement

Tires replacement should be performed by an authorized Can-Am dealer.

While reading this Operator's Guide, remember that:

WARNING

- When the tires are replaced, never install a bias tire with a radial tire. Such a combination could create handling and/or stability problems.
- Do not mix tires of different size and/or design on the same axle.
- Front and rear tire pairs must have an identical model and manufacturer.
- For unidirectional tread pattern, ensure that the tires are installed in the correct direction of rotation.
- The radial tires must be installed as a complete set.

Wheel Bearing Inspection

Place vehicle on a level surface.

Apply parking brake.

Lift vehicle.

Secure vehicle on jack stands.

Push and pull the wheels from the upper edge to feel the play.

See an authorized Can-Am dealer if there is an abnormal play.

WARNING

Indicates a potential hazard that, if not avoided, could result in serious injury or death.

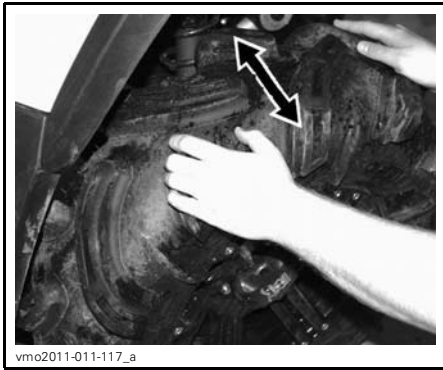

TYPICAL

Wheel Removal

- Place vehicle on a level surface.
- Engage 4WD mode.
- Apply the parking brake.
- Loosen lug nuts then lift vehicle.
- Secure vehicle on jack stands.
- Remove lug nuts, then remove wheel.

Wheel Installation

- At installation, it is recommended to apply anti-seize lubricant on threads.
- If tires are unidirectional, make sure to install wheel according to tire rotation.
- Carefully tighten lug nuts in a criss-cross sequence then apply final torque.

TIGHTENING TORQUE	
Wheel lug nut	80 N•m ± 5 N•m (59 lbf•ft ± 4 lbf•ft)

NOTE: Occasionally, wheel lug nuts should be removed to apply anti-seize lubricant on studs to ease future removal. This is particularly important when vehicle is used in salt-water environment or in mud. Remove one nut at a time, lubricate then retorque.

NOTICE Always use the recommended wheel lug nuts according to the type of wheel. Using a different lug nut could cause damage to the rim or studs.

Suspension

Front Suspension Lubrication

Lubricate front stabilizer bar links and suspension arms at grease fittings.

SERVICE PRODUCT
Synthetic suspension grease

Rear Suspension Lubrication

Lubricate rear stabilizer bar links and pivot bushing at grease fittings.

SERVICE PRODUCT
Synthetic suspension grease

Suspension Inspection

Shock Absorbers

- Inspect shock absorber for oil leaks or other damage.
- Check tightness of fasteners.
- See an authorized Can-Am dealer as necessary.

Ball Joints

- Place vehicle on a level surface.
- Apply parking brake.
- Lift vehicle.
- Secure vehicle on jack stands.
- Inspect ball joint boots for cracks.
- Push and pull the wheels from the upper and lower edge to feel the play.
- See an authorized Can-Am dealer if there is an abnormal play or if the boot is cracked.



TYPICAL

⚠ WARNING

The ball joint must be replaced if the boot is cracked or if it shows an abnormal play.

Front Suspension Arms

Check suspension arms for cracks, bending or other damage.

See an authorized Can-Am dealer as necessary.

Rear Trailing Arms

Check trailing arms for distortion, cracks or bending.

See an authorized Can-Am dealer if any problem is detected.

Steering

Steering Inspection

Tie Rod Ends

Place vehicle on a level surface.

Apply parking brake.

Lift vehicle.

Secure vehicle on jack stands.

Inspect tie rod boots for cracks.

Push and pull the wheels from the front or rear edge to feel the play.

See an authorized Can-Am dealer if there is an abnormal play or if the boot is cracked.

⚠ WARNING

The tie rod end must be replaced if the boot is cracked or if it shows an abnormal play.

Brakes

⚠ WARNING

New brakes will not operate at their maximum efficiency until their break-in is completed. Braking performance may be reduced, so use extra caution.

Brake Fluid Reservoir Level

NOTICE Use only DOT 4 brake fluid from a sealed container. Do not use brake fluid taken from old or already opened containers.

With vehicle on a level surface, check brake fluid in reservoirs for proper level. They should be above MIN. mark.

Add fluid as required. **Do not overfill.**

Clean filler cap before removing.

NOTE: A low level may indicate leaks or worn brake pads. See an authorized Can-Am dealer.

Brake Lever Fluid Reservoir(s)

Turn steering in the straight-ahead position to ensure reservoir is level.

Check the brake fluid level. The reservoir is full when the fluid reaches the top of window.

Visually inspect lever boot condition.

Check for cracks, tears, etc. Replace if damaged.



vmo2012-012-046_a

TYPICAL

Brake Pedal Fluid Reservoir

With vehicle on a level surface, liquid should be between MIN. and MAX. level marks of brake pedal fluid reservoir.

NOTICE Do not store any objects in the front service compartment.

Adding Brake Fluid

Clean filler cap.

⚠ WARNING

Clean filler cap before removing.

Remove screws retaining the reservoir cap.

Remove reservoir cap.

Add fluid as required using a clean funnel. Do not overfill.

NOTICE Brake fluid can damage plastic and painted surface. Wipe off and clean any spillage.

Reinstall reservoir cap and tighten screws.

NOTE: Ensure filler cap diaphragm is pushed inside the cap before closing the brake fluid reservoir.

Recommended Brake Fluid

Always use DOT 4 brake fluid from a sealed container.

⚠ WARNING

To avoid damage to the braking system, do not use other brake fluid types.

Brake Inspection

⚠ CAUTION The brakes can be very hot after prolonged use of the vehicle and can cause burns. Wait for the brakes to cool down.

The brake inspection, maintenance and repair should be performed by an authorized Can-Am dealer.

However, verify the following between visits to your dealer:

- Brake fluid level
- Brake system for fluid leaks
- Brake cleanliness.

⚠ WARNING

The brake fluid replacement or brake system maintenance and repairs should be performed by an authorized Can-Am dealer.

VEHICLE CARE

Post-Operation Care

To preserve the vehicle and its components, clean the vehicle with fresh water as per the *VEHICLE CLEANING AND PROTECTION* recommendations whenever the vehicle is used in the following conditions:

- Muddy conditions
- Salt-water environment.

NOTE: In salt-water environment, it is also recommended to protect metallic parts with LUBRICANT AND ANTI-CORROSIVE (P/N 779168) or an equivalent.

NOTICE When reinstalling the gauge support over air filter housing, ensure that all vent hoses are routed properly close to the air duct.

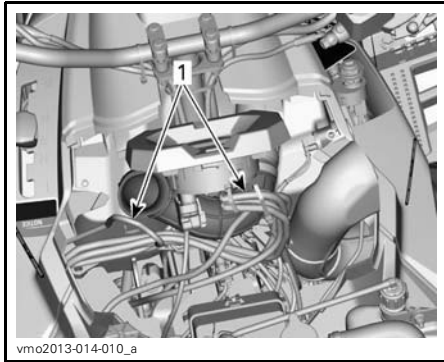

SUPPORT CONSOLE REMOVED FOR CLARITY - 570, 650 AND 850 MODELS
1. Route vent hoses close to air duct

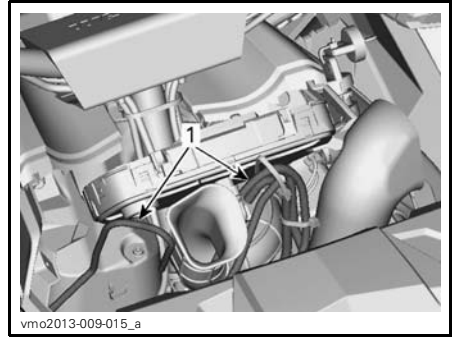

SUPPORT CONSOLE REMOVED FOR CLARITY - 1000R MODEL
1. Route vent hoses close to air duct

Vehicle Cleaning and Protection

NOTICE Never use a high pressure washer to clean the vehicle. USE LOW PRESSURE ONLY (like a garden hose).

Pay attention to certain areas where mud or debris can accumulate and potentially cause wear, interferences or promote corrosion.

Wash the vehicle with a soapy water solution.

NOTICE Never clean polypropylene body parts with any petroleum base cleaning products, as it will alter the glossy finish.

Non Compatible Cleaning Products

MATERIAL TYPE	NON-COMPATIBLE CLEANING PRODUCTS
Polypropylene	ANY PETROLEUM BASE CLEANING PRODUCTS
	XPS ATV FINISHING SPRAY (P/N 219 701 704)
	XPS ATV CLEANING KIT (P/N 219 701 713) (it contains the above XP-S ATV Finishing Spray)



vbs2012-006-001
SAFE FOR POLYPROPYLENE



vbs2012-006-002_a
DO NOT USE ON POLYPROPYLENE

Compatible Cleaning Products

MATERIAL TYPE	COMPATIBLE CLEANING PRODUCT
Polypropylene	XPS ATV WASH (P/N 219 701 702)
	Soapy water

STORAGE AND PRESEASON PREPARATION

WARNING

Have an authorized Can-Am dealer inspect fuel system integrity as specified in *MAINTENANCE SCHEDULE* section.

When a vehicle is not in use for more than four (4) months, proper storage is a necessity.

When using your vehicle after storage, a preparation is required.

See an authorized Can-Am dealer, repair shop or person of your own choosing to have your vehicle prepared for either storage or the preseason.

TECHNICAL INFORMATION

VEHICLE IDENTIFICATION

The main components of your vehicle (engine and frame) are identified using different serial numbers. It may sometimes become necessary to locate these numbers for warranty purposes or to trace your vehicle in the event of loss. These numbers are also required by the authorized Can-Am dealer to complete warranty claims properly. We strongly recommend that you take note of all the serial numbers on your vehicle and supply them to your insurance company.

Vehicle Identification Number

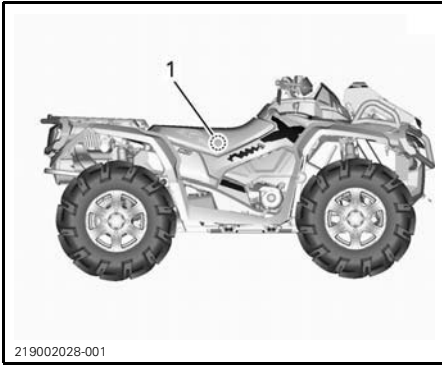

219002028-001

TYPICAL - 1000R MODEL SHOWN

1. VIN Label - On the frame under the seat



TYPICAL - VIN LABEL

Engine Identification Number

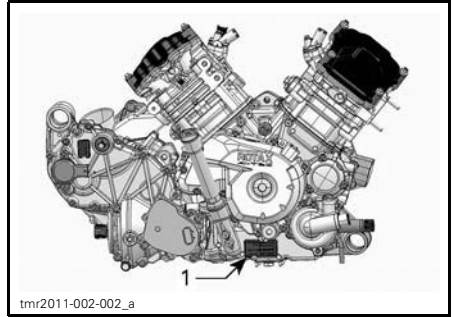

tmr2011-002-002_a

TYPICAL — RH SIDE OF ENGINE

1. EIN (Engine Identification Number)

Compliance Label

Regulation (EU) 2016/1628 applicable for Non-Road Mobile Machineries

Vehicles who comply to Regulation (EU) 2016/1628 (NRMM) are identified on the engine valve cover as well as on the frame under the seat.

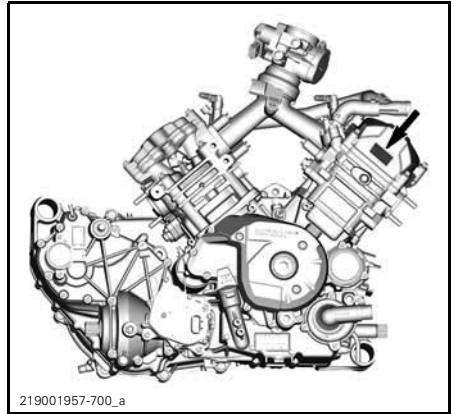

219001957-700_a

TYPICAL

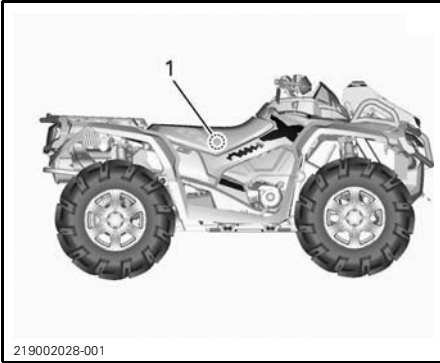

219002028-001
TYPICAL - 1000R MODEL SHOWN
 1. NRMM Label - On the frame under the seat

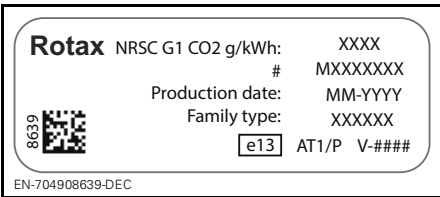

TYPICAL - NRMM IDENTIFICATION LABEL

Radio Frequency Digitally Encoded Security System (RFD.E.S.S. key)

This device complies with FCC Part 15 and Industry Canada license exempt RSS standard(s). Operation is subject to the following two conditions: (1) this device may not cause interference, and (2) this device must accept any interference, including interference that may cause undesired operation of the device.

Changes or modifications not expressly approved by the party responsible for compliance could void the user's authority to operate the equipment.

IC Registration Number: 12006A-M01456

FCC ID: 2ACERM01456

We, the party responsible for compliance, declare under our sole responsibility that the device is in conformity with the provisions of the following Council Directive: 2014/53/EU. To which this declaration relates is in conformity with the essential requirements and other relevant requirements. The product is in conformity with the following directives, harmonized standards and regulations: Radio Equipment Directive (RED) 2014/53/EU and Harmonized Standards: EN 300 330-2, EN 60950-1.

NOISE EMISSION CONTROL SYSTEM REGULATION (CANADA/UNITED STATES)

Tampering with Noise Control System is Prohibited!

U.S. Federal law and Canadian provincial laws may prohibit the following acts or the causing there of:

1. The removal or rendering inoperative by any person other than for purposes of maintenance, repair or replacement of any device or element of design incorporated into any new vehicle for the purpose of noise control prior to its sale or delivery to the ultimate purchaser or while it is in use or
2. The use of the vehicle after such device or element of design has been removed or rendered inoperative by any person.

Among those Acts Presumed to Constitute Tampering Are the Acts Listed Below:

1. Removal or alteration or the puncturing of the muffler or any engine component which conducts removal of engine exhaust gases.
2. Removal or alteration or the puncturing of any part of the intake system.
3. Replacing any moving parts of the vehicle or parts of the exhaust or intake system, with parts other than those specified by the manufacturer.
4. Lack of proper maintenance.

NOISE EMISSION AND VIBRATION VALUES (ALL COUNTRIES EXCEPT CANADA/UNITED STATES)

MODEL		Outlander 570 X mr	Outlander 650 X mr	Outlander 850 X mr	Outlander 1000R X mr
NOISE EMISSION AND VIBRATION VALUES ¹					
Noise	Sound pressure (L _{pA})	81 dB @ 4000 RPM (Uncertainty (K _{pA}) 3 dB)	78 dB @ 3600 RPM (Uncertainty (K _{pA}) 3 dB)	80 dB @ 4000 RPM (Uncertainty (K _{pA}) 3 dB)	80 dB @ 4000 RPM (Uncertainty (K _{pA}) 3 dB)
	Sound power level (L _{WA})	96 dB @ 4000 RPM (Uncertainty (K _{WA}) 3 dB)	-	-	-
Vibration	Hand-arm system	<2.5 m/s ² @ 4000 RPM	3.5 m/s ² @ 4000 RPM	3.5 m/s ² @ 4000 RPM	<2.5 m/s ² @ 4000 RPM
	Whole body at seat	<0.5 m/s ² @ 4000 RPM	<0.5 m/s ² @ 3600 RPM	<0.5 m/s ² @ 4000 RPM	<0.5 m/s ² @ 4000 RPM
¹ : Noise emission and Vibration values are measured in accordance with Standard EN 15997:2011 on a paved surface, at Neutral.					

EC-DECLARATION OF CONFORMITY



555 de la Montagne Street
Valcourt (Québec) J0E 2L0
Canada
www.brp.com

EU Declaration of Conformity

Authorized Representative: BRP Europe N.V., Skaldenstraat 125, Gent, Belgium, 9042

This declaration of conformity is issued under the sole responsibility of the manufacturer.

The undersigned, representing the manufacturer, hereby declares that model year **2021 All Terrain Vehicles (ATVs)** marked with the **CE** mark and a 17-character vehicle identification number (VIN) structured as **3JBxxxxxxMxxxxxxx** under commercial names **Can-am Outlander** and **Can-am Renegade** comply with all the relevant provisions of the following Directives and Regulations:

Machinery Directive 2006/42/EC as amended up to and including Reg. 2019/1243/EU	ISO 12100:2010 & EN 15997:2011
Non-Road Mobile Machinery (NRMM) Regulation (EU) 2016/1628 on gaseous pollutants	Category ATS, Stage V emissions limits.
Electromagnetic Compatibility (EMC) Directive 2014/30/EU as amended up to and including Reg. (EU) 2018/1139	CISPR 12:2007/A1:2009 & IEC 61000-6-1:2005 or UN R10.04 or later version
Battery Directive 2006/66/EC as amended up to and including Dir. (EU) 2018/849	
Radio Equipment (RED) Directive 2014/53/EU as amended up to and including Reg. 2018/1139 (If fitted with radio frequency (RF) D.E.S.S. key)	EN 300 330-2 & EN 60950-1

Renald Plante, Eng.
Director, Product Development, Can-Am ATV & Spyder
Bombardier Recreational Products Inc.

Valcourt, QC, Canada

January 29th 2020

SKI-DOO LYNX SEAWOO EVINRUDE ROTAX CAN-AM

EAC DECLARATION OF CONFORMITY

*Left blank for Eurasian Conformity
mark where applicable*

SPECIFICATIONS

ENGINE			
Engine type		ROTAX®, 4-stroke, 2 cylinders (V-twin), liquid cooled	
Valve train		4 valves/cylinder (mechanical adjustment), single over head camshaft (SOHC) with timing chain	
Valve clearance	Intake	0.06 mm to 0.14 mm (.0024 in to .0055 in)	
	Exhaust	0.11 mm to 0.19 mm (.0043 in to .0075 in)	
Bore	570	84 mm (3.31 in)	
	650	82 mm (3.23 in)	
	850	94 mm (3.7 in)	
	1000R	91 mm (3.58 in)	
Stroke	570	51.4 mm (2.02 in)	
	650/850	61.5 mm (2.42 in)	
	1000R	75 mm (2.95 in)	
Displacement	570	570 cm ³ (34.8 in ³)	
	650	650 cm ³ (39.7 in ³)	
	850	854 cm ³ (52.1 in ³)	
	1000R	976 cm ³ (59.6 in ³)	
Exhaust system		Spark arrestor approved by USDA Forest Service Catalyst on NRMM models	
Air filter		Synthetic paper filter with foam	
LUBRICATION SYSTEM			
Type		Wet sump. Replaceable cartridge oil filter	
Oil filter		BRP Rotax paper type, replaceable	

LUBRICATION SYSTEM		
Engine oil	Capacity (oil change with filter)	2.0 L (2.1 qt (U.S. liq.))
	Recommended oil General purpose	4T 5W40 Synthetic blend oil
	Recommended oil Cold temperature	4T 0W40 Synthetic oil
	Recommended oil Warm temperature	4T 10W50 Synthetic oil
	If XPS products are not available	5W40 or 10W50 motor oil that meets the requirements for API service classification SJ, SL, SM or SN

COOLING SYSTEM		
Coolant	Recommended coolant	Extended life pre-mixed coolant
	If XPS products are not available	Use distilled water and antifreeze solution specifically designed for aluminum engines (50% distilled water, 50% antifreeze)
	Capacity	3.5 L (.92 U.S. gal.)

TRANSMISSION	
Type	CVT (Continuously Variable Transmission), sub-transmission with L/H/N/R/P, standard engine braking
Engagement RPM	1800 RPM

GEARBOX		
Type		Dual range (HI-LO) with park, neutral and reverse
Gearbox oil	Capacity	450 ml (15.22 U.S. oz)
	Recommended oil	75W140 Synthetic gear oil
	If XPS products are not available	Use a 75W140 API GL-5 synthetic gear oil

SPECIFICATIONS

ELECTRICAL SYSTEM			
Magneto generator output	570	500 W @ 6000 RPM	
	All other	625 W @ 6000 RPM	
Ignition system type		IDI (Inductive Discharge Ignition)	
Ignition timing		Not adjustable	
Spark plug	Quantity	2	
	Make and type	570 650	
	Gap		0.8 mm to 0.9 mm (.031 in to .035 in)
	Quantity	2	
	Make and type	850 1000R	
	Gap		0.7 mm to 0.9 mm (.028 in to .035 in)
Engine RPM limiter setting	Forward	8000 RPM	
	Reverse	15 km/h (9 MPH) (without override)	
Battery	Type	Maintenance free	
	Voltage	12 volts	
	Nominal rating	18 A•h	
	Power starter output	0.7 KW	
Headlights	High	570	HS1 35 W
		All other	2 x 60 W (HB3)
	Low	570	HS1 35 W
		All other	2 x 55 W (H11)
Taillights		2 x 5/21 W	
Fuses		Refer to <i>FUSES</i> in the <i>MAINTENANCE</i>	

FUEL SYSTEM		
Fuel delivery	570 650	Electronic Fuel Injection (EFI), 46 mm throttle body, 1 injector per cylinder
	850 1000R	Electronic Fuel Injection (EFI), 54 mm throttle body, 1 injector per cylinder
Fuel pump	Type	Electrical (in fuel tank)
Idle speed	650	1250 RPM (not adjustable)
	570 850 1000R	1400 RPM (not adjustable)

FUEL SYSTEM				
Fuel	Type	570 650 850	Regular unleaded gasoline Refer to <i>FUEL REQUIREMENTS</i>	
		1000R	Premium unleaded gasoline Refer to <i>FUEL REQUIREMENTS</i>	
	Minimum octane rating	570 650 850	87 Pump Posted AKI (92 RON or 95 E10 RON)	
		1000R	91 Pump Posted AKI (95 E10 RON)	
Fuel tank capacity		20.5 L (5.4 U.S. gal.)		
Fuel remaining when low fuel light turns ON		± 5 L (1.3 U.S. gal.)		
DRIVE SYSTEM				
Drive system type		Visco-Lok	Selectable 2WD/4WD	
		Visco-4Lok	Selectable 2WD, 4WD and 4WDLock	
Front drive		Visco-lok † OE auto-locking front differential		
		Visco-4Lok auto-locking and full lock front differential		
Front drive ratio		3.6:1		
Rear drive		570	Bevel Straight gear / Shaft driven final drive	
		All other	Straight bevel gear / final drive unit	
Rear drive ratio		3.6:1		
Front differential oil		Capacity	Visco-Lok 500 ml (17 U.S. oz)	
			Visco-4Lok 400 ml (14 U.S. oz)	
		Recommended oil	75W90 Synthetic gear oil	
		If XPS products are not available	Use synthetic gear oil 75W90 API GL-5	
Rear final drive oil		Capacity	250 ml (8.45 U.S. oz)	
		Recommended oil	75W140 Synthetic gear oil	
		If XPS products are not available	Use synthetic gear oil 75W140 API GL-5	
CV joint grease		XPS CV joint grease or an equivalent		
Propeller shaft grease		XPS propeller shaft grease or an equivalent		

SPECIFICATIONS

FRONT SUSPENSION			
Suspension type	570	Double A-arm with dive-control geometry	
	All other	Double suspension-arm with dive-control geometry and external stabilizer bar	
Shock absorber	Qty		2
	Type	570	Oil
		650	
		850	FOX† PODIUM† 1.5
1000R	FOX† PODIUM† 1.5		
Preload adjustment type		Threaded	

REAR SUSPENSION			
Suspension type		Torsional Trailing arm Independent (TTI) with external stabilizer bar	
Shock absorber	Qty		2
	Type	570	Oil
		650	
		850	FOX† PODIUM† 1.5
1000R			
Preload adjustment type		Threaded	

BRAKES		
Front brake	Qty	2
	Type	214 mm cross drilled disc brakes with hydraulic twin-piston calipers
Rear brake	Qty	1
	Type	214 mm cross drilled disc brake with hydraulic twin-piston caliper
Brake fluid	Capacity	260 ml (8.8 U.S. oz)
	Type	DOT 4
Caliper		Floating twin pistons (2 x 26 mm)
Brake pad material		Metallic
Minimum brake pad thickness		1 mm (.04 in)
Minimum brake disc thickness		4.0 mm (.157 in)
Maximum brake disc warpage		0.2 mm (.01 in)

TIRES			
Pressure			Recommended tire inflation pressure is found on the Tire Label
Minimum tire thread depth			3 mm (.118 in)
Size	Front	570 650	28 x 9 - 12 in
		850 1000R	30 x 9 - 14 in
	Rear	570 650	28 x 11 - 12 in
		850 1000R	30 x 9 - 14 in

WHEELS			
Type			Cast aluminum
Rim size	Front	570 650	30,5 x 15,2 cm (12 x 6 in)
		850 1000R	35,5 x 16,5 cm (14 x 6.5 in)
	Rear	570 650	30,5 x 19,1 cm (12 x 7.5 in)
		850 1000R	35,5 x 16,5 cm (14 x 6.5 in)
Wheel offset	Front	570 650	41.2 mm (1.62 in)
		850 1000R	32 mm (1.26 in)
	Rear	570 650	51 mm (2 in)
		850 1000R	32 mm (1.26 in)
Wheel nut torque			80 N•m ± 5 N•m (59 lbf•ft ± 4 lbf•ft)

DIMENSIONS		
Overall length	570	211 cm (83 in)
	650 850	224 cm (88 in)
	1000R	246 cm (97 in)
Overall width	570	116.8 cm (46 in)
	650	123 cm (48.5 in)
	850 1000R	127 cm (50 in)

SPECIFICATIONS

DIMENSIONS			
Overall height		570	124 cm (49 in)
		650	128 cm (50.5 in)
		850 1000R	131 cm (51.5 in)
Wheelbase		570 650 850	129.5 cm (51 in)
		1000R	149.9 cm (59 in)
Wheel track	Front	570	97.3 cm (38.3 in)
		650 850	103.5 cm (40.8 in)
		1000R	104.0 cm (40.9 in)
	Rear	570	92.5 cm (36.4 in)
		650 850 1000R	100.6 cm (39.6 in)
Ground clearance		570	29.7 cm (11.7 in)
		650	29.9 cm (11.8 in)
		850 1000R	33 cm (13 in)

WEIGHT AND LOADING CAPACITY			
Dry weight		570	382 kg (843 lb)
		650	396 kg (874 lb)
		850	450 kg (990 lb)
		1000R	460 kg (1,014 lb)
Rear rack		570	109 kg (240 lb)
		All other	90 kg (200 lb)
Rear storage compartment loading capacity		570	11 L (2.9 U.S. gal.) or 10 kg (22 lb)
		All other	21.4 L (5.7 U.S. gal.) or 10 kg (22 lb)
Total vehicle load allowed (including driver, all other loads and added accessories)			189 kg (417 lb)
Towing capacity			750 kg (1,654 lb)
Tongue capacity (including trailer and load)			75 kg (165 lb)
Winch capacity (if equipped)			1 588 kg (3,500 lb)

***This page is
intentionally blank***

TROUBLESHOOTING

TROUBLESHOOTING GUIDELINES

ENGINE DOES NOT TURN

1. Ignition switch is in the OFF position (570) or D.E.S.S. key is not installed on D.E.S.S. post (650/850/1000R).
 - Place switch to the ON position (570) or securely install key to D.E.S.S. post (650/850/1000R).
2. Engine stop switch.
 - Make sure that engine stop switch is in ON position.
3. Transmission is not set on PARK or NEUTRAL.
 - Models equipped with 570 and 650 engine and NRMM compliant: Set transmission either in PARK or in NEUTRAL or press the brake lever(s).
 - Except models equipped with 570 and 650 engine not NRMM compliant: Set transmission in NEUTRAL or press the brake lever(s).
4. Burnt fuse.
 - Check main fuse condition.
5. Weak battery or loose connections.
 - Check charging system.
 - Check connections and terminals condition.
 - Have the battery checked.
 - Contact an authorized Can-Am dealer.
6. Wrong D.E.S.S. key, multifunction gauge display shows BAD KEY.
 - Use the proper key for this vehicle.
7. Weak starter or loose connections.
 - Check starter connections.
 - Check starter relay.

ENGINE TURNS OVER BUT FAILS TO START

1. Flooded engine (spark plug wet when removed).

- *If the engine does not start and it fuel-flooded, the drowned mode can be activated to prevent fuel injection and to cut ignition while cranking. Proceed as follows:*

- *Insert key in ignition switch and turn to ON position (570) or install key on D.E.S.S. post (other models).*
- *Press completely and HOLD throttle lever.*
- *Press the engine START button.*

The engine should be cranked for 20 seconds. Release engine START button.

Release throttle lever and start/crank engine again to allow starting.

If it does not work:

- *Clean the spark plug caps area then remove them.*
- *Remove the spark plugs.*
- *Unplug injector electrical connector.*
- *Crank engine several times.*
- *Install new spark plugs if possible or clean and dry spark plugs.*
- *Start engine as explained above.*

If engine continues to flood, see an authorized Can-Am dealer.

NOTE: *Make sure to verify that there is no fuel in engine oil, if so, replace engine oil.*

2. No fuel to the engine (spark plug dry when removed).

- *Check fuel tank level.*
- *A failure of the fuel pump may have occurred.*
- *Check fuel pump fuse and relay.*
- *If engine does not start, seek service from an authorized Can-Am dealer, repair shop, or person of your own choosing for maintenance, repair, or replacement. Please refer to the US EPA EMISSION-RELATED WARRANTY contained herein for information about warranty claims.*

3. Spark plug/ignition (no spark).

- *Check injectors/ignition fuse condition.*
- *Remove spark plug then reconnect to ignition coil.*
- *Check that ignition switch and/or engine stop switch is/are at the ON position.*
- *Start engine with spark plug grounded to the engine away from spark plug hole. If no spark appears, replace spark plug.*
- *If trouble persists, seek service from an authorized Can-Am dealer, repair shop or person of your own choosing for maintenance, repair or replacement. Please refer to the US EPA EMISSION-RELATED WARRANTY contained herein for information about warranty claims.*

4. Multifunction gauge CHECK ENGINE indicator lamp is on and display shows CHECK ENGINE.

- *Seek service from an authorized Can-Am dealer, repair shop or person of your own choosing for maintenance, repair or replacement. Please refer to the US EPA EMISSION-RELATED WARRANTY contained herein for information about warranty claims.*

ENGINE TURNS OVER BUT FAILS TO START (cont'd)

5. Engine is under a protection mode.

- Multifunction gauge CHECK ENGINE indicator lamp is on and display shows CHECK ENGINE, seek service from an authorized Can-Am dealer, repair shop or person of your own choosing for maintenance, repair or replacement. Please refer to the US EPA EMISSION-RELATED WARRANTY contained herein for information about warranty claims.

ENGINE LACKS ACCELERATION OR POWER

1. Fouled or damaged spark plug.

- Check item ENGINE TURNS OVER BUT FAILS TO START.

2. Lack of fuel to engine.

- Check item ENGINE TURNS OVER BUT FAILS TO START.

3. Engine is overheating.

- Check ENGINE OVERHEATS.

4. Air filter/housing plugged or dirty.

- Check air filter and clean if necessary.
- Check deposits in air filter housing drain.
- Check the position of the air intake tube.

5. CVT dirty or worn-out.

- Contact an authorized Can-Am dealer.

6. Engine is under a protection mode.

- Check multifunction gauge display for messages.
- Multifunction gauge CHECK ENGINE indicator lamp is on and display shows CHECK ENGINE or LIMP HOME, seek service from an authorized Can-Am dealer, repair shop or person of your own choosing for maintenance, repair or replacement. Please refer to the US EPA EMISSION-RELATED WARRANTY contained herein for information about warranty claims.

ENGINE OVERHEATS

1. Low coolant in cooling system.

- Check engine coolant, refer to MAINTENANCE PROCEDURES.

2. Dirty radiator fins.

- Clean radiator fins, refer to RADIATOR in MAINTENANCE PROCEDURES.

3. Cooling fan inoperative.

- Check cooling fan fuse or relay, refer to MAINTENANCE PROCEDURES. If the fuse is good, seek service from an authorized Can-Am dealer, repair shop or person of your own choosing for maintenance, repair or replacement. Please refer to the US EPA EMISSION-RELATED WARRANTY contained herein for information about warranty claims.

ENGINE BACKFIRE

1. Exhaust system leakage.

- *Seek service from an authorized Can-Am dealer, repair shop or person of your own choosing for maintenance, repair or replacement. Please refer to the US EPA EMISSION-RELATED WARRANTY contained herein for information about warranty claims.*

2. Engine is running too hot.

- *See ENGINE LACKS ACCELERATION OR POWER.*

3. Ignition timing is incorrect or there is an ignition system failure.

- *Seek service from an authorized Can-Am dealer, repair shop or person of your own choosing for maintenance, repair or replacement. Please refer to the US EPA EMISSION-RELATED WARRANTY contained herein for information about warranty claims.*

ENGINE MISFIRE

1. Fouled/damaged/worn spark plug.

- *Clean/verify spark plug and heat range. Replace as required.*

2. Water in fuel.

- *Drain fuel system and refill with fresh fuel.*

VEHICLE CANNOT REACH FULL SPEED

1. Engine.

- *See ENGINE LACKS ACCELERATION OR POWER.*

2. Parking brake.

- *Ensure parking brake is completely removed.*

3. Air filter/housing plugged or dirty.

- *Check air filter and clean if necessary.*
- *Check deposits in air filter housing drain.*
- *Check the position of the air intake tube.*

4. CVT dirty or worn-out.

- *Contact an authorized Can-Am dealer.*

5. Engine is under a protection mode.

- *Check multifunction gauge display for messages.*
- *Multifunction gauge CHECK ENGINE indicator lamp is on and display shows CHECK ENGINE or LIMP HOME, seek service from an authorized Can-Am dealer, repair shop or person of your own choosing for maintenance, repair or replacement. Please refer to the US EPA EMISSION-RELATED WARRANTY contained herein for information about warranty claims.*

SHIFT LEVER IS HARD TO MOVE

1. Transmission gears are in a position that prevents the shift lever to work.

- *Rock the vehicle back and forth to move the gears in the transmission and allow the shift lever to be set.*

SHIFT LEVER IS HARD TO MOVE (cont'd)

2. CVT dirty or worn-out.

- *Contact an authorized Can-Am dealer.*

THE RPM INCREASES BUT THE VEHICLE DOES NOT MOVE

1. The transmission is on PARK or NEUTRAL position.

- *Select the R, HI or LO position.*

2. CVT dirty or worn-out.

- *Contact an authorized Can-Am dealer.*

3. Water in the CVT.

- *See SPECIAL PROCEDURES.*

REDUCED POWER STEERING ASSIST

1. When DPS is subjected to sustained severe steering conditions, the assistance provided by the DPS motor may be reduced to protect the system.

- *Once the load is reduced, the normal steering assistance will return.*

2. CHECK ENGINE INDICATOR LAMP is ON and display shows CHECK DPS

- *Seek service from an authorized Can-Am dealer, repair shop or person of your own choosing for maintenance, repair or replacement.*

ANALOG/DIGITAL GAUGE MESSAGES

MESSAGE	PILOT LAMP(S) ON	DESCRIPTION
BAD KEY	Check engine	Indicates that you have used the wrong ignition key or D.E.S.S. key, use the proper key for this vehicle. Ignition key: It is also possible that the ignition key has a bad contact, remove and clean key.
DESS KEY NOT RECOGNIZED	Check engine	RF D.E.S.S. key: Indicates that there possibly is a bad contact, remove and clean key.
PARK BRAKE	Parking brake	Is displayed when parking brake is applied for more than 15 seconds (while riding).
LO BATT	Check engine	Low battery voltage, check battery voltage and charging system.
HI BATT	Check engine	High battery voltage, check battery voltage and charging system.
LOW OIL ⁽¹⁾	Check engine	Engine low oil pressure, stop engine immediately.
HI TEMP	Check engine	Engine is overheating, refer to <i>ENGINE OVERHEATS</i> in <i>TROUBLESHOOTING</i> .
LIMP HOME	Check engine	Serious fault on the engine that can change the normal operation of the engine, CHECK ENGINE indicator lamp will also blink, refer to <i>TROUBLESHOOTING</i> section.
CHECK ENGINE	Check engine	Engine fault, CHECK ENGINE indicator lamp will also be ON, refer to <i>TROUBLESHOOTING</i> .
NO ECM COMMUNICATION	Check engine	Communication error between speedometer and engine control module (ECM)
CHECK DPS	Check engine	Indicates that the DPS (Dynamic Power Steering) does not work properly. See an authorized Can-Am dealer.

MAINTENANCE REQUIRED ⁽²⁾	None	Displayed in gauge when vehicle is due for a maintenance
TPS FAULT PRESS OVERRIDE BUTTON TO LIMP HOME	Check engine	Throttle position sensor does not work properly. Seek service from an authorized Can-Am dealer, repair shop or person of your own choosing for maintenance, repair or replacement. Please refer to the US EPA Emissions-related warranty contained herein for information about warranty claims.

NOTICE ⁽¹⁾ If the message and the check engine light stays on after engine starting, stop engine. Check engine oil level. Refill if necessary. If the oil level is good, seek service from an authorized Can-Am dealer, repair shop or person of your own choosing for maintenance, repair or replacement. Please refer to the US EPA Emissions-related warranty contained herein for information about warranty claims. Do not use the vehicle until repaired.

⁽²⁾ To erase the MAINTENANCE REQUIRED message, proceed as follows:

1. From main display (vehicle speed), press SET and HOLD.
2. Alternate between LOW beam and HIGH beam 3 times.

NOTE: Step 2 must be completed within **2 seconds**.

3. Release SET button.

WARRANTY

BRP LIMITED WARRANTY USA AND CANADA: 2021 CAN-AM® ATV

SCOPE OF THE LIMITED WARRANTY

Bombardier Recreational Products Inc. ("BRP")* warrants its 2021 Can-Am ATV sold by authorized Can-Am ATV dealers (as hereinafter defined) in the United States of America ("USA") and in Canada from defects in material or workmanship for the period and under the conditions described below. This limited warranty will become null and void if: (1) the ATV was used for racing or any other competitive activity, at any point, even by a previous owner; or (2) the ATV has been altered or modified in such a way so as to adversely affect its operation, performance or durability, or has been altered or modified to change its intended use.

Non-factory installed parts and accessories are not covered under this limited warranty. Please refer to the applicable parts and accessories limited warranty text.

LIMITATIONS OF LIABILITY

THIS WARRANTY IS EXPRESSLY GIVEN AND ACCEPTED IN LIEU OF ANY AND ALL OTHER WARRANTIES, EXPRESSED OR IMPLIED, INCLUDING WITHOUT LIMITATION ANY WARRANTY OF MERCHANTABILITY OR FITNESS FOR A PARTICULAR PURPOSE TO THE EXTENT THAT THEY CANNOT BE DISCLAIMED, THE IMPLIED WARRANTIES ARE LIMITED IN DURATION TO THE LIFE OF THE EXPRESS WARRANTY. INCIDENTAL AND CONSEQUENTIAL DAMAGES ARE EXCLUDED FROM COVERAGE UNDER THIS WARRANTY SOME STATES/PROVINCES DO NOT ALLOW FOR THE DISCLAIMERS, LIMITATIONS AND EXCLUSIONS IDENTIFIED ABOVE, AS A RESULT, THEY MAY NOT APPLY TO YOU. THIS WARRANTY GIVES YOU SPECIFIC RIGHTS, AND YOU MAY ALSO HAVE OTHER LEGAL RIGHTS WHICH MAY VARY FROM STATE TO STATE, OR PROVINCE TO PROVINCE.

Neither the distributor, any BRP dealer nor any other person has been authorized to make any affirmation, representation or warranty regarding the product, other than those contained in this limited warranty, and if made, shall not be enforceable against BRP. BRP reserves the right to modify this limited warranty at any time, being understood that such modification will not alter the warranty conditions applicable to the products sold while this warranty is in effect.

EXCLUSIONS – ARE NOT WARRANTED

The following are not warranted under any circumstances:

- Normal wear and tear;
- Routine maintenance items, tune ups, adjustments;
- Damage caused by failure to provide proper maintenance and/or storage, as described in the Operator's Guide;
- Damage resulting from removal of parts, improper repairs, service, maintenance, modifications or use of parts not manufactured or approved by BRP or resulting from repairs done by a person that is not an authorized servicing Can-Am ATV dealer;
- Damage caused by abuse, abnormal use, neglect or operation of the product in a manner inconsistent with the recommended operation described in the Can-Am ATV Operator's Guide;
- Damage resulting from accident, submersion, fire, theft, vandalism or any act of God;

- Operation with fuels, oils or lubricants which are not suitable for use with the product (see the Operator’s Guide);
- Damages from rust, corrosion or exposure to the elements;
- Damage resulting from water or snow ingestion;
- Incidental or consequential damages, or damages of any kind including without limitation towing, storage, telephone, rental, taxi, inconvenience, insurance coverage, loan payments, loss of time, loss of income.

WARRANTY COVERAGE PERIOD

This limited warranty will be in effect from (1) the date of delivery to the first retail consumer or (2) the date the product is first put into use, whichever occurs first and for the applicable period below:

SIX (6) CONSECUTIVE MONTHS, for private use or commercial use owners. For emission-related components; please also refer to the *US EPA EMISSION-RELATED WARRANTY* contained herein.

The repair or replacement of parts or the performance of service under this warranty does not extend the life of this warranty beyond its original expiration date.

CONDITIONS TO HAVE WARRANTY COVERAGE

This warranty coverage is available **only** if **each** of the following conditions has been fulfilled:

- The 2021 Can-Am ATV must be purchased as new and unused by its first owner from a Can-Am ATV dealer authorized to distribute Can-Am ATVs in the country in which the sale occurred (“Can-Am ATV dealer”);
- The BRP specified pre-delivery inspection process must be completed and documented and signed by the purchaser;
- The 2021 Can-Am ATV must have undergone proper registration by an authorized Can-Am ATV dealer;
- The 2021 Can-Am ATV must be purchased in the country in which the purchaser resides;
- Routine maintenance outlined in the Operator’s Guide must be timely performed in order to maintain warranty coverage. BRP reserves the right to make warranty coverage contingent upon proof of proper maintenance.

BRP will not honor this limited warranty to any private use owner or commercial use owner if one of the preceding conditions has not been met. Such limitations are necessary in order to allow BRP to preserve both the safety of its products, and also that of its consumers and the general public.

WHAT TO DO TO OBTAIN WARRANTY COVERAGE

The customer must cease using the Can-Am ATV upon the appearance of an anomaly. The customer must notify a servicing BRP dealer within three (3) days of the appearance of a defect, and provide it with reasonable access to the product and reasonable opportunity to repair it. The customer must also present to the authorized BRP dealer, proof of purchase of the product and must sign the repair/work order prior to starting the repair in order to validate the warranty repair. All parts replaced under this limited warranty become the property of BRP.

WHAT BRP WILL DO

BRP's obligations under this warranty are limited to, at its sole discretion, repairing parts found defective under normal use, maintenance and service, or replacing such parts with new genuine Can-Am ATV parts without charge for parts and labor, at any authorized BRP dealer during the warranty coverage period under the conditions described herein. No claim of breach of warranty shall be cause for cancellation or rescission of the sale of the Can-Am ATV to the owner.

In the event that service is required outside of the country of original sale, the owner will bear responsibility for any additional charges due to local practices and conditions, such as, but not limited to, freight, insurance, taxes, license fees, import duties, and any and all other financial charges, including those levied by governments, states, territories and their respective agencies.

BRP reserves the right to improve or modify products from time to time without assuming any obligation to modify products previously manufactured.

ADDITIONAL SUPPLIER WARRANTIES

A GPS receiver may be supplied by BRP as standard equipment on certain 2021 Can-Am ATV's. The GPS receiver is covered under BRP's limited warranty policy. Additional warranty coverage if offered by the GPS receiver "supplier" that is longer than BRP's limited warranty is to be dealt by the dealer or consumer directly with the GPS receiver "supplier".

TRANSFER

If the ownership of a product is transferred during the warranty coverage period, this limited warranty, subject to its terms and conditions, shall also be transferred and be valid for the remaining coverage period provided BRP or an authorized Can-Am ATV Distributor/Dealer receives a proof that the former owner agreed to the transfer of ownership, in addition to the co-ordinates of the new owner.

CONSUMER ASSISTANCE

In the event of a controversy or a dispute in connection with this limited warranty, BRP suggests that you try to resolve the issue at the dealership level. We recommend discussing the issue with the authorized dealer's service manager or owner.

If the matter still remains unresolved, contact BRP by filling out the customer contact form at www.brp.com or contact BRP by mail at one of the addresses listed under the *CONTACT US* section of this guide.

* In the USA, products are distributed and serviced by BRP US Inc.

© 2020 Bombardier Recreational Products Inc. All rights reserved.

™ trademark of Bombardier Recreational Products Inc. or its affiliates.

® Registered trademark of Bombardier Recreational Products Inc.

US EPA EMISSION-RELATED WARRANTY

Bombardier Recreational Products Inc. (“BRP”)* warrants to the ultimate purchaser and each subsequent purchaser that this new vehicle, including all parts of its exhaust emission control system and its evaporative emission control system, meets two conditions:

1. It is designed, built, and equipped so it conforms at the time of sale to the ultimate purchaser with the requirements of 40 CFR 1051 and 40 CFR 1060.
2. It is free from defects in materials and workmanship that may keep it from meeting the requirements of 40 CFR 1051 and 40 CFR 1060.

Where a warrantable condition exists, BRP will repair or replace, as it elects, any part or component with a defect in materials or workmanship that would increase the engine’s emissions of any regulated pollutant within the stated warranty period at no cost to the owner, including expenses related to diagnosing and repairing or replacing emission-related parts. All defective parts replaced under this warranty become the property of BRP.

For all emission-related warranty claims, BRP is limiting the diagnosis and repair of emission-related parts to the authorized Can-Am dealers, unless for emergency repairs as required by item 2 of the following list.

As a certifying manufacturer, BRP will not deny emission-related warranty claims based on any of the following:

1. Maintenance or other service BRP or BRP’s authorized facilities performed.
2. Engine/equipment repair work that an operator performed to correct an unsafe, emergency condition attributable to BRP as long as the operator tries to restore the engine/equipment to its proper configuration as soon as possible.
3. Any action or inaction by the operator unrelated to the warranty claim.
4. Maintenance that was performed more frequently than BRP specify.
5. Anything that is BRP fault or responsibility.
6. The use of any fuel that is commonly available where the equipment operates unless BRP written maintenance instructions state that this fuel would harm the equipment’s emission control system and operators can readily find the proper fuel. See maintenance information section and fuel requirements of fueling section.

Emission-Related Warranty Period

The emission-related warranty is valid for the following period whichever comes first:

	HOURS	MONTHS	KILOMETERS
Exhaust emission-related components	500	30	5000
Evaporative emission-related components	N/A	24	N/A

Components Covered

The emission-related warranty covers all components whose failure would increase an engine's emissions of any regulated pollutant, including the following listed components:

1. For exhaust emissions, emission-related components include any engine parts related to the following systems:
 - Air-induction system
 - Fuel system
 - Ignition system
 - Exhaust gas recirculation systems
2. The following parts are also considered emission-related components for exhaust emissions:
 - Aftertreatment devices
 - Crankcase ventilation valves
 - Sensors
 - Electronic control units
3. The following parts are considered emission-related components for evaporative emissions:
 - Fuel tank
 - Fuel cap
 - Fuel line
 - Fuel line fittings
 - Clamps*
 - Pressure relief valves*
 - Control valves*
 - Control solenoids*
 - Electronic controls*
 - Vacuum control diaphragms*
 - Control cables*
 - Control linkages*
 - Purge valves
 - Vapor hoses
 - Liquid/vapor separator
 - Carbon canister
 - Canister mounting brackets
 - Carburetor purge port connector
4. Emission-related components also include any other part whose only purpose is to reduce emissions or whose failure will increase emissions without significantly degrading engine/equipment performance.

*As related to the evaporative emission control system

Limited Applicability

As a certifying manufacturer, BRP may deny emission-related warranty claims for failures that have been caused by the owner's or operator's improper maintenance or use, by accidents for which the manufacturer has no responsibility, or by acts of God. For example, an emission-related warranty claim need not be honored for failures that have been directly caused by the operator's abuse of the engine/equipment or the operator's use of the engine/equipment in a manner for which it was not designed and are not attributable to the manufacturer in any way.

If you have any question regarding your warranty rights and responsibility, you should contact Bombardier Recreational Products at 1-888-272-9222.

* In the USA, products are distributed and serviced by BRP US Inc.

BRP INTERNATIONAL LIMITED WARRANTY: 2021 CAN-AM® ATV

1) SCOPE OF THE LIMITED WARRANTY

Bombardier Recreational Products Inc. ("BRP")* warrants its 2021 Can-Am ATV sold by Can-Am ATV distributors or dealers authorized by BRP to distribute Can-Am ATVs ("Can-Am ATV Distributor/Dealer") outside of the United States of America ("USA"), Canada, member states of the European Economic Area (which is comprised of the member states of the European Union the United Kingdom, plus Norway, Iceland and Liechtenstein) ("EEA"), Turkey, member states of the Commonwealth of the Independent States (including Ukraine and Turkmenistan) ("CIS") and Turkey, from defects in material or workmanship for the period and under the conditions described below.

Non-factory installed parts and accessories are not covered under this limited warranty. Please refer to the applicable parts and accessories limited warranty text.

This limited warranty will become null and void if: (1) The ATV was used for racing or any other competitive activity, at any point, even by a previous owner; or (2) the ATV has been altered or modified in such a way so as to adversely affect its operation, performance or durability, or has been altered or modified to change its intended use.

2) LIMITATIONS OF LIABILITY

TO THE EXTENT PERMITTED BY LAW, THIS WARRANTY IS EXPRESSLY GIVEN AND ACCEPTED IN LIEU OF ANY AND ALL OTHER WARRANTIES, EXPRESSED OR IMPLIED, INCLUDING WITHOUT LIMITATION ANY WARRANTY OF MERCHANTABILITY OR FITNESS FOR A PARTICULAR PURPOSE. TO THE EXTENT THAT THEY CANNOT BE DISCLAIMED, THE IMPLIED WARRANTIES ARE LIMITED IN DURATION TO THE LIFE OF THE EXPRESS WARRANTY. INCIDENTAL AND CONSEQUENTIAL DAMAGES ARE EXCLUDED FROM COVERAGE UNDER THIS WARRANTY. SOME JURISDICTIONS DO NOT ALLOW FOR THE DISCLAIMERS, LIMITATIONS AND EXCLUSIONS IDENTIFIED ABOVE, AS A RESULT, THEY MAY NOT APPLY TO YOU. THIS WARRANTY GIVES YOU SPECIFIC RIGHTS AND YOU MAY ALSO HAVE OTHER LEGAL RIGHTS WHICH MAY VARY FROM COUNTRY TO COUNTRY. (FOR PRODUCTS PURCHASED IN AUSTRALIA SEE CLAUSE 4 BELOW).

Neither the Can-Am ATV Distributor/Dealer nor any other person has been authorized to make any affirmation, representation or warranty regarding the product, other than those contained in this limited warranty, and if made, shall not be enforceable against BRP.

BRP reserves the right to modify this warranty at any time, being understood that such modification will not alter the warranty conditions applicable to the products sold while this warranty is in effect.

3) EXCLUSIONS – ARE NOT WARRANTED

The following are not warranted under this limited warranty under any circumstances:

- Normal wear and tear;
- Routine maintenance items, tune ups, adjustments;
- Damage caused by negligence or failure to provide proper maintenance and/or storage, as described in the Operator's Guide;

- Damage resulting from removal of parts, improper repairs, service, maintenance, modifications or use of parts or accessories not manufactured or approved by BRP which in its reasonable judgement are either incompatible with the product or adversely affect its operation, performance and durability, or resulting from repairs done by a person that is not an authorized servicing Can-Am ATV Distributor/Dealer;
- Damage caused by abuse, abnormal use, neglect, racing or operation of the product in a manner inconsistent with the recommended operation described in the Operator's Guide;
- Damage resulting from accident, submersion, fire, snow or water ingestion, theft, vandalism or any act of God;
- Operation with fuels, oils or lubricants which are not suitable for use with the product (see the Operator's Guide);
- Damage resulting from rust, corrosion or exposure to the elements;
- Incidental or consequential damages, or damages of any kind including without limitation towing, storage, transportation expenses, telephone, rental, taxi, inconvenience, insurance coverage, loan payments, loss of time, loss of income; or time missed for downtime experience due to service work.

4) WARRANTY COVERAGE PERIOD

This warranty will be in effect from (1) the date of delivery to the first retail consumer or (2) the date the product is first put into use, whichever occurs first and for a period of:

SIX (6) CONSECUTIVE MONTHS for private use or commercial use.

In AUSTRALIA and NEW-ZEALAND only, this warranty will be in effect from (1) the date of delivery to the first retail consumer or (2) the date the product is first put into use, whichever occurs first, and for a period of (1) TWENTY-FOUR (24) CONSECUTIVE MONTHS or (2) a total use of FIFTEEN THOUSAND (15 000) kilometers, whichever occurs first, for private use or commercial use.

The repair or replacement of parts or the performance of service under this warranty does not extend the life of this warranty beyond its original expiration date.

Note that the duration and any other modalities of the warranty coverage are subject to the applicable national or local legislation in the customer's country.

FOR PRODUCTS SOLD IN AUSTRALIA ONLY

Nothing in these Warranty terms and conditions should be taken to exclude, restrict or modify the application of any condition, warranty, guarantee, right or remedy conferred or implied under the Competition and Consumer Act 2010 (Cth), including the Australian Consumer Law or any other law, where to do so would contravene that law, or cause any part of these terms and conditions to be void. The benefits given to you under this limited warranty are in addition to other rights and remedies that you have under Australian law.

Our goods come with guarantees that cannot be excluded under the Australian Consumer Law. You are entitled to a replacement or refund for a major failure and for compensation for any other reasonably foreseeable loss or damage. You are also entitled to have the goods repaired or replaced if the goods fail to be of acceptable quality and the failure does not amount to a major failure.

5) CONDITIONS TO HAVE WARRANTY COVERAGE

This warranty coverage is available **only** if **each** of the following conditions has been fulfilled:

- The 2021 Can-Am ATV must be purchased as new and unused by its first owner from a Can-Am ATV Distributor/Dealer authorized to distribute Can-Am ATVs in the country in which the sale occurred;
- The BRP specified pre-delivery inspection process must be completed and documented;
- The product must have undergone proper registration by an authorized Can-Am ATV Distributor/Dealer;
- The 2021 Can-Am ATV must be purchased in the country or union of countries in which the purchaser resides; and
- Routine maintenance outlined in the Operator's Guide must be timely performed in order to maintain warranty coverage. BRP reserves the right to make warranty coverage contingent upon proof of proper maintenance.

BRP will not honour this limited warranty to any private use owner or commercial use owner if one of the preceding conditions has not been met. Such limitations are necessary in order to allow BRP to preserve both the safety of its products, and also that of its consumers and the general public.

6) WHAT TO DO TO OBTAIN WARRANTY COVERAGE

The customer must cease using the ATV upon the appearance of an anomaly. The customer must notify a servicing Can-Am ATV Distributor/Dealer within two (2) days of the appearance of a defect, and provide it with reasonable access to the product and reasonable opportunity to repair it. The customer must also present to the authorized Can-Am ATV Distributor/Dealer proof of purchase of the product and must sign the repair/work order prior to starting the repair in order to validate the warranty repair. All parts replaced under this limited warranty become the property of BRP.

Note that the notification period is subject to the applicable national or local legislation in customer's country.

7) WHAT BRP WILL DO

To the extent permitted by law, BRP's obligations under this warranty are limited to, at its sole discretion, repairing parts found defective under normal use, maintenance and service, or replacing such parts with new genuine Can-Am ATV parts without charge for parts and labour, at any authorized Can-Am ATV Distributor/Dealer during the warranty coverage period under the conditions described herein. BRP's responsibility is limited to making the required repairs or replacements of parts. No claim of breach of warranty shall be cause for cancellation or rescission of the sale of the Can-Am ATV to the owner. You may have other legal rights which may vary from country to country.

In the event that service is required outside of the country of original sale, the owner will bear responsibility for any additional charges due to local practices and conditions, such as, but not limited to, freight, insurance, taxes, license fees, import duties, and any and all other financial charges, including those levied by governments, states, territories and their respective agencies.

BRP reserves the right to improve or modify products from time to time without assuming any obligation to modify products previously manufactured.

8) TRANSFER

If the ownership of a product is transferred during the warranty coverage period, this warranty shall also be transferred and be valid for the remaining coverage period provided BRP or an authorized Can-Am ATV Distributor/Dealer receives a proof that the former owner agreed to the transfer of ownership, in addition to the coordinates of the new owner.

9) CONSUMER ASSISTANCE

In the event of a controversy or a dispute in connection with this limited warranty, BRP suggests that you try to resolve the issue at the Can-Am ATV Distributor/Dealer level. We recommend discussing the issue with the authorized Can-Am ATV Distributor/Dealer's service manager or owner.

If the matter still remains unresolved, contact BRP by filling out the customer contact form at www.brp.com or contact BRP by mail at one of the addresses listed under the *CONTACT US* section of this guide.

* For the territory covered by this limited warranty, products are distributed and serviced by Bombardier Recreational Products Inc. or its affiliates.

© 2020 Bombardier Recreational Products Inc. All rights reserved.

™ Trademark of Bombardier Recreational Products Inc. or its affiliates.

® Registered trademark of Bombardier Recreational Products Inc.

BRP LIMITED WARRANTY FOR THE EUROPEAN ECONOMIC AREA, THE COMMONWEALTH OF THE INDEPENDENT STATES AND TURKEY: 2021 CAN-AM® ATV

1) SCOPE OF THE LIMITED WARRANTY

Bombardier Recreational Products Inc. ("BRP")* warrants its 2021 Can-Am ATVs sold by distributors or dealers authorized by BRP to distribute Can-Am ATVs ("Can-Am ATV Distributor/Dealer") in member states of the European Economic Area (which is comprised of the member states of the European Union plus the United Kingdom, Norway, Iceland and Liechtenstein) ("EEA"), in member states of the Commonwealth of the Independent States (including Ukraine and Turkmenistan) ("CIS") and Turkey from defects in material or workmanship for the period and under the conditions described below.

Non-factory installed parts and accessories are not covered under this limited warranty. Please refer to the applicable parts and accessories limited warranty text.

This limited warranty will become null and void if: (1) The ATV was used for racing or any other competitive activity, at any point, even by a previous owner; or (2) the ATV has been altered or modified in such a way so as to adversely affect its operation, performance or durability, or has been altered or modified to change its intended use.

2) LIMITATIONS OF LIABILITY

TO THE EXTENT PERMITTED BY LAW, THIS WARRANTY IS EXPRESSLY GIVEN AND ACCEPTED IN LIEU OF ANY AND ALL OTHER WARRANTIES, EXPRESSED OR IMPLIED, INCLUDING WITHOUT LIMITATION ANY WARRANTY OF MERCHANTABILITY OR FITNESS FOR A PARTICULAR PURPOSE. TO THE EXTENT THAT THEY CANNOT BE DISCLAIMED, THE IMPLIED WARRANTIES ARE LIMITED IN DURATION TO THE LIFE OF THE EXPRESS WARRANTY. INCIDENTAL AND CONSEQUENTIAL DAMAGES ARE EXCLUDED FROM COVERAGE UNDER THIS WARRANTY. SOME JURISDICTIONS DO NOT ALLOW FOR THE DISCLAIMERS, LIMITATIONS AND EXCLUSIONS IDENTIFIED ABOVE, AS A RESULT, THEY MAY NOT APPLY TO YOU. THIS WARRANTY GIVES YOU SPECIFIC RIGHTS AND YOU MAY ALSO HAVE OTHER LEGAL RIGHTS WHICH MAY VARY FROM COUNTRY TO COUNTRY.

Neither the Can-Am ATV Distributor/Dealer nor any other person has been authorized to make any affirmation, representation or warranty regarding the product, other than those contained in this limited warranty, and if made, shall not be enforceable against BRP.

BRP reserves the right to modify this warranty at any time, being understood that such modification will not alter the warranty conditions applicable to the products sold while this warranty is in effect.

3) EXCLUSIONS – ARE NOT WARRANTED

The following are not warranted under this limited warranty under any circumstances:

- Normal wear and tear;
- Routine maintenance items, tune ups, adjustments;

- Damage caused by negligence or failure to provide proper maintenance and/or storage, as described in the Operator's Guide;
- Damage resulting from removal of parts, improper repairs, service, maintenance, modifications or use of parts or accessories not manufactured or approved by BRP which in its reasonable judgement are either incompatible with the product or adversely affect its operation, performance and durability, or resulting from repairs done by a person that is not an authorized servicing Can-Am/Can-Am ATV Distributor/Dealer;
- Damage caused by abuse, abnormal use, neglect, racing or operation of the product in a manner inconsistent with the recommended operation described in the Operator's Guide;
- Damage resulting from accident, submersion, fire, snow or water ingestion, theft, vandalism or any act of God;
- Operation with fuels, oils or lubricants which are not suitable for use with the product (see the Operator's Guide);
- Damage resulting from rust, corrosion or exposure to the elements;
- Incidental or consequential damages, or damages of any kind including without limitation towing, transportation expenses, storage, telephone, rental, taxi, inconvenience, insurance coverage, loan payments, loss of time, loss of income or time missed for downtime experience due to service work.

4) WARRANTY COVERAGE PERIOD

This warranty will be in effect from (1) the date of delivery to the first retail consumer or (2) the date the product is first put into use, whichever occurs first and for a period of:

TWENTY-FOUR (24) CONSECUTIVE MONTHS for private use.

SIX (6) CONSECUTIVE MONTHS for commercial use or rental use.

The product is used commercially when it is used in connection with any work or employment that generates income during any part of the warranty period. The product is also used commercially when, at any point during the warranty period, it is licensed for commercial use.

The repair or replacement of parts or the performance of service under this warranty does not extend the life of this warranty beyond its original expiration date.

Note that the duration and any other modalities of the warranty coverage are subject to the applicable national or local legislation in the customer's country.

5) CONDITIONS TO HAVE WARRANTY COVERAGE

This warranty coverage is available **only** if **each** of the following conditions has been fulfilled:

- The 2021 Can-Am ATV must be purchased as new and unused by its first owner from a Can-Am ATV Distributor/Dealer authorized to distribute Can-Am ATVs in the country in which the sale occurred;
- The BRP specified pre-delivery inspection process must be completed and documented;
- The product must have undergone proper registration by an authorized Can-Am ATV Distributor/Dealer;

- The 2021 Can-Am ATV must be purchased within the EEA by an EEA resident, in the CIS for residents of the countries comprised in such area and in Turkey for residents of Turkey; and
- Routine maintenance outlined in the Operator's Guide must be timely performed in order to maintain warranty coverage. BRP reserves the right to make warranty coverage contingent upon proof of proper maintenance.

BRP will not honour this limited warranty to any private use owner or commercial use owner if one of the preceding conditions has not been met. Such limitations are necessary in order to allow BRP to preserve both the safety of its products, and also that of its consumers and the general public.

6) WHAT TO DO TO OBTAIN WARRANTY COVERAGE

The customer must cease using the ATV upon the appearance of an anomaly. The customer must notify a servicing Can-Am ATV Distributor/Dealer within two (2) months of the appearance of a defect and provide it with reasonable access to the product and reasonable opportunity to repair it. The customer must also present to the authorized Can-Am ATV Distributor/Dealer, proof of purchase of the product and must sign the repair/work order prior to starting the repair in order to validate the warranty repair. All parts replaced under this limited warranty become the property of BRP.

Note that the notification period is subject to the applicable national or local legislation in customer's country.

7) WHAT BRP WILL DO

To the extent permitted by law, BRP's obligations under this warranty are limited to, at its sole discretion, repairing parts found defective under normal use, maintenance and service, or replacing such parts with new genuine Can-Am ATV parts without charge for parts and labour, at any authorized Can-Am ATV Distributor/Dealer during the warranty coverage period under the conditions described herein. BRP's responsibility is limited to making the required repairs or replacements of parts. No claim of breach of warranty shall be cause for cancellation or rescission of the sale of the Can-Am ATV to the owner. You may have other legal rights which may vary from country to country.

In the event that service is required outside of the EEA, CIS or Turkey, the owner will bear responsibility for any additional charges due to local practices and conditions, such as, but not limited to, freight, insurance, taxes, license fees, import duties, and any and all other financial charges, including those levied by governments, states, territories and their respective agencies.

BRP reserves the right to improve or modify products from time to time without assuming any obligation to modify products previously manufactured.

8) TRANSFER

If the ownership of a product is transferred during the warranty coverage period, this warranty shall also be transferred and be valid for the remaining coverage period provided BRP or an authorized Can-Am ATV Distributor/Dealer receives a proof that the former owner agreed to the transfer of ownership, in addition to the co-ordinates of the new owner.

9) CONSUMER ASSISTANCE

In the event of a controversy or a dispute in connection with this limited warranty, BRP suggests that you try to resolve the issue at the Can-Am ATV Distributor/Dealer level. We recommend discussing the issue with the authorized Can-Am ATV Distributor/Dealer's service manager or owner.

If the matter still remains unresolved, contact BRP by filling out the customer contact form at www.brp.com or contact BRP by mail at one of the addresses listed under the *CONTACT US* section of this guide.

* In the EEA, products are distributed and serviced by BRP European Distribution S.A. and other affiliates or subsidiaries of BRP.

© 2020 Bombardier Recreational Products Inc. All rights reserved.

™ Trademark of Bombardier Recreational Products Inc. or its affiliates.

® Registered trademark of Bombardier Recreational Products Inc.

ADDITIONAL TERMS AND CONDITIONS FOR FRANCE ONLY

The following terms and conditions are applicable to products sold in France only:

The seller shall deliver goods that are complying with the contract and shall be responsible for defects existing upon delivery. The seller shall also be responsible for defects resulting from packaging, assembling instructions or the installation when it is its responsibility per the contract or if accomplished under its responsibility. To be compliant with the contract, the good shall:

1. Be fit for normal use for goods similar thereto and, if applicable:
 - Correspond to the description provided by the seller and have the qualities presented to the buyer through sample or model;
 - Have the qualities that a buyer may legitimately expect considering the public declarations of the seller, the manufacturer of its representative, including in advertising or labeling; or
2. Have the characteristics mutually agreed upon as between the parties or be fit for the specific use intended by the buyer and brought to the attention of the seller and which accepted by the seller.

The action for failure to comply is prescribed after two years after delivery of the goods. The seller is responsible for the warranty for hidden defects of the good sold if such hidden defects are rendering the good unfit for the intended use, or if they diminish its use in such a way that the buyer would not have acquired the good or would have given a lesser price, had he known. The action for such hidden defects shall be taken by the buyer within 2 years of the discovery of the defect.

MAINTENANCE RECORDS

Send photocopy of maintenance record to BRP if needed.

PREDELIVERY	
Serial number: _____ Mileage / km: _____ Hours: _____ Date: _____ Dealer no: _____ Notes: _____ _____	Signature/Print: _____
Refer to vehicle Pre-Delivery Bulletin for detailed installation procedures	

FIRST INSPECTION	
Mileage / km: _____ Hours: _____ Date: _____ Dealer no: _____ Notes: _____ _____	Signature/Print: _____
For maintenance schedule refer to Maintenance Information section of this operator's guide	

SERVICE	
Mileage / km: _____ Hours: _____ Date: _____ Dealer no: _____ Notes: _____ _____	Signature/Print: _____
For maintenance schedule refer to Maintenance Information section of this operator's guide	

SERVICE

Mileage / km: _____

Hours: _____

Date: _____

Dealer no: _____

Notes: _____

Signature/Print: _____

For maintenance schedule refer to Maintenance Information section of this operator's guide

SERVICE

Mileage / km: _____

Hours: _____

Date: _____

Dealer no: _____

Notes: _____

Signature/Print: _____

For maintenance schedule refer to Maintenance Information section of this operator's guide

SERVICE

Mileage / km: _____

Hours: _____

Date: _____

Dealer no: _____

Notes: _____

Signature/Print: _____

For maintenance schedule refer to Maintenance Information section of this operator's guide

SERVICE

Mileage / km:

Hours:

Date:

Dealer no:

Notes:

Signature/Print:

For maintenance schedule refer to Maintenance Information section of this operator's guide

SERVICE

Mileage / km:

Hours:

Date:

Dealer no:

Notes:

Signature/Print:

For maintenance schedule refer to Maintenance Information section of this operator's guide

CUSTOMER INFORMATION

PRIVACY INFORMATION

BRP wishes to inform you that your coordinates will be used for safety and warranty related purposes. Furthermore, BRP and its affiliates may use its customer list to distribute marketing and promotional information about BRP and related products.

To exercise your right to consult or correct your data, or to be removed from the addressee-list for direct marketing, please contact BRP.

By E-mail: privacyofficer@brp.com

By mail: BRP Legal Service
726 St-Joseph
Valcourt QC
Canada
J0E 2L0

CONTACT US

www.brp.com

Asia

Room 4609, Tower 2,
Grand Gateway 3 Hong Qiao
Road Shanghai,
China 200020

21F Shinagawa East One Tower
2-16-1 Konan, Minatoku-ku,
Tokyo 108-0075
Japan

Europe

Skaldenstraat 125
B-9042 Gent
Belgium

Itterpark 11
D-40724 Hilden
Germany

ARTEPARC Bâtiment B
Route de la côte d'Azur, Le Canet
13590 Meyreuil
France

Ingvald Ystgaardsvei 15
N-7484 Trondheim
Norway

Isoaavantie 7
PL 8040
96101 Rovaniemi

Spinnvägen 15
903 61 Umeå
Sweden

Avenue d'Ouchy 4-6
1006 Lausanne
Switzerland

North America

565 de la Montagne Street
Valcourt (Québec) J0E 2L0
Canada

Sa De Cv, Av. Ferrocarril 202
Parque Ind. Querétaro, Lote2-B
76220

Santa Rosa Jáuregui, Oro., Mexico
Sturtevant, Wisconsin, U.S.A.
10101 Science Drive
Sturtevant, Wisconsin
53177
U.S.A.

Oceania

6 Lord Street
Lakes Business Park
Botany, NSW 2019
Australia

3B Echelon Place, East Tamaki,
Auckland 2013,
New Zealand

South America

Rua James Clerck Maxwell, 230
TechnoPark Campinas SP 13069-380
Brazil

CHANGE OF ADDRESS/OWNERSHIP

If your address has changed or if you are the new owner of the ATV, be sure to notify BRP by either:

- Notifying an authorized Can-Am dealer.
- **North America Only:** calling at 1 888 272-9222.
- Mailing one of the change of address cards on the following pages at one of the BRP addresses indicated in the *CONTACT US* section of this guide.

In case of change of ownership, please join a proof that the former owner agreed to the transfer.

Notifying BRP, even after the expiration of the limited warranty, is very important as it enables BRP to reach the ATV owner if necessary, like when safety recalls are initiated. It is the owner's responsibility to notify BRP.

STOLEN UNITS: If your personal ATV is stolen, you should notify BRP or an authorized Can-Am dealer. We will ask you to provide your name, address, phone number, the vehicle identification number and the date it was stolen.

CHANGE OF ADDRESS

CHANGE OF OWNERSHIP



VEHICLE IDENTIFICATION NUMBER

Grid for Vehicle Identification Number: 4 boxes for Model Number, 17 boxes for Vehicle Identification Number (V.I.N.)

Model Number

Vehicle Identification Number (V.I.N.)

OLD ADDRESS
OR PREVIOUS OWNER:

NAME

NO.

STREET

APT

CITY

STATE/PROVINCE

ZIP/POSTAL CODE

COUNTRY

TELEPHONE

NEW ADDRESS
OR NEW OWNER:

NAME

NO.

STREET

APT

CITY

STATE/PROVINCE

ZIP/POSTAL CODE

COUNTRY

TELEPHONE

E-MAIL ADDRESS

V00A2F

CHANGE OF ADDRESS

CHANGE OF OWNERSHIP



VEHICLE IDENTIFICATION NUMBER

Grid for Vehicle Identification Number: 4 boxes for Model Number, 17 boxes for Vehicle Identification Number (V.I.N.)

Model Number

Vehicle Identification Number (V.I.N.)

OLD ADDRESS
OR PREVIOUS OWNER:

NAME

NO.

STREET

APT

CITY

STATE/PROVINCE

ZIP/POSTAL CODE

COUNTRY

TELEPHONE

NEW ADDRESS
OR NEW OWNER:

NAME

NO.

STREET

APT

CITY

STATE/PROVINCE

ZIP/POSTAL CODE

COUNTRY

TELEPHONE

E-MAIL ADDRESS

V00A2F

***This page is
intentionally blank***

CHANGE OF ADDRESS CHANGE OF OWNERSHIP 

VEHICLE IDENTIFICATION NUMBER

--	--	--	--	--	--	--	--	--	--	--	--	--	--	--	--	--	--	--	--	--

Model Number Vehicle Identification Number (V.I.N.)

OLD ADDRESS OR PREVIOUS OWNER:

NAME _____

NO. _____ STREET _____ APT _____

CITY _____ STATE/PROVINCE _____ ZIP/POSTAL CODE _____

COUNTRY _____ TELEPHONE _____

NEW ADDRESS OR NEW OWNER:

NAME _____

NO. _____ STREET _____ APT _____

CITY _____ STATE/PROVINCE _____ ZIP/POSTAL CODE _____

COUNTRY _____ TELEPHONE _____

E-MAIL ADDRESS _____

V00A2F

CHANGE OF ADDRESS CHANGE OF OWNERSHIP 

VEHICLE IDENTIFICATION NUMBER

--	--	--	--	--	--	--	--	--	--	--	--	--	--	--	--	--	--	--	--	--

Model Number Vehicle Identification Number (V.I.N.)

OLD ADDRESS OR PREVIOUS OWNER:

NAME _____

NO. _____ STREET _____ APT _____

CITY _____ STATE/PROVINCE _____ ZIP/POSTAL CODE _____

COUNTRY _____ TELEPHONE _____

NEW ADDRESS OR NEW OWNER:

NAME _____

NO. _____ STREET _____ APT _____

CITY _____ STATE/PROVINCE _____ ZIP/POSTAL CODE _____

COUNTRY _____ TELEPHONE _____

E-MAIL ADDRESS _____

V00A2F

***This page is
intentionally blank***

NOTES

⚠ WARNING

THIS VEHICLE CAN BE HAZARDOUS TO OPERATE.

A collision or rollover can occur quickly, even during routine maneuvers such as turning and driving on hills or over obstacles, if you fail to take proper precautions.

SEVERE INJURY OR DEATH

can result if you do not follow these instructions:

- **BEFORE YOU OPERATE THIS VEHICLE, READ THIS OPERATOR'S GUIDE, ALL ON PRODUCT SAFETY LABELS AND WATCH THE SAFETY VIDEO.**



- **NEVER OPERATE THIS VEHICLE WITHOUT PROPER INSTRUCTIONS.**
Complete a certified training course.
- **DO NOT EXCEED VEHICLE SEATING CAPACITY**
- **FOR 1UP MODELS, NEVER CARRY A PASSENGER.**
You increase your risk of losing control if you carry a passenger.

- **NEVER OPERATE THIS VEHICLE ON A PAVED SURFACE.**

You increase your risk of losing control if you operate this vehicle on pavement.

- **NEVER OPERATE THIS VEHICLE ON PUBLIC ROADS.**

You can collide with another vehicle if you operate this vehicle on a public road.

- **OPERATOR SHOULD ALWAYS WEAR AN APPROVED HELMET,** eye protection and protective clothing.

- **NEVER USE WITH DRUGS OR ALCOHOL.**

They slow reaction time and impair judgment.

- **NEVER OPERATE THIS VEHICLE AT EXCESSIVE SPEEDS.**

You increase your risk of losing control if you operate this vehicle at speeds too fast for the terrain, visibility conditions, or your experience.

- **NEVER ATTEMPT WHEELIES, JUMPS, OR OTHER STUNTS.**

