

EVEREST[®]

500

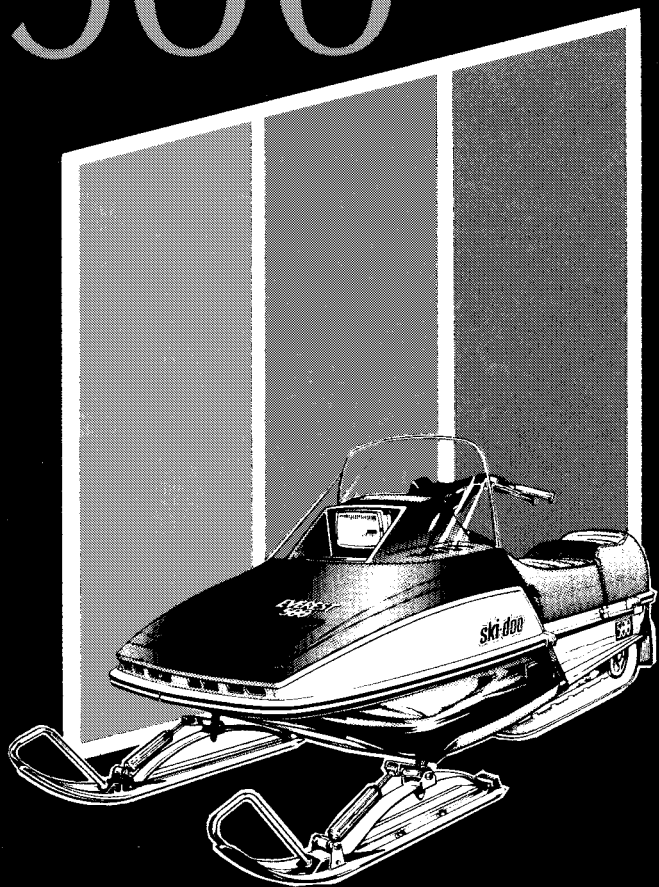

1981 OPERATOR'S MANUAL



[®] *Trademarks of Bombardier Limitée

model _____

V.I.N. _____

purchase date _____

warranty expiry date _____

To be completed by dealer at time of sale

DEALER IMPRINT AREA

TECHNICAL PUBLICATION
AFTER SALES SERVICE
BOMBARDIER LIMITÉE
VALCOURT, QUEBEC
CANADA, J02 2L0

The following are trademarks of Bombardier Limitée.

BOMBARDIER	EVEREST	MOTO-SKI
SKI-DOO	CITATION	FUTURA
ALPINE	OLYMPIQUE	SPIRIT
BLIZZARD	T'NT	NUVIK
CARRY-BOOSE		MIRAGE
ELAN		SUPER SONIC
ELITE		ULTRA SONIC
GRAND PRIX SPECIAL		

INDEX

THE 1981 LIMITED WARRANTY	2
FOREWORD	4
SAFETY IN MAINTENANCE	5
CONTROL/INSTRUMENTS Throttle lever, brake lever, ignition/light switch, headlamp dimmer switch, emergency cut-out switch, manual starter handle, primer, speedometer, tether cut-out switch, adjustable steering handle, light switch, oil level indicator, hood opening, tool box, fuel gauge	6
BREAK-IN PERIOD Break-in, inspection, inspection checklist	8
FUEL Recommended gasoline, recommended injection oil	10
PRE-START CHECK Check points	10
STARTING PROCEDURE Manual starting	11
EMERGENCY STARTING	11
DRIVE BELT AND GUARD REMOVAL	12
LUBRICATION Frequency, steering mechanism, chaincase oil level, oil injection system	13
MAINTENANCE Maintenance chart, spark plugs, battery, suspension, track, track tension and alignment, carburetor, drive belt, steering mechanism, drive pulley, brake, steer- ing adjustment, engine head nuts, engine mount nuts, muffler attachment, fan belt, general inspection, bulb replacement	14
STORAGE Track, suspension, ski assembly, controls, chaincase, fuel tank, carburetor, cylinder lubrication, chassis, general inspection	20
PRE-SEASON PREPARATION Pre-season preparation, chart,	22
TROUBLE SHOOTING	23
TOOLS	25
SPECIFICATIONS	26
WIRING DIAGRAM	27
SI METRIC INFORMATION GUIDE	29
OFTEN ASKED QUESTIONS	30
LISTING OF AREA DISTRIBUTORS	32
HOW TO IDENTIFY YOUR SNOWMOBILE	33
CHANGE OF ADDRESS OR OWNERSHIP	35

LIMITED WARRANTY 1981 SKI-DOO® SNOWMOBILES

1 - PERIOD

BOMBARDIER Limitée as manufacturer, warrants FROM THE DATE OF FIRST CONSUMER SALES, every 1981 Ski-Doo® snowmobile, sold as NEW AND UNUSED, by an authorized Ski-Doo dealer, for periods of:

- 12 months for ELAN® , CITATION* , EVEREST® , ELITE® , ALPINE® models.
- 90 consecutive days for BLIZZARD® 5500, 7500, 9500 models subjects to the following:
 1. If delivery is made after the 31st day of March of a given year and before the 1st day of December of the same year, the above 90 day warranty will start on December 1st.
 2. If delivery is made on/or after the 2nd day of January of a given year but before the 31st day of March of the same year, all the unused portion of the 90 day period will be carried over to the next winter and start again on the 1st day of December of the same year.

2 - WHAT BOMBARDIER WILL DO

BOMBARDIER will repair and/or replace, at its option, components defective in material and/or workmanship (under normal use and service,) with a genuine BOMBARDIER component without charge for parts or labour, at any authorized Ski-Doo dealer during said warranty period.

3 - CONDITION TO HAVE WARRANTY WORK PERFORMED

Present to the servicing dealer, the hard copy of the BOMBARDIER Customer Registration card received by the customer from the selling dealer at time of purchase.

4 - WARRANTY TRANSFER

This warranty is transferable to subsequent owner(s) for remainder of warranty period from original date of sale.

5 - EXCLUSIONS - ARE NOT WARRANTED

- Normal wear on all items such as, but not limited to:
 - drive belts
 - slider shoes
 - spark plugs
 - breaker points
 - runners on skis
- A sulphated battery.
- Replacement parts and/or accessories which are not genuine Bombardier parts and/or accessories.
- Damage resulting from installation of parts other than genuine BOMBARDIER parts.
- Damage caused by failure to provide proper maintenance as detailed in the Operator Manual. The labour, parts and lubricants costs of all maintenance services, including tune-ups and adjustments will be charged to the owner.

- Vehicles used for racing purposes.
- All optional accessories installed on the vehicle.
(The normal warranty policy for parts and accessories, if any, applies).
- Damage resulting from accident, fire or other casualty, misuse, abuse or neglect.
- Damage resulting from modification to the snowmobile not approved in writing by BOMBARDIER.
- **Losses incurred by the snowmobile owner other than parts and labour, such as, but not limited to, transportation, towing, telephone calls, taxis, or any other incidental or consequential damages.**

Some states or provinces do not allow the exclusion or limitation of incidental or consequential damages, so the above limitation or exclusion may not apply.

6 - EXPRESSED OR IMPLIED WARRANTIES

This warranty gives you specific rights, and you may also have other legal rights which may vary from state to state, or province to province. Where applicable this warranty is expressly in lieu of all other expressed or implied warranties of BOMBARDIER, its distributors and the selling dealer, including any warranty of merchantability of fitness for any particular purpose; otherwise the implied warranty is limited to the duration of this warranty. However, some states or provinces do not allow limitations on how long an implied warranty lasts, so the above limitation may not apply.

Neither the distributor, the selling dealer, nor any other person has been authorized to make any affirmation, representation or warranty other than those contained in this warranty, and if made, such affirmation, representation or warranty shall not be enforceable against BOMBARDIER or any other person.

7 - CONSUMER ASSISTANCE

If a servicing problem or other difficulty occurs, we suggest the following:

1. Try to resolve the problem at the dealership with the Service Manager or Owner.
2. If this fails, contact your area distributor listed in the Operator Manual.
3. Then if your grievance still remains unsolved, you may write to us:

BOMBARDIER LIMITÉE
Customer Relations
Recreational Products
Valcourt, Quebec, Canada, JOE 2LO

BOMBARDIER LIMITÉE RESERVES THE RIGHT TO MODIFY ITS WARRANTY POLICY AT ANY TIME, BEING UNDERSTOOD THAT SUCH MODIFICATION WILL NOT ALTER THE WARRANTY CONDITIONS APPLICABLE TO VEHICLES SOLD WHILE THE ABOVE WARRANTY IS IN EFFECT.

October 1979
Bombardier Limitée
Valcourt, Quebec, Canada, JOE 2LO

© *Trademarks of Bombardier Limitée

FOREWORD

The operator manual and the Snowmobile Safety handbook have been prepared to acquaint the owner / operator of a new snowmobile with the various vehicle controls, maintenance and safe operating instructions. Each is indispensable for the proper use of the product, and should be kept with the vehicle at all times.

Should you have any questions pertaining to the warranty and its application, please consult the "Often Asked Question" section of this manual, or your selling dealer.

This manual uses the following symbols.

 **WARNING:** Identifies an instruction which, if not followed, could cause personal injury.

 **CAUTION:** Denotes an instruction which, if not followed, could severely damage vehicle components.

 **NOTE:** Indicates supplementary information needed to fully complete an instruction.

Although the mere reading of such information does not eliminate the hazard, your understanding of the information will promote its correct use.

SAFETY IN MAINTENANCE

Observe the following precautions:

- Throttle mechanism should be checked for free movement before starting engine.
- Engine should be running only when pulley guard is secured in place.
- Never run engine without drive belt installed. Running an unloaded engine can prove to be dangerous.
- Never run engine when the track of the vehicle is raised off the ground.
- It can be dangerous to run engine with the cab removed.
- Gasoline is flammable and explosive under certain conditions. Always manipulate in a well ventilated area. Do not smoke or allow open flames or sparks in the vicinity. If gasoline fumes are noticed while driving, the cause should be determined and corrected without delay.
- Maintain your vehicle in top mechanical condition at all times.
- Your snowmobile is not designed to be driven or operated on black top, bare earth, or other abrasive surfaces. On such surfaces abnormal and excessive wear of critical parts is inevitable.
- Installation of other than standard equipment, including ski-spreaders, bumpers, pack racks, etc., could severely affect the stability and safety of your vehicle. Avoid adding on accessories that alter the basic vehicle configuration.
- **The snowmobile engine can be stopped by activating the emergency cut-out switch, tether switch or by turning off the key.**
- Whenever the vehicle is parked outdoors, overnight or for a long period, it is suggested to protect it against the inclemency of the weather with a snowmobile cover.
- Do not lubricate throttle and/or brake cables and housings.

Please read and understand all other warnings contained elsewhere.

THIS MANUAL SHOULD REMAIN WITH THE VEHICLE AT THE TIME OF RESALE.

CONTROLS/INSTRUMENTS

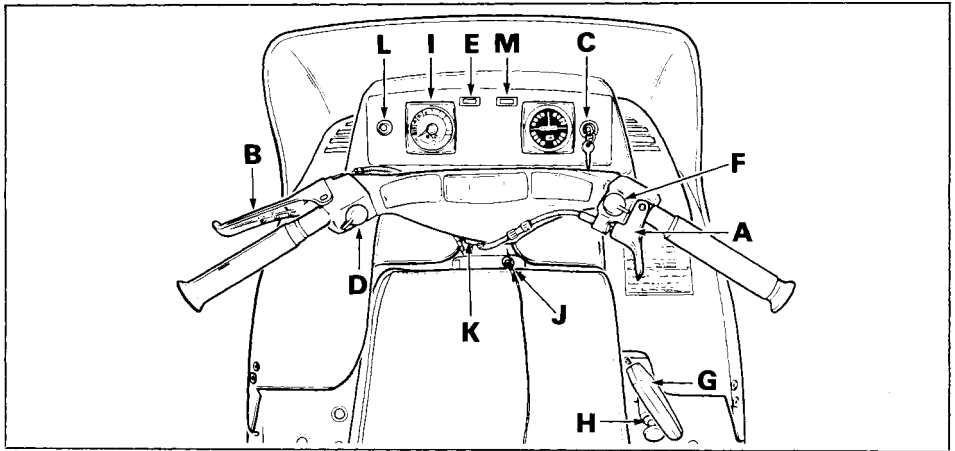

- A) Throttle Control Lever
- B) Brake Control Lever
- C) Ignition/Light Switch
- D) Headlamp Dimmer Switch
- E) High Beam Indicator
- F) Emergency Cut-Out Switch
- G) Manual Starter Handle
- H) Primer
- I) Speedometer
- J) Tether Cut-Out Switch
- K) Adjustable steering handle
- L) Light switch (Electric Model)
- M) Oil Level Indicator

A) Throttle Lever

Located on right side of handlebar. When compressed, it controls the **engine speed** and the **engagement of the transmission**. When released, engine speed returns automatically to idle.

B) Brake Control Lever

Located on the left side of handlebar. When compressed, the brake is applied. When released, it automatically returns to its original position. Braking effect is proportionate to the pressure applied on the lever.

NOTE: On electric start models only, compressing the brake lever will light up the oil level indicator bulb. If bulb does not light up, replace with a new one.

C) Ignition/Light Switch (Manual Start Models)

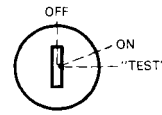

Key operated, 3 position switch. To start engine, first turn key clockwise to ON position. **To stop engine**, turn key counter-clockwise to OFF position.

The lights are automatically ON whenever the engine is running.

To test oil level indicator bulb, with engine running, turn key to test position. If bulb does not lite, replace.

(Electric Start Models)

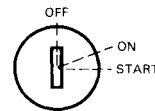

Key operated, 3 position switch. To start engine, turn key fully clockwise to START position and hold. Return key to ON position **immediately** when engine has started. **To stop engine**, turn key counter-clockwise to OFF position.

D) Headlamp Dimmer Switch

Located on left side of handlebar, flick switch to high or low beam.

E) High Beam Indicator

Lights up when headlamp is on high beam.

F) Emergency Cut-Out Switch

A 3 position switch located on the right side of the handlebar. To stop the engine in an emergency, flick the lever to either upper or lower "OFF" position. To start engine, lever must be in middle "ON" position.

The driver of this vehicle should familiarize himself with the function of this device by using it several times on first outing, thereby being mentally prepared for emergency situations requiring its use.

◆ **WARNING:** If the switch has been used in an emergency situation the source of malfunction should be determined and corrected before re-starting the engine.

G) Manual Starter Handle

Auto rewind type located on right hand side of vehicle. To engage mechanism, pull handle.

H) Primer

A push-pull button. Pull and push button (2-3 times) to activate primer. The primer should always be used for cold engine starts. After engine is warm however, it is not necessary to use primer when starting.

I) Speedometer

The speedometer is linked directly to the drive axle. Direct-reading dial indicates the speed of the vehicle. Odometer records the total number of distance travelled.

J) Tether Cut-Out Switch

Attach tether cord to wrist or other convenient location then snap tether cut-out cap over receptacle before starting engine.

If emergency engine "shut-off" is required completely pull cap from safety switch and engine power will be automatically shut "off".

○ **NOTE:** The cap must be installed on the safety switch at all times in order to operate the vehicle.

◆ **WARNING:** If the switch is used in an emergency situation the source of malfunction should be determined and corrected before restarting engine.

K) Adjustable steering handle

- Loosen the four retainer screws.
- Adjust the steering handle to the desired position.
- Lock the steering handle in place by tightening the four (4) screws to 26 N•m (19 ft-lbs).

◆ **WARNING:** Do not adjust the handlebar to high to avoid interference when turning, between the brake lever and windshield.

L) Light Switch

A push pull switch type, to illuminate headlamp and taillight, pull switch knob. (Ignition switch must be turned to ON position).

M) Oil Level Indicator

Will light up when injection oil level is low. Check level and replenish as soon as possible.

▼ **CAUTION:** Do not run engine out of oil. Serious engine damage will occur.

To test oil level indicator bulb: on manual start models, turn ignition key (engine running) to "test" position. On electric start models, indicator light will glow each time brake lever is used. If light does not glow, replace bulb.

Hood Opening

Pull down the latch to unhook the hood from the anchor.

○ **NOTE:** Always lift hood gently up until stopped by restraining device.

◆ **WARNING:** It is dangerous to run an engine with the hood open or removed. Personal injury could result.

▼ **CAUTION:** Prior to re-securing the hood latch, position the bottom edge of the hood into the hood guide located on each side of the frame.

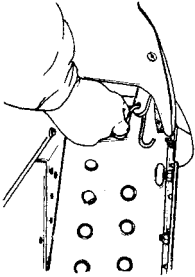

Tool Box

Located under the hood. To gain access, tilt hood. Ideal location for spare plugs, belt, rope, etc.

Fuel Gauge

The fuel gauge is located on the left side of the fuel tank. The gauge functions on the principle of communicating vessels, so the fuel level inside the tank is directly related with the level indicated on the gauge.

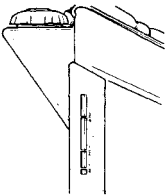

◆ **WARNING:** Never use a lite match or open flame to check fuel level.

With Bombardier-Rotax snowmobile engines, a break-in period is required before running the vehicle at full throttle. Engine's manufacturer recommendation is 10 to 15 operating hours. During this period, a richer mixture is needed (i.e. 40 parts of gas for 1 part of 50/1 Bombardier oil). Maximum throttle should not exceed $\frac{3}{4}$, however, brief full acceleration and speed variations contribute to a good break-in. Continued wide open throttle accelerations, prolonged cruising speeds, and lugging are detrimental during the break-in period.

○ **NOTE:** A new drive belt requires a break-in period of 15-25 km (10-15 miles).

10-Hour Inspection

As with any precision piece of mechanical equipment, we suggest that after the first 10 hours of operation or 30 days after the purchase, whichever comes first, your vehicle be checked by your dealer. This inspection will give you the opportunity to discuss the unanswered questions you may have encountered during the first hours of operation. Remember that it is easier to remedy at this time than to allow the snowmobile to operate until a possible failure occurs.

The 10 hours inspection is at the expense of the vehicle owner.



10-HOUR INSPECTION CHECK LIST	
Engine timing	
Fan belt tension	
Spark plugs condition	
Carburetor adjustment	
Oil injection pump adjustment	
Engine head nuts	
Engine mount nuts	
Muffler attachment	
Chaincase oil level	
Brake operation and lining condition	
Ski alignment (runner condition)	
Pulley alignment and drive belt condition	
Track condition, tension and alignment	
Lubrication (steering, suspension)	
Electrical wiring (loose connections, stripped wires, damaged insulation), tighten all loose bolts, nuts and linkage	
Operation of lighting system (HI / LO beam, brake light, etc.), test-operation of emergency cut-out switch, tether switch	

We recommend that you have your dealer sign this inspection .

Date of 10 hour inspection

Dealer signature

Recommended Gasoline

Use regular leaded gasoline available from all service stations.

▼ **CAUTION:** Never experiment with different fuel or fuel ratios. Never use naphtha, methanol or similar products.

○ **NOTE:** For the break-in period only, 1 (16 oz) can of Bombardier snowmobile oil should be added to the first full fuel tank filling, at a 70/1 ratio. This will assure additional protection during the initial engine break-in.

◆ **WARNING:** Never “top up” the gas tank before placing the vehicle in a warm area. At certain temperatures, gasoline will expand and overflow.

Recommended Injection Oil

Use concentrated Bombardier snowmobile oil available from your dealer.

Check Points

- Activate the throttle control lever several times to check that it operates easily and smoothly. The throttle control lever must return to idle position when released.
 - Check fuel level.
 - Check that the skis and the track are not frozen to the ground or snow surface and that the steering operates freely.
 - Activate the brake control lever and make sure the brake fully applies before the brake control lever touches the handlebar grip.
 - Verify that the path ahead of the vehicle is clear of bystanders and obstacles.
- ◆ **WARNING:** Only start your snowmobile once all components are checked and functioning properly.

STARTING PROCEDURE

Emergency Cut-Out Switch

Manual Starting

1. Insert the key in the ignition and turn to ON position.
2. Test the throttle control lever.
3. Activate the primer (2 to 3 times).

○ **NOTE:** Primer is not necessary when the engine is warm.

4. Ensure the tether cut-out cap is in position and that the cord is attached to your clothing. Check that the emergency cut-out switch is in the on position.
5. Grasp manual starter handle firmly and pull slowly until a resistance is felt then pull vigorously. Slowly release the rewind starter handle.

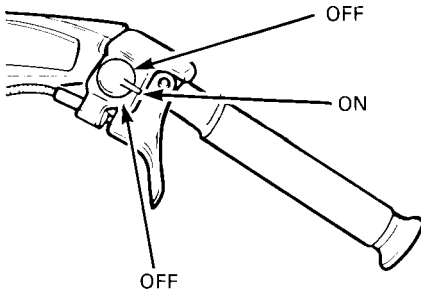

◆ **WARNING:** Do not apply throttle while starting.

6. Check operation of the emergency cut-out switch, and the tether switch. Restart the engine.

◆ **WARNING:** If engine does not shut-off when applying the emergency cut-out switch and/or by pulling the tether cut-out cap, stop the engine by turning off the ignition key. Do not operate the vehicle further, see your dealer.

7. Allow the engine to warm before operating at full throttle.

Emergency Starting

Should the rewind starter rope fray and break, the engine can be started with an emergency starter rope.

◆ **WARNING:** Do not start the vehicle by the drive pulley unless it is a true emergency situation, have the vehicle repaired as soon as possible.

Remove the belt guard from the vehicle and wind the emergency rope tight around the drive pulley between the sliding half and the roller guard. Start the engine as per usual manual starting.

◆ **WARNING:** When starting the vehicle in an emergency situation by the drive pulley, do not make a knot at the end of the emergency rope and do not reinstall the belt guard.

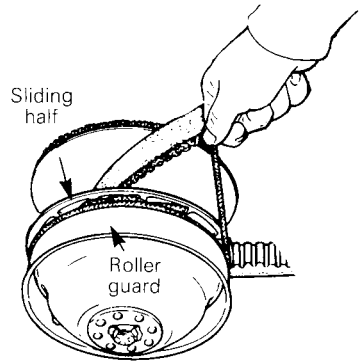

DRIVE BELT AND GUARD REMOVAL

Belt Guard Removal

◆ **WARNING:** Engine should be running only when belt guard is secured in place.

1. Tilt the hood, remove both belt guard retaining clips (A).
2. Pull out both B & C retaining pins.

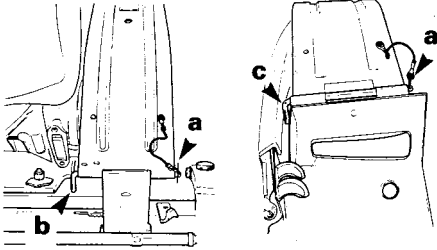

◆ **WARNING:** At the removal or installation of the belt guard front retaining pin be careful not to burn yourself on the exhaust system.

3. Lift and remove the belt guard assembly.

Drive Belt Removal

◆ **WARNING:** Never start or run engine without the drive belt installed. Running an unloaded engine is dangerous.

1. Tilt the hood and remove the belt guard.
2. Open the driven pulley by twisting and pushing the sliding half. Hold in fully open position.

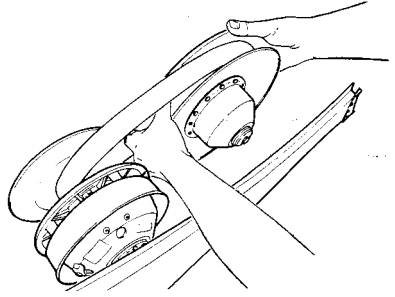

3. Slip the belt over the top edge of the sliding half.

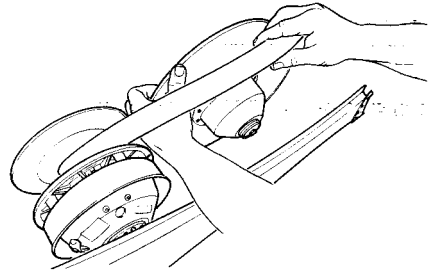

4. Slip the belt out from the drive pulley and remove completely from the vehicle. To install the drive belt, reverse the procedure.

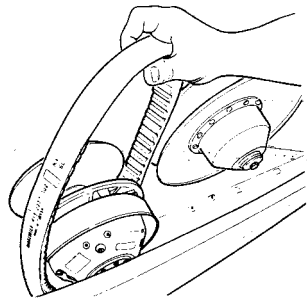

LUBRICATION

Frequency

Routine maintenance is necessary for all mechanized products, and the snowmobile is no exception. A weekly vehicle inspection contributes to the life span of the snowmobile as well as retains safe and dependable operation. It is recommended that the steering system and suspension be lubricated monthly or every 40 hours of operation. If the vehicle is operated in wet snow or in severe conditions these items should be lubricated more frequently.

◆ **WARNING:** Only perform such procedures as detailed in this manual. It is recommended that dealer assistance be periodically obtained on other components/systems not covered in this manual. Unless otherwise specified, engine should be turned OFF for all lubrication and maintenance procedures.

Steering Mechanism

◆ **WARNING:** Do not lubricate throttle and/or brake cables and housings.

Lubricate the ski legs at grease fittings until new grease appears at joints. Oil spring coupler bolts.

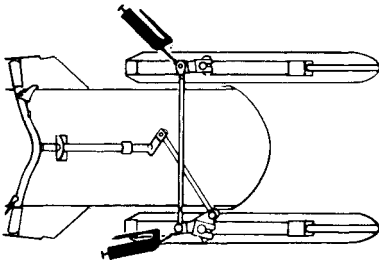

Chaincase Oil Level

Check the oil level by removing the oil level cap plug.

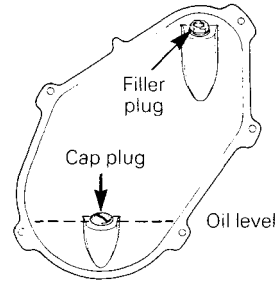

The oil should be level with the bottom of the oil level orifice.

○ **NOTE:** The chaincase oil capacity is approximately 200 mL (7 oz).

Oil Injection System

Check reservoir frequently. Replenish as required, using Bombardier snowmobile oil, available from your dealer.

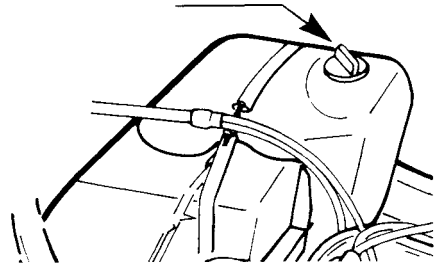

MAINTENANCE

The following Maintenance Chart indicates regular servicing schedules to be performed by you or your servicing dealer. If these services are performed as suggested, your snowmobile will give you many years of low-cost use.

WARNING: Only perform such procedures as detailed in this manual. It is recommended that dealer assistance be periodically obtained on other components/systems not covered in this manual. Unless otherwise specified, engine should be turned OFF for all lubrication and maintenance procedures.

SERVICE AND MAINTENANCE CHART	Weekly or every 240 km (150 m)	Monthly or every 800 km (500 m)	Once a year or every 3200 km (2000 m)	Refer to page
Spark plugs		●		15
Battery		●		15
Suspension		●		15
Track		●		15
Track tension and alignment		●		16
Carburetor adjustment			●	17
Drive belt	●			17
Steering mechanism		●		17
Drive pulley		●		18
Brake	●			18
Steering adjustment		●		18
Engine head nuts			●	19
Engine mount nuts			●	19
Muffler attachment		●		19
Fan belt			●	19
General inspection		●		19

○ **NOTE:** The ten hour inspection is a very important part of proper service and maintenance.

Spark Plugs

Disconnect the spark plug wires and remove the spark plugs.

Check the condition of the plugs.

- A brownish tip reflects ideal conditions. (Correct carburetor, spark plug heat range; etc.).
- A black insulator tip indicates fouling caused by: carburetor idle speed mixture and/or high speed mixture too rich, incorrect fuel mixture ratio, wrong type of spark plug (heat range), or excessive idling.
- A light grey insulator tip indicates a lean mixture caused by; carburetor high speed mixture adjusted too lean, wrong spark plug heat range, incorrect fuel mixture ratio, or a leaking seal or gasket.

Overheated
(light grey)

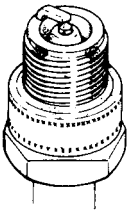

Normal
(brownish)

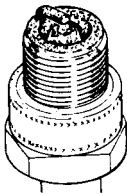

Fouled
(black)

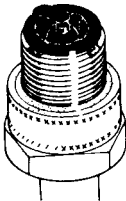

CAUTION: If spark plug condition is not ideal, contact your authorized dealer.

Check spark plug gap using a wire feeler gauge.

Reinstall plugs and connect wires.

Battery (Electric Start Models)

Check electrolyte level. Electrolyte level must be at upper level line on battery casing.

If necessary add distilled water. Battery connections must also be free of corrosion. If cleaning is necessary remove corrosion using a stiff brush then clean with a solution of baking soda and water. Rinse and dry well.

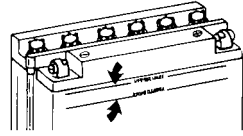

CAUTION: Do not allow cleaning solution to enter battery. It will destroy the chemical properties of the electrolyte.

After reconnecting battery coat battery terminals and connectors with petroleum jelly to prevent corrosion. Check that battery is well secured and that battery overflow tube is not blocked or kinked.

WARNING: Overflow tube must be free and open. A kinked or bent tube will restrict ventilation and create gas accumulation that could result in an explosion. Avoid skin contact with electrolyte.

CAUTION: Prior to charging the battery, always remove it from the vehicle to prevent electrolyte spillage.

Suspension

Visually inspect all suspension components including slider shoes, springs, wheels, etc...

NOTE: During normal driving, snow will act as a lubricant and coolant for the slider shoes. Extensive riding on ice or sanded snow, (not to mention dirt, asphalt, etc. never recommended) will create excessive heat build-up and cause premature slider shoe wear.

Track

Lift the rear of the vehicle and support it off the ground. With the engine off, rotate the track by hand, and inspect condition. If worn, cut or track fibers are exposed or missing or defective inserts or guides are noted, contact your dealer.

WARNING: Do not operate a snowmobile with a cut, torn or damaged track.

Track Tension and Alignment

The suspension is adjustable. The front adjustment for surface condition; use the suspension adjustment key. The rear adjustment is for driver's weight and should be adjusted using the 21 mm socket and handle.

When the front adjuster blocks are at the lowest elevation more weight is distributed on the skis. At the highest position the weight is transferred to the track. The rear adjuster blocks should be adjusted to suit the driver's preference.

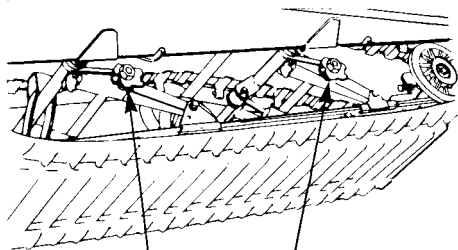

Adjuster blocks

CAUTION: Always turn the left side adjuster blocks in a clockwise direction, the right side blocks in a counter-clockwise direction. Left and right adjuster blocks of each adjustment must always be set at the same elevation.

Lift the rear of vehicle and support with a mechanical stand. Allow the slide to extend normally. Check the gap 13 mm (1/2") between the slider shoe and the bottom inside of the track. If the track tension is too loose, the track will have a tendency to thump.

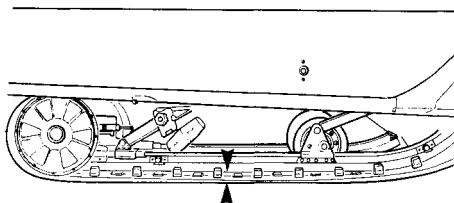

13 mm (1/2")

CAUTION: Too much tension will result in power loss and excessive stresses on suspension components.

If necessary to adjust, loosen the rear idler wheel retaining screw and then loosen or tighten the adjuster bolts located on the inner side of the rear idler wheels. If correct tension is unattainable. Contact your dealer.

NOTE: Track tension and alignment are inter-related. Do not adjust one without the other.

Start the engine and accelerate slightly so that the track turns slowly. Check that the track is well centered; equal distance on both sides between edges of track guides and slider shoes.

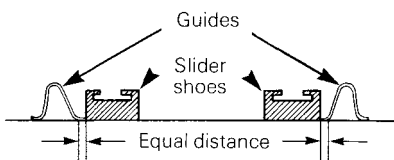
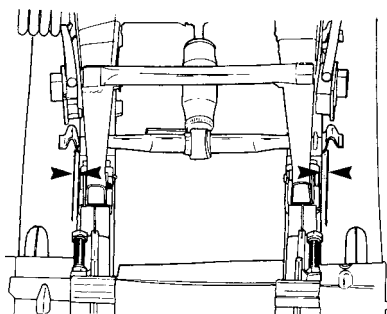

WARNING: Before checking track alignment, ensure that the track is free of all particles which could be thrown out while track is rotating. Keep hands, tools, feet and clothing clear of track. Ensure no-one is standing in close proximity to the vehicle.

To correct, stop the engine, loosen the rear idler wheels retaining screws then loosen the lock nuts and tighten the adjuster bolt on the side where the slider shoe is the furthest to the track insert guides.

Tighten the lock nuts and recheck the alignment. Ensure to retighten the idler wheel retaining screws.

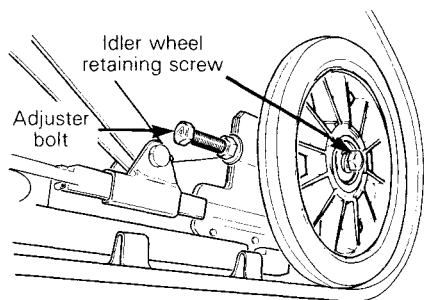

Carburetor Adjustment

CAUTION: Never operate your snowmobile with the air intake silencer disconnected. Serious engine damage will occur if this notice is disregarded.

Carburetor adjustment should be performed by your dealer.

Air Silencer

The air intake silencer elbow must always be turned to the front of the vehicle when operated in cold or warm temperature.

If the vehicle is to be operated in deep powdered snow it is recommended to turn the elbow towards the rear of the vehicle.

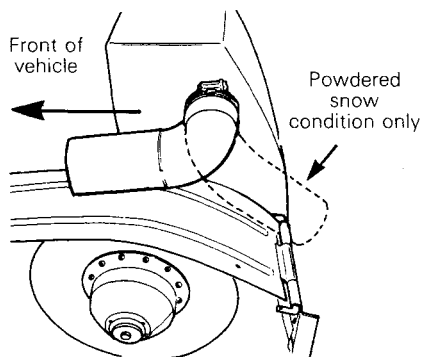

Drive Belt

Inspect the belt for cracks, fraying or abnormal wear (uneven wear, wear on one side, etc.) If abnormal wear is noted, probable cause is pulley misalignment. Contact your dealer.

Check the drive belt width, if less than 3 cm (1 3/16") replace.

NOTE: When installing a new drive belt, a break-in period of 15-25 km (10-15 miles) is strongly recommended.

Steering Mechanism

Inspect the steering mechanism for tightness of components (steering arms, tie rods, ball joints, spring coupler bolts, etc.). If necessary, replace or retighten.

Check the condition of the skis and the ski runners. Replace if worn more than half.

Drive Pulley

Inspect the Duralon bushing condition by checking the free-play of the sliding half pulley. This is achieved by restraining the inner half and checking if the sliding half moves in the direction of the arrows more than 3 mm (1/8"). If so contact your dealer.

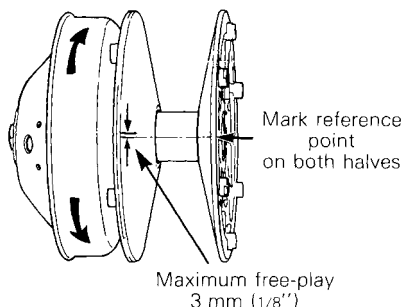

Brake

The brake mechanism on your snowmobile is an essential safety device. Keep this mechanism in proper working condition. Above all, do not operate your snowmobile without an effective brake system.

◆ **WARNING:** Brake pad or pucks less than 3 mm (1/8") thick must be replaced. Replacement must be performed by an authorized dealer.

The brake mechanism is self-adjusting, therefore, periodic adjustment is not required. However, check operation of brake mechanism by depressing brake control lever. Brake should apply fully when lever is 13 mm (1/2") approx. from handlebar grip. If not, do not tamper with the brake, contact your servicing dealer.

Steering Adjustment

Skis should have a toe out of 3 mm (1/8"). To check, measure the distance between each ski at the front and rear of the leaf springs. The front distance should be 3 mm (1/8") more than the rear when the handlebar is horizontal.

IMPORTANT: Close the front of the skis manually to eliminate all slack from the steering mechanism.

If adjustment is required:

Loosen the lock nuts of the longer tie rod. Turn the tie rod manually until the skis are properly aligned. Firmly retighten the lock nuts.

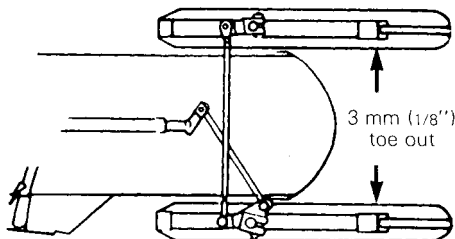

The handlebar should also be horizontal when the skis are pointed toward the front.

To adjust:

Loosen the lock nuts of the shorter tie rod. Turn the tie rod manually until the handlebar is horizontal. Retighten the lock nuts firmly.

◆ **WARNING:** The ball joint socket must run parallel with the steering arm. The socket must be restrained when tightening the tie rod end lock nuts.

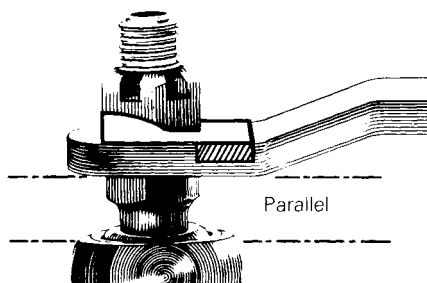

Engine Head Nuts

With the engine cold, check that the engine head nuts are tight and equally torqued to 20 N•m (15 ft-lbs).

IMPORTANT: The engine head nut torque should be checked after the first 5 hours of operation.

Engine Mount Nuts

Check the engine mount nuts for tightness. Retighten if necessary.

Muffler Attachment

The engine/muffler attaching parts are vital toward efficient muffler function. Check all attachments. Replace the springs and/or tighten if necessary.

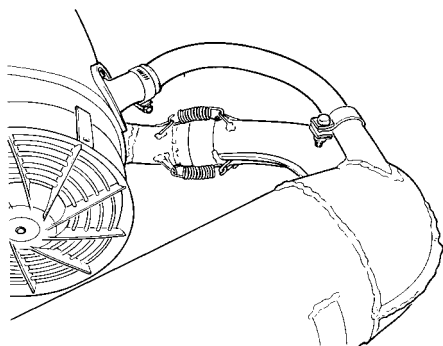

Ensure that the forced flow system is well aligned and tightened.

Fan Belt

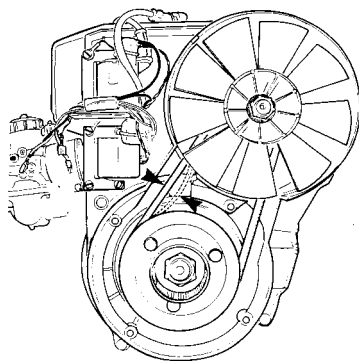

If the belt seems damaged or if tension is incorrect, contact your dealer immediately.

WARNING: If fan protector is removed, always reinstall after servicing.

General Inspection

Check the electrical wiring and components, retighten loose connections. Check for stripped wires or damaged insulation. Thoroughly inspect the vehicle and tighten loose bolts, nuts and linkage. Inspect skis and ski runners for wear.

Bulb Replacement

If the headlamp bulb is burnt, tilt cab, unplug the connector from the headlamp. Remove the rubber boot and unfasten bulb retainer clips. Detach the bulb and replace. If taillight bulb is burnt, expose the bulb by removing the red plastic lens. To remove, unscrew the two (2) Phillips head screws. Verify all lights after replacement.

STORAGE

◆ **WARNING:** Only perform such procedures as detailed in this manual. It is recommended that dealer assistance be periodically obtained on other components/systems not covered in this manual. Unless otherwise specified, engine should be turned OFF for all lubrication and maintenance procedures.

Track

Inspect the track for wear, cuts, missing track guides and broken rods. Make any necessary replacement.

◆ **WARNING:** Do not operate a snowmobile with a cut, torn or damage track.

Lift the rear of vehicle until track is clear of the ground then support with a brace or trestle. The snowmobile should be stored in such a way that the track does not stay in contact with the ground.

○ **NOTE:** The track should be rotated periodically, (every 40 days). Do not release track tension.

▼ **CAUTION:** To prevent track damage, temperature in the storage area must not exceed 38°C (100°F).

Slide Suspension

Remove any dirt or rust. Grease idler wheels at grease fittings. Wipe off surplus. Replace worn slider shoes. Grease front idler wheels.

Ski

Wash or brush all dirt or rust accumulation from the skis and springs. Grease the ski legs at the grease fittings. Check the condition of the skis, ski runners and leaf springs. Replace if weak or worn more than half.

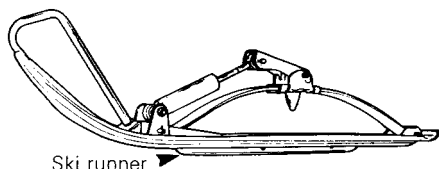

Controls

Lubricate the steering mechanism. Inspect all components for tightness, (spring coupler bolts, steering arm locking bolts, tie rods, ball joints, etc.). Tighten if necessary. Oil moving joints of the brake mechanism.

◆ **WARNING:** Do not lubricate the throttle and/or brake cables and housings. Avoid getting oil on the brake pads.

Coat all electrical connections and switches with a greaseless metal protector. If unavailable, use petroleum jelly.

Chaincase

Drain the chaincase and refill to proper level, using fresh chaincase oil. To drain, remove the chaincase cover.

Fuel Tank

Remove the cap then using a syphon, remove the gasoline from tank.

◆ **WARNING:** Gasoline is flammable and explosive under certain conditions. Always perform procedures in a well ventilated area. Do not smoke or allow open flames or sparks in the vicinity.

Carburetor

Carburetors must be dried out completely to prevent gum formation during the storage period.

Once the fuel tank is emptied, remove the float chamber drain plug on each carburetor. Drain carburetor.

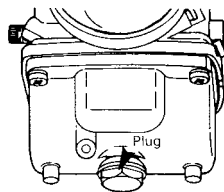

Re-install plug and connect fuel line. Check all fuel lines, replace if necessary.

Cylinder Lubrication

Engine internal parts must be lubricated to protect cylinder walls from possible rust formation during the storage period.

○ **NOTE:** This operation should be repeated every 40 days during storage.

Remove the spark plugs. Operate the rewind starter to bring the piston at top position. Pour the equivalent of one spoonful of oil into spark plug hole.

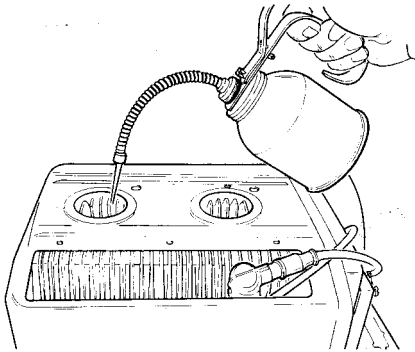

Slowly crank the engine several times using the manual starter. Repeat above steps for other cylinder. Install the spark plugs.

▼ **CAUTION:** To prevent ignition system damage, make sure that the cut-out button is in the lower position.

Chassis

Clean the vehicle thoroughly, removing all dirt and grease accumulation.

▼ **CAUTION:** Plastic alloy components such as fuel tank, windshield, controls, etc., can be cleaned using mild detergents or isopropyl alcohol. Do not use strong soaps, degreasing solvents, abrasive cleaners, paint thinners, etc.

Inspect the hood and repair any damage. Repair kits are available at your authorized dealer. Clean the frame. For the aluminum portion use only "Aluminum cleaner" and follow instructions on the container.

Touch up all metal spots where paint has been scratched off. Spray all bare metal parts with metal protector. Wax the hood for better protection.

○ **NOTE:** Apply wax on glossy finish of hood only. Protect the vehicle with a cover to prevent dust accumulation during storage.

▼ **CAUTION:** If for some reason the snowmobile has to be stored outside it is necessary to cover it with an opaque tarpaulin. This caution will prevent the sun rays affecting the plastic components and the vehicle finish.

General Inspection

Check the electrical wiring and components, retighten loose connections. Check for stripped wires or damaged insulation.

Thoroughly inspect the vehicle and tighten loose bolts, nuts and linkage.

○ **NOTE:** Leave the drive belt off the pulleys for the entire storage period.

PRE-SEASON PREPARATION

To simplify the pre-season preparation we have drawn up a small chart. The chart indicates servicing points to be performed by you and your servicing dealer. If these services are performed as suggested, your vehicle will give you many hours of fun and low cost use.

IMPORTANT: Observe all Warnings and Cautions mentioned throughout this manual which are pertinent to the item being checked. When component conditions seem less than satisfactory, replace with genuine Bombardier parts or suitable equivalents.

PRE-SEASON PREPARATION CHART

To be performed by dealer	●
To be performed by owner	○
Change spark plugs	○
Check chaincase oil level	○
Check pulleys, verify components and clean	●
Check steering alignment and ski runner condition	○
Clean fuel filter (located in fuel tank)	○
Check suspension idler wheel bearings	●
Check track tension and alignment	○
Inspect drive belt and install	○
Check throttle cable for damage and free operation	○
Inspect brake condition and operation	●
Inspect oil seals for possible cuts or leaks	○
Set engine timing, if necessary replace breaker points	●
Check electrical wiring (broken wire, damaged insulation)	○
Inspect condition of starting rope	○
Check tightness of all bolts, nuts and linkage	○
Refill gas tank	○
Adjust carburetor	●
Check fan belt condition and tension	○

TROUBLE SHOOTING

○ **NOTE:** The possible causes have been listed in an order of frequency. Therefore, items should be checked out in the same order as mentioned in the trouble shooting guide.

SYMPTOMS	POSSIBLE CAUSES	WHAT TO DO
Engine turns over but fails to start or starts with difficulty	1. No fuel to the engine	Check the tank level and fill up with correct gas-oil mixture. Check for possible clogging of fuel line, item 4.
	2. Flooded engine	Remove wet spark plugs, turn ignition to OFF and crank engine several times. Install clean dry spark plugs. Start engine following usual starting procedure. If engine continues to flood, see your dealer.
	3. Spark plug/faulty ignition	Check for fouled or defective spark plug. Disconnect spark plug wire, unscrew plug and remove from cylinder head. Reconnect wire and ground exposed plug on engine cowl, being careful to hold away from spark plug hole. Follow engine starting procedure and check for spark. If no sparks appear, replace spark plug. If trouble persists, contact your dealer.
	4. Clogged fuel line (water or dirt)	Remove and clean the fuel filter. Change filter cartridge if necessary. Check condition and connections of fuel lines. Check the cleanliness of fuel tank.
	5. Incorrect carburetor adjustment	Contact your dealer.
	6. Too much oil in fuel	Drain the fuel tank and refill with the correct gas/oil mixture.
	7. Engine timing	Engine timing may be defective or out of adjustment. Contact your dealer.
	8. Poor engine compression	Running with a lean fuel mixture may produce excessive engine wear resulting in poor engine compression. If this occurs, contact your dealer at once.
Engine will not turn manually	1. Seized engine	In the case of a seized engine contact your dealer.

SYMPTOMS	POSSIBLE CAUSES	WHAT TO DO
Engine lacks acceleration or power	1. Fouled or defective spark plug	Check item 3 of "Engine turns over but fails to start or starts with difficulty"
	2. Clogged fuel line (water or dirt)	Check fuel line condition. (See item 4 of "Engine turns over but fails to start or starts with difficulty").
	3. Carburetor	Contact your dealer.
	4. Ignition	First check item 2 and 3 of "Engine turns over but fails to start or starts with difficulty". If the ignition system still seems faulty, contact your dealer.
	5. Engine	If unable to locate specific symptoms, contact your dealer.
Engine continually backfires	1. Spark plug	Check item 3 of "Engine turns over but fails to start or starts with difficulty".
	2. Overheated	Carburetor set too lean. Contact your dealer.
	3. Engine timing incorrectly set	Contact your dealer.
Snowmobile cannot reach full speed	1. Drive Belt	Check for damaged or worn drive belt. Replace if necessary.
	2. Incorrect track adjustment	Check track tension and alignment. Readjust to specifications. (See Maintenance Section).
	3. Engine	Check item 1 to 5 of "Engine lacks acceleration or power."
	4. Pulley misaligned	Contact your dealer.

TOOLS

As standard equipment each new snowmobile is supplied with a basic tool kit such as screwdriver, wrenches, emergency starter rope, etc...

Standard Tools

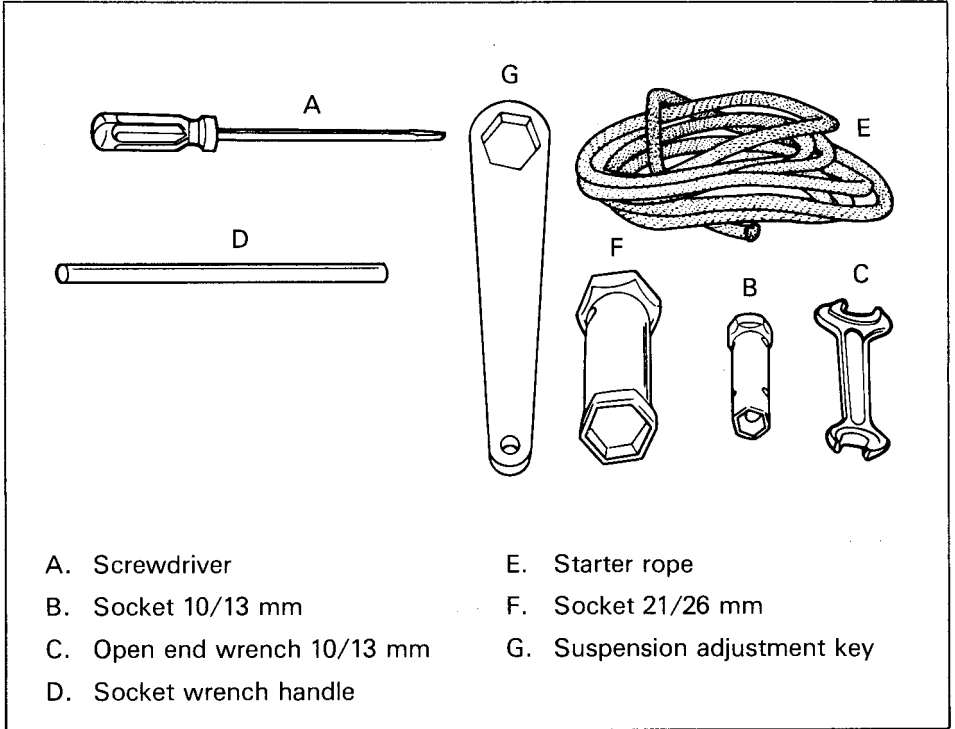

SPECIFICATIONS

1981 EVEREST 500

ENGINE

No. of cylinders	2
Bore	72 mm (2.834")
Stroke	61 mm (2.401")
Displacement	496.7 cm ³ (30.31 in. ³)
Compression ratio (corrected)	6.2:1
Carburetor type	VM 36-104
Carburetor adjustment	
— air screw	1 turn \pm 1/8
— idle speed	1800-2000 R.P.M.
Engine head nuts (torque)	20 N•m (15 ft-lbs)
Fan belt free-play	6 mm (1/4")

CHASSIS

Overall length	276 cm (109")
Overall width	99 cm (39")
Overall height	107 cm (42")
Ski stance (center to center)	85 cm (33 1/2")
Ski alignment (toe out)	3 mm (1/8")
Mass (weight)	manual 207 kg (451 lbs) electric 220 kg (484 lbs)
Bearing area	8710 cm ² (1350 in. ²)
Ground pressure	manual 2.34 kPa (.34 lbs/in. ²) electric 2.47 kPa (.358 lbs/in. ²)

POWER TRAIN

Track dimensions	42 cm (16 1/2") x 315 cm (124")
Track tension	13 mm (1/2") gap should exist between slide shoe and bottom inside of track.
Track alignment	Equal distance between edges of track guides and slider shoes.
Std. gear ratio	19/40
Chaincase oil capacity	200 mL (7 oz.)
Drive belt (minimum width)	3 cm (1 3/16")

ELECTRICAL

Lighting system (output)	12 volts, 140 watts
Headlamp bulb	45/45 W
Tail/stop	5/21 W
Spark plug (Bosch)	W 275 T2 (W3C)
Spark plug (gap)	0.4 mm (.016")
Advanced ignition timing	2.0 mm \pm .10 (.081" \pm .003")

FUEL

Tank capacity	— SI* — Imp. — U.S.	29.5 liters 6.5 gallons 7.8 gallons
Gasoline		Regular
Injection oil	— SI — Imp. — U.S.	2.36 liters 80 ounces 76 ounces

BRAKE

Brake type	Disc. self-adjusting
Brake adjustment (control)	13 mm (1/2") minimum distance from handlebar grip when fully applied
Brake lining (minimum thickness)	3 mm (1/8")

*International Standard

Bombardier Limitée reserves the right to make changes in design and specifications and/or to make additions to, or improvements in its product without imposing any obligation upon itself to install them on its product previously manufactured.

WIRING DIAGRAM

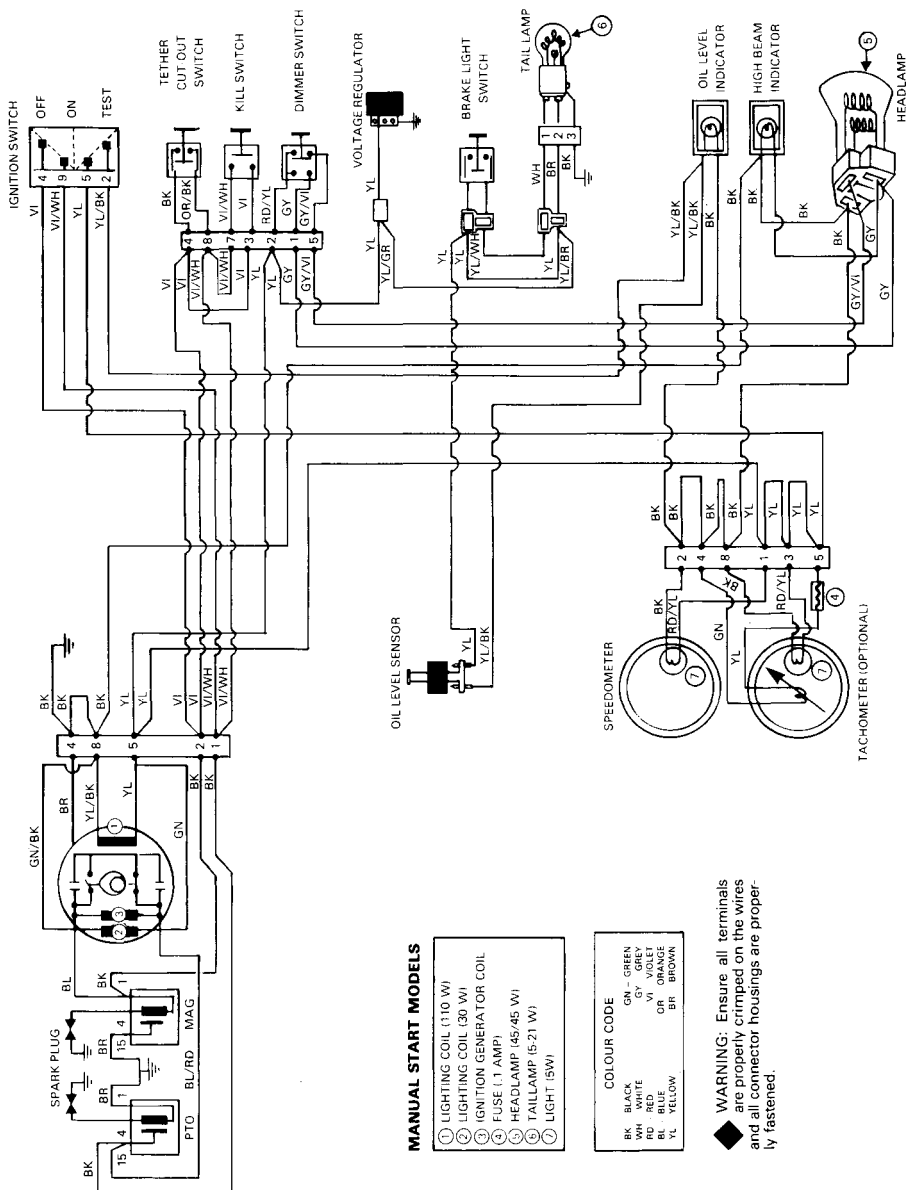

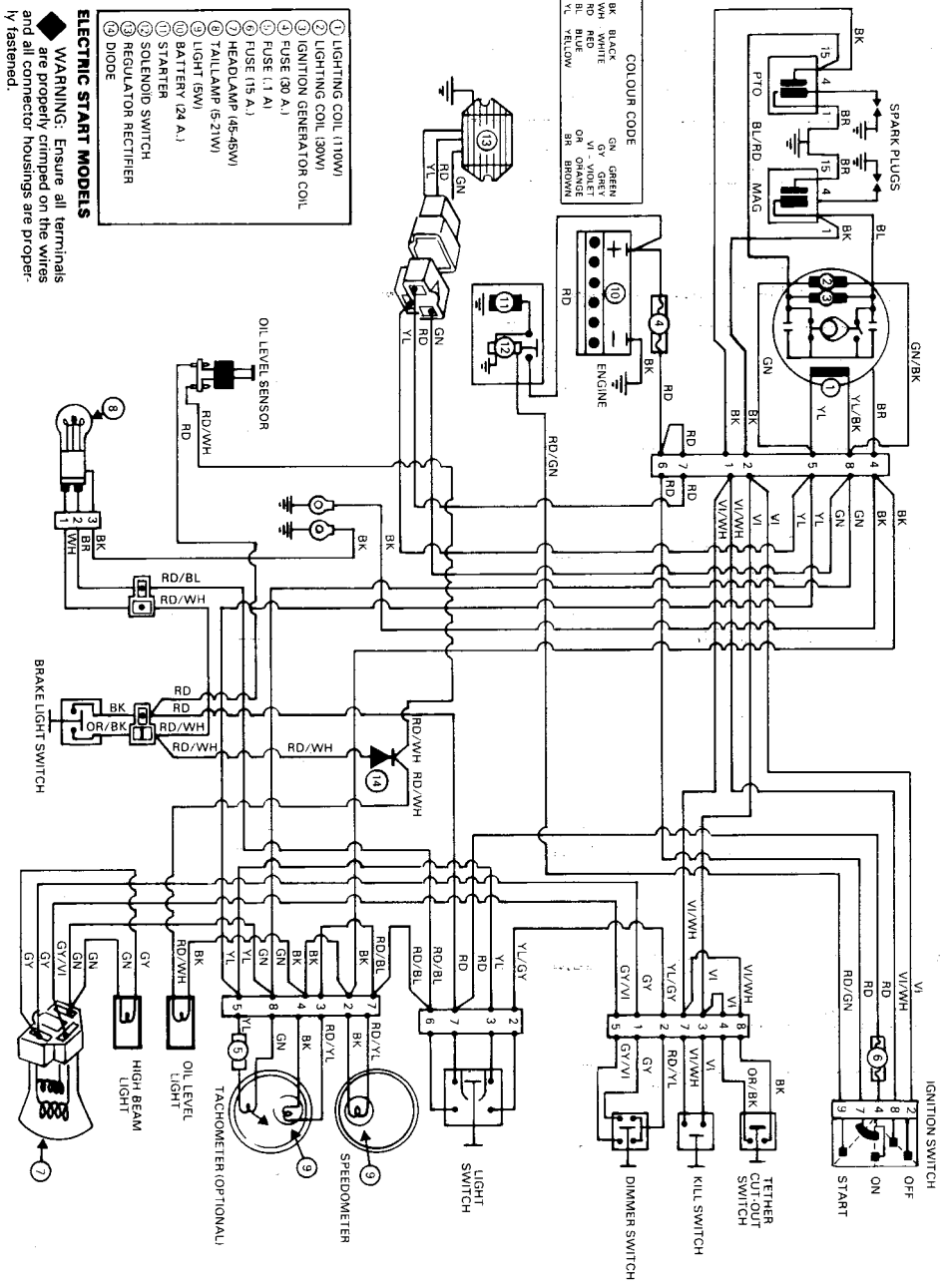

- ① LIGHTING COIL (110W)
- ② LIGHTING COIL (130W)
- ③ LIGHTING COIL (130W)
- ④ FUSE (30 A.)
- ⑤ FUSE (1 A.)
- ⑥ FUSE (15 A.)
- ⑦ HEADLAMP (45-65W)
- ⑧ TAILLAMP (5 21W)
- ⑨ LIGHT (5W)
- ⑩ BATTERY (24 A.)
- ⑪ STARTER
- ⑫ SOLENOID SWITCH
- ⑬ REGULATOR RECTIFIER
- ⑭ DIODE

ELECTRIC START MODELS

WARNING: Ensure all terminals are properly connected on the wires and all connector housings are properly fastened.

SI* METRIC INFORMATION GUIDE

BASE UNITS

DESCRIPTION	UNIT	SYMBOL
length	meter	m
mass	kilogram	kg
liquid	liter	L
temperature	celsius	°C
pressure	kilopascal	kPa
torque	Newton meter	N•m
speed	kilometer per hour	km/h

PREFIXES

PREFIX	SYMBOL	MEANING	VALUE
kilo	k	one thousand	1,000
centi	c	one hundredth of a	0.01
milli	m	one thousandth of a	0.001

*THE INTERNATIONAL SYSTEM OF UNITS (SYSTEME INTERNATIONAL) ABBREVIATES "SI" IN ALL LANGUAGES.

OFTEN ASKED QUESTIONS

Q: Why must my snowmobile be registered? After all I do have my original invoice as proof of when I purchased my snowmobile.

A: Your warranty is valid at any authorized dealer of the product. Your registration is the key element in providing the servicing dealer with the necessary data to complete warranty claim forms. This information is also used to notify owners in the event of a safety recall.

Q: How do I know my vehicle has been registered at the factory?

*A: When you bought your snowmobile the dealer should have completed, and forwarded us the manufacturer's copy of the Customer Warranty Registration. The **hard copy** of the card is your proof that the snowmobile is registered.*

Q: I bought my snowmobile in O'King County but I snowmobile in Washington County. Can the dealer in Washington County accept to perform warranty work on my snowmobile?

A: Yes, any authorized dealer in North America can perform warranty repairs, providing the customer warranty registration card is presented.

Q: Where can I find information on the lubrication and maintenance of my snowmobile?

A: In this Operator Manual provided with the vehicle at the time of first sale.

Q: Will the entire warranty be void or cancelled, if I do not operate or maintain my new snowmobile exactly as specified in the Operator's Manual?

*A: The warranty of the new snowmobile cannot be "Voided" or "Cancelled". However, if a particular failure is caused by operation or maintenance other than is shown in the Operator Manual, **that** failure may not be covered under warranty. This includes service work performed by the customer, especially the critical adjustments to ignition, timing, carburetion and oil injection/or oil mixture.*

Q: Would you give some examples of abnormal use or strain, neglect or abuse?

A: These terms are general and overlap each other in areas. Some specific examples may include: running the machine out of oil, chain failure caused by a lack of lubrication, operating the machine with a broken or damaged part which causes another part to fail, and so on. If you have any specific questions on operation or maintenance, please contact your dealer for advice.

Q: What costs are my responsibility during the warranty period?

A: The customer's responsibility includes all costs of normal maintenance services, non-warranty repairs, accidents and collision damage, as well as oils, and spark plugs, and incidental or consequential damages costs as explained in the warranty.

Q: Are "Genuine" Bombardier replacement parts used in warranty repairs covered by warranty?

A: Yes. When installed by an authorized dealer, any "genuine" Bombardier part used in warranty repairs assumes the remaining warranty that exists on the machine.

Q: What is Bombardier's policy on extending a warranty?

A: It is not Bombardier's policy to extend warranty. Bombardier has selected a warranty period sufficiently long to permit adequate use of the machine to allow for possible concealed manufacturing defects to occur.

Q: Manufacturer does not accept warranty work on seized, scored or melted pistons, why?

A: From testing and experience, we know that such piston failures can only be caused by detonation or pre-ignition, which are directly related to the following factors and therefore, are beyond the manufacturer's control.

- Incorrect oil/gas mixture (too little or too much oil).
- Poor quality, outboard or straight mineral oils.
- Removal of intake silencer.
- Hot spark plug(s) (improper heat range).

Q: If I sell my snowmobile within the warranty period, will the new owner qualify for the balance of the warranty?

A: Yes, provided the unit has already been registered with the manufacturer. Note that the change of ownership card in this manual should be completed and sent to Bombardier Limitée.

LISTING OF AREA DISTRIBUTORS

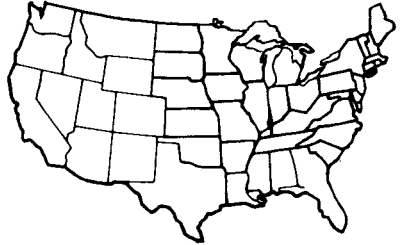

CANADIAN DISTRIBUTORS

ALPINE DISTRIBUTORS LIMITED
Kalamalka Lake Road
P.O. Box 159
Vernon, British Columbia, V1T 6M2
(604) 545-1314
British Columbia

BOMBARDIER LIMITÉE
EASTERN CANADA DISTRIBUTION DIVISION
Atlantic Branch
P.O. Box 670
Shediac, New Brunswick, E0A 3G0
(506) 532-4454
Magdalen Island, Nova Scotia, New Brunswick,
Prince Edward Island

BOMBARDIER LIMITÉE
EASTERN CANADA DISTRIBUTION DIVISION
(Quebec Branch)
1350 Nobel Boulevard
Boucherville, Quebec, J4B 1A1
(514) 527-2469 or 655-6121
Province of Quebec

BOMBARDIER LIMITÉE
EASTERN CANADA DISTRIBUTION DIVISION
Ontario Branch
230 Bayview Drive
Barrie, Ontario, L4M 2Y8
(705) 728-8000
Province of Ontario

BROOKS EQUIPMENT LIMITED
1616 King Edward Street
P.O. Box 985
Winnipeg, Manitoba, R3C 2V8
(204) 633-7247
Manitoba, Saskatchewan

HUDSON'S BAY CO. LTD.
165 Hymus Boulevard
Pointe-Claire, Québec, M4W 1A8
(514) 697-8500
North-West Territories, Franklin District & Keewatin

J.W. RANDALL LIMITED
West Street
P.O. Box 1050
Corner Brook, Newfoundland, A2H 8G7
(709) 634-3533
Newfoundland, Labrador

TRACT EQUIPMENT
14325, 114th Avenue
Edmonton, Alberta, T5M 2Y8
(403) 452-9910
Alberta, Dist. Mackenzie, Yukon, N.W.T.

AMERICAN DISTRIBUTORS

BOMBARDIER CORPORATION
4505 West Superior Street
P.O. Box 6106
Duluth, Minnesota 55806
(218) 628-2881
North Dakota, Minnesota, Wisconsin, Illinois, Missouri,
Michigan, Indiana, Ohio (less eastern half), Tennessee,
Kentucky, West Virginia, Virginia, Northern Idaho,
Northern Wyoming, Montana, Iowa, Washington

ELLIOTT & HUTCHINS INC.
East Main Street Road
Malone, New York 12953
(518) 483-4411
New York, Massachusetts, Connecticut, Rhode Island,
Pennsylvania, New Jersey, Maryland, Delaware, District of
Columbia, Northern half of Ohio.

MILLER EQUIPMENT AND RECREATIONAL CENTER
1049 Whitney Road
Anchorage, Alaska 99501
(907) 274-9513
Alaska

TIMBERLAND MACHINES INC.
10 North Main Street
Lancaster, New Hampshire 03584
(603) 788-4738
Maine, New Hampshire, Vermont

HOW TO IDENTIFY YOUR SNOWMOBILE

The main components of your snowmobile (engine, track and frame) are identified by different serial numbers. It may sometimes become necessary to locate these numbers for warranty purposes or to trace your snowmobile in the event of theft.

ENGINE
SERIAL
NUMBER

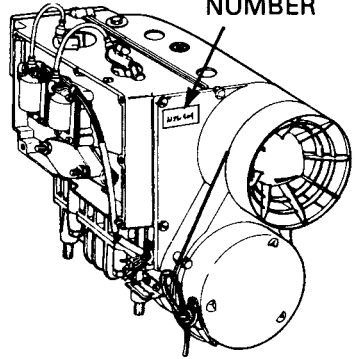

TRACK
SERIAL
NUMBER

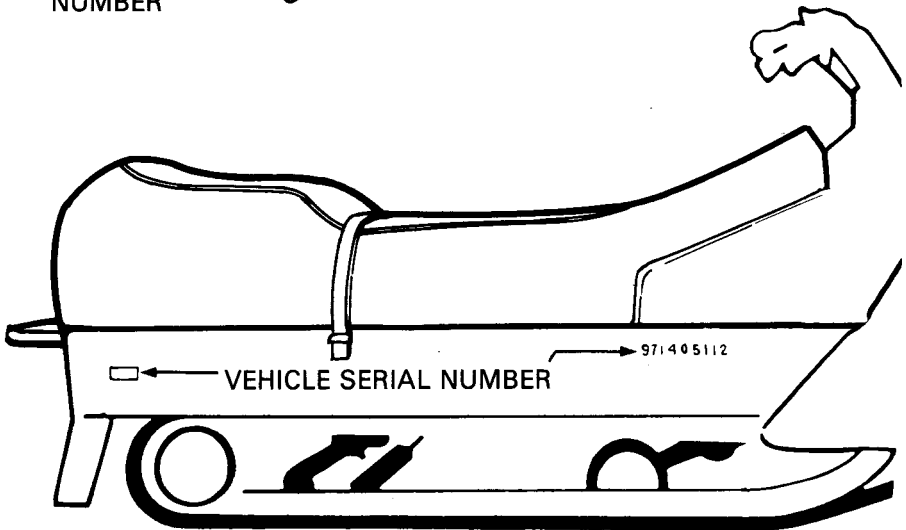
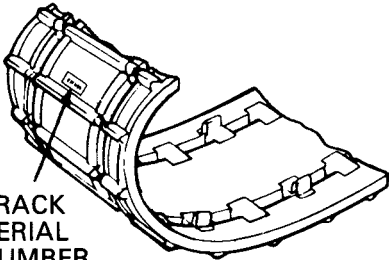

○ **NOTE:** We strongly recommend that you take note of all the serial numbers on your vehicle and supply them to your insurance company. It will surely help in the event a snowmobile is stolen.

CHANGE OF ADDRESS AND OWNERSHIP

Any change in address or ownership should be brought to the attention of the manufacturer by completing and sending out the card supplied below.



CHANGE OF ADDRESS

VEHICLE IDENTIFICATION NUMBER

--	--	--	--	--	--	--	--	--	--	--	--	--	--	--	--	--	--	--	--

OLD ADDRESS:

NAME

NO STREET APT.

CITY STATE ZIP / POSTAL CODE

NEW ADDRESS:

NAME

NO STREET APT.

CITY STATE ZIP / POSTAL CODE



CHANGE OF OWNERSHIP

VEHICLE IDENTIFICATION NUMBER

--	--	--	--	--	--	--	--	--	--	--	--	--	--	--	--	--	--	--	--

The ownership of this vehicle is transferred

FROM:

NAME

NO STREET APT.

CITY STATE ZIP / POSTAL CODE

TO:

NAME

NO STREET APT.

CITY STATE ZIP / POSTAL CODE





BOMBARDIER LIMITÉE
ATT.: WARRANTY DEPARTMENT
VALCOURT, QUEBEC
CANADA, JOE 2L0

BOMBARDIER LIMITÉE
ATT.: WARRANTY DEPARTMENT
VALCOURT, QUEBEC
CANADA, JOE 2L0

