

# ROTAX®



## Operator's Guide

Includes Safety, Use and Maintenance  
Information

# ROTAX 4-TEC 150, 200, 250 AF and Newer Models and 300 ACE AA and Newer Models

**⚠ WARNING**

Read this Manual thoroughly. It contains important safety information.  
Minimum recommended operators age: 16 years old. Keep this Operators  
Manual in the boat.



Version A

# CALIFORNIA PROPOSITION 65 WARNING

## **WARNING**

**This product contains or emits chemicals know to the state of California to cause cancer and birth defects or other reproductive harm.**

All rights reserved. No parts of this Manual may be reproduced in any form without the prior written permission of Bombardier Recreational Products Inc.  
©Bombardier Recreational Products Inc. (BRP) 2018

<sup>TM</sup>®Trademarks of BRP or its affiliates.

This document contains the trademarks of the following companies:

BOSSWeb<sup>TM</sup> is a trademark of BRP.

XPS<sup>TM</sup> is a trademark of BRP.

---

# TABLE OF CONTENTS

## *SAFETY INFORMATION*

<b>FOREWORD</b> .....	<b>6</b>
KNOW BEFORE YOU GO .....	6
SAFETY MESSAGES .....	6
ABOUT THIS OPERATOR'S GUIDE .....	6
REMINDERS REGARDING OPERATION .....	7
<b>SPECIAL SAFETY MESSAGES</b> .....	<b>9</b>
SAFE BOATING PRACTICES .....	12
FUELING .....	14
Use In European Union .....	15
IMPORTANT ON PRODUCT LABELS .....	15
ENGINE IDENTIFICATION NUMBER .....	16

## *WARRANTY INFORMATION*

<b>WARRANTY</b> .....	<b>20</b>
<b>CORROSION WARRANTY STATEMENT</b> .....	<b>36</b>
WARRANTY INFORMATION .....	36
CONSUMER ASSISTANCE .....	38

## *INSPECTIONS AND MAINTENANCE*

<b>PRE-RIDE INSPECTION</b> .....	<b>40</b>
<b>PRE-RIDE CHECKLIST</b> .....	<b>42</b>
<b>MAINTENANCE SCHEDULE</b> .....	<b>44</b>
<b>ROTAX JET PROPULSION PERIODIC MAINTENANCE SCHEDULE</b> .....	<b>45</b>
<b>MAINTENANCE PROCEDURES</b> .....	<b>47</b>
GENERAL .....	47
RECOMMENDED ENGINE OIL FOR ROTAX® 4-TEC 150 AND ROTAX® 4-TEC 150, 200, 250 ENGINES and ROTAX ACE 300 ENGINES .....	47
ENGINE OIL LEVEL .....	47
ENGINE COOLANT .....	49
IGNITION COIL REMOVAL .....	49
Anodes .....	51
Hull Finish .....	52
EXHAUST SYSTEM FLUSHING .....	52
POST OPERATION CARE .....	53
STORAGE .....	54

## *TROUBLESHOOTING GUIDELINES*

<b>TROUBLESHOOTING CHARTS</b> .....	<b>62</b>
<b>MONITORING SYSTEM</b> .....	<b>67</b>
GENERAL .....	67
PILOT LAMPS AND MESSAGE DISPLAY INFORMATION (TYPICAL) ....	67

## *BREAK-IN AND SPECIAL PROCEDURES*

<b>BREAK-IN</b> .....	<b>70</b>
OPERATION .....	70

ENGINE SPEED LIMITATION — 200, 250 SINGLE ENGINE MODELS AND ALL 300 MODELS ONLY ..... 70

ENGINE SPEED LIMITATION — 200, 250 TWIN ENGINE MODELS ONLY ..... 70

CLEANING ..... 70

IN THE WATER TOWING HOSE PINCHER INSTALLATION LOCATIONS ..... 72

# **SAFETY INFORMATION**

# FOREWORD

Congratulations on your purchase of a new Power Pack by BRP. It is backed by the BRP limited warranty and a network of authorized *Rotax* Jet Propulsion dealers ready to provide the parts, service or accessories you may require.

Your dealer is committed to your satisfaction. If you need more complete servicing information, please ask your dealer.

## KNOW BEFORE YOU GO

To learn how to reduce the risk of accident, read the following sections of this Manual before you operate the boat:

SAFETY INFORMATION

POWER PACK INFORMATION

Also, read all safety labels on your boat.

We highly recommend that you take a safe boating course. Please check your dealer or local authorities for availability in your area.

In certain areas, an operator competency card is mandatory to operate a pleasure craft.

Failure to follow the warnings contained in this Operator's Manual can result in **SERIOUS INJURY** or **DEATH**.

## SAFETY MESSAGES

The types of safety messages, what they look like and how they are used

in this Manual are explained as follows:

### **WARNING**

Identifies an instruction which, if not followed, may cause serious injury including the possibility of death.

### **CAUTION**

Identifies an instruction which, if not followed, may cause minor or moderate injury.

### **NOTICE**

Denotes an instruction which, if not followed, may severely damage the engine or other components.

**IMPORTANT:** Indicates supplementary information which may be needed to fully complete or understand an instruction.

### **ENVIRONMENTAL NOTE**

Environment note gives you tips and behaviors to environmental protection.

## ABOUT THIS OPERATOR'S GUIDE

This Operators Manual has been prepared to acquaint the owner and the operator of a new boat with the various controls, maintenance and safe operating instructions. It is indispensable for the proper use of the product. Keep this Operators Manual in the boat as you can refer to it for things such as maintenance, troubleshooting and instructing others.

Note that this Manual is available in several languages. In the event of any discrepancy, the English version shall prevail. If you want to view and/or print an extra copy of your Operator's

Manual, simply visit the following website at:

<http://www.operatorsguides.brp.com>

The information contained in this document are correct at the time of publication. BRP, however, maintains a policy of continuous improvement of its products without imposing upon itself any obligation to install them on products previously manufactured. Due to late changes, some differences between the manufactured product and the descriptions and/or specifications in this Manual may occur. BRP reserves the right at any time to discontinue or change specifications, designs, features, models or equipment without incurring any obligation upon itself.

This Operators Manual should remain with the boat when it's sold.

## REMINDERS REGARDING OPERATION

### **WARNING**

**Avoid personal injury! Do not allow anyone near the jet pump or intake grate, even when the engine is off. Items such as long hair, loose clothing or personal flotation device straps can become entangled in moving parts resulting in serious injury or drowning. In shallow water, shells, sand, pebbles or other objects could be drawn up by the jet pump and be thrown rearward.**

Engine exhaust contains carbon monoxide (CO), which can cause injury or death if inhaled in sufficient quantities. Educate all occupants about the risks and symptoms of CO accumulation and CO poisoning. For more information, refer to CARBON MONOXIDE AND BOATING section.

Gasoline vapors can explode, resulting in injury or death. Always use blower for a minimum of 5 minutes

before starting engine, then turn it OFF above idle speed. Use of the bilge blower should never replace "smelling" for gasoline vapor odors.

If at any time, gasoline leaks/odors are found, do not start the engine. Have the boat serviced by an authorized Rotax Jet Propulsion marine engine dealer.

Always keep in mind that as the throttle lever is returned to the idle position, less directional control is available. To turn the boat, both steering and throttle are necessary.

This boat has no brake. Stopping distance will vary depending on initial speed, load, wind, and water conditions. Practice stopping and docking in a safe, traffic-free area to have an idea of how long it will take to stop the boat under varying conditions. Do not release the throttle when trying to steer away from objects. You need throttle to steer. Do not use the boat's reverse to stop.

Do not start or operate the boat if any person is not properly seated in a seat intended for use when underway (refer to boat labels) or if a person is nearby in the water.

The boat's jet thrust can cause injury. Always accelerate slowly, and decelerate in a controlled fashion.

Observe the instructions on all safety labels. They are there to help assure that you have a safe and enjoyable outing.

Riding with passenger (s) or pulling other boats, tubes, a skier or a wake boarder makes the boat handle differently and requires greater skills.

In shallow water, proceed with caution and at very low speeds. Grounding or abrupt stops may result in injury to you, your passengers or others. The jet pump may pick up debris and throw it rearward causing a risk of injuring

people or damaging the jet pump or other property.

Combustion engines need air to operate; consequently this boat can not be totally water-tight. Any maneuvers such as figure eights that cause the upper deck to be under water may cause severe engine problems due to water ingestion. Refer to the **SPECIAL PROCEDURES** and **WARRANTY** sections contained in this Operators Manual.

Respect no wake zones, the rights of other water users and the environment. As the “skipper” and owner of a boat, you are responsible for damage to other boats caused by the wake of your boat. Do not let anyone throw refuse overboard.

Between sunset and sunrise, use the boat's navigation lights and reduce speed. Do not operate the boat in reduced visibility.

Do not add accessories or equipment that may adversely affect visibility or alter control of the boat.

The skipper should personally take the helm during storms.



---

# SPECIAL SAFETY MESSAGES

## CARBON MONOXIDE AND BOATING

Burning a material containing carbon produces carbon monoxide (CO), an odorless and colorless gas. Because CO has a similar density as air, it can spread throughout an enclosed space unnoticed because you cannot see it or smell it. Any device used to burn carbon-based materials on a boat can be a source of CO. Common sources of CO include internal combustion engines.

CO reacts with the blood to reduce the ability of the blood to carry oxygen. The reduced oxygen supply to body tissues results in death of the tissue. Prolonged exposure can cause brain damage or death. In high concentrations, CO can be fatal within minutes. The effects of CO in lower concentrations are cumulative and can be just as lethal over long periods of time.

Symptoms of CO poisoning include: Itchy and watering eyes, flushed appearance, throbbing temples, inability to think coherently, ringing in the ears, tightness across the chest, head-aches, drowsiness, nausea, dizziness, fatigue, vomiting, collapse, and convulsions. If any of these symptoms are evident, begin treatment immediately. Prompt action can make the difference between life and death.

Evacuate the area and move the victim to fresh air.

Administer oxygen if available and get medical help.

Open all canvas enclosures to ventilate the area.

Investigate the source of CO and take immediate corrective action.

Be especially aware of other CO sources which may be near boat.

## CARBON MONOXIDE ACCUMULATION

Following are examples of possible situations where CO may accumulate within your boat while docked, anchored, or underway. Become familiar with these examples and their precautions to prevent personal injury or death.

### WARNING

**Exhaust fumes! Generator or hull exhaust from other vessels while either docked or anchored can emit poisonous CO gas and cause excessive accumulation within cabin and cockpit areas. Be alert for generator exhaust from your vessel or other vessels alongside. Exhaust outlets near a pier, dock, seawall or outlets blocked by any other means can cause excessive accumulation of poisonous CO gas within cockpit area.**

## CARBON MONOXIDE ACCUMULATION

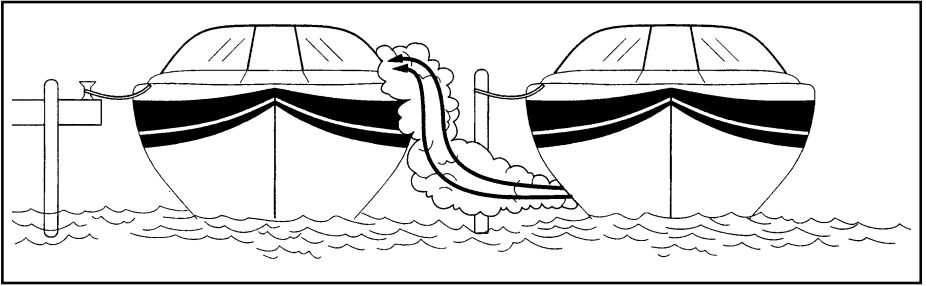

### **⚠ WARNING**

**Engine exhaust fumes contain carbon monoxide (CO) which can accumulate in and around the boat (under bimini top, in cockpit, etc.). CO can be harmful or fatal if inhaled. Assure there is adequate ventilation whenever running engine(s).**

Boat houses, seawalls, and other boats in close proximity or confined areas can contribute to increased CO levels. Operators must be aware that operation, mooring, and anchoring in an area with other boats puts them in jeopardy of CO accumulation from other sources. Likewise, a boat operator must be aware of how exhaust from his boat will affect others. Operation of the engines while moored may cause CO accumulation in your boat and those around you.

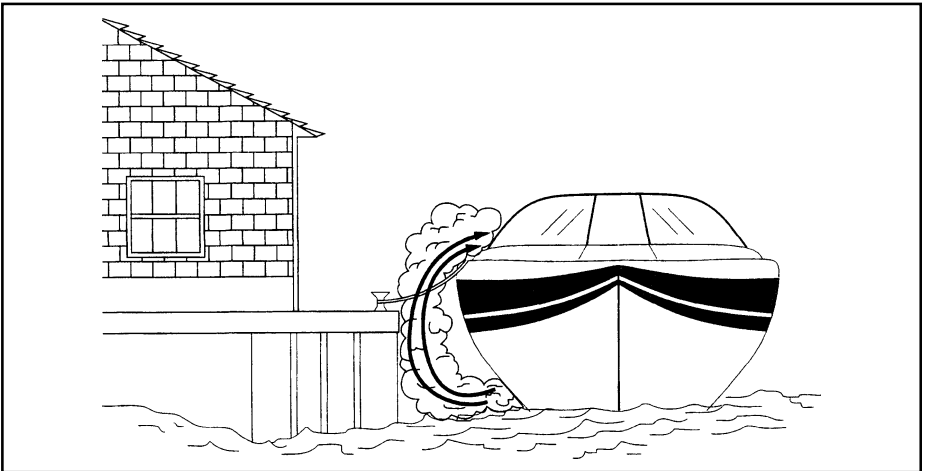

## CARBON MONOXIDE ACCUMULATION

Be sure to provide adequate ventilation. If the windshield has vents, open them before getting underway to increase positive air flow and decrease the chances of CO accumulation.

### WARNING

**Backdrafting! Under certain conditions, moving air currents can direct poisonous CO fumes into boat. These fumes can accumulate to dangerous levels without proper air-flow. Provide adequate ventilation, redistribute the load or bring boat out of high bow angle.**

While underway, CO concentrations can increase by backdrafting or “the station wagon effect”. Backdrafting is caused by factors such as relative wind direction, speed, or the bow being too high. To prevent this, open canvas whenever possible to provide positive airflow through the hull.

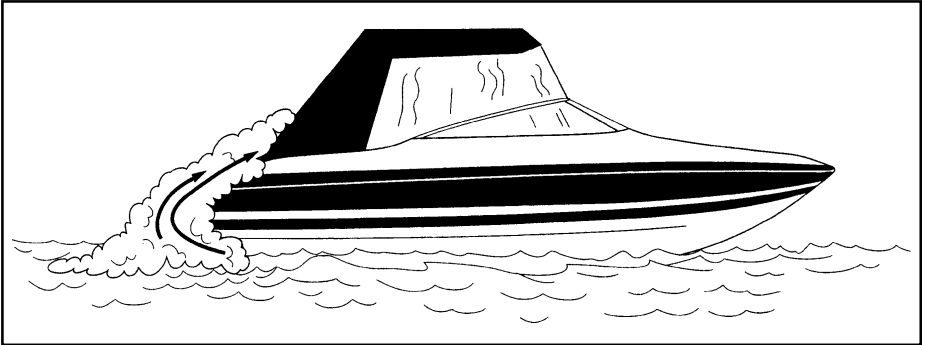

Even with the best boat design and construction, CO may still accumulate in enclosed or confined areas under certain conditions. Continually observe passengers for symptoms of CO poisoning.

## CO DETECTOR

It is strongly recommended that you have CO detectors installed in boats with canvas enclosures. Monitors are available from your dealer. Monitors should be professionally installed and calibrated.

A CO detector is not a gas fuel vapor detector. Gas fuel vapor detectors do not monitor the buildup of CO in an enclosed area.

**DO NOT** Operate your Boat Without Performing the Following Checklist:

OPERATION	SIGN
Make sure you and your passengers know where exhaust outlets are located on the vessel.	
Educate all passengers about the symptoms of CO poisoning and where CO may accumulate.	
When docked or rafting with another boat, be aware of exhaust emissions from the other boat.	
Listen for any change in exhaust sound, which could indicate an exhaust component failure.	
Test the operation of each CO alarm by pressing the test button (if applicable).	

## SAFE BOATING PRACTICES

YOU are responsible for your own safety, the safety of your passengers, and the safety of fellow boaters.

## DRUGS AND ALCOHOL

Do not use drugs or drink alcohol while operating a boat. Like driving a car, driving a boat requires sober, attentive care. Operating a boat while intoxicated or under the influence of drugs is not only dangerous, but it is also a Federal offense carrying a significant penalty. These laws are vigorously enforced. The use of drugs and alcohol, singly or in combination, decreases reaction time, impedes judgment, impairs vision, and inhibits your ability to safely operate a boat.

### WARNING

**Alcohol consumption and boating are a deadly combination! Operating under the influence endangers the lives of your passengers and other boaters. Federal laws prohibit operating a boat under the influence of alcohol or drugs.**

## SAFE OPERATION

For safety reasons and proper care, always perform daily PRE-RIDE INSPECTION as specified in your Operators Manual before operating your boat. Safe operation means that you do not misuse your boat nor do you allow your passengers to do so. Safe operation means using good judgment at all times. It includes, without limitation, the following actions:

Load the boat within the limits listed on the capacity plate. Balance loads bow to stern and port to starboard.

Maintain boat speed at or below the local legal limit. Avoid excessive speed or speeds not appropriate for operating conditions.

Do not use the boat in weather or waterway conditions beyond the skill or experience of the operator or the capability of the boat and comfort of passengers.

Be sure at least one other passenger is familiar with the operation and safety aspects of the boat in case of an emergency.

Make sure that passengers and gear do not obstruct the operator's view or ability to move.

Do not exceed the maximum engine power rating stated on the certification plate attached to the boat.

Observe all safety signs and warnings both inside the boat and in the immediate boating area.

While your boat has the capacity of operating at high speeds, it is strongly recommended that high speed operation only be applied when ideal conditions exist and are permitted. Higher speed operation requires a higher degree of skill and increases the risk of severe injuries.

In shallow water, proceed with caution and at very low speed. Grounding or abrupt stops may result in injury. Debris may also be picked up and be thrown rearward by the jet pump onto people or property.

Do not use the boat's reverse, to stop. You or your passenger (s) could be violently ejected forward or even off the boat onto the hazard.

## **MANEUVERABILITY OF THE BOAT AND TOWING**

Always keep in mind that as the throttle lever is returned to idle position, less directional control is available, and when the engine is OFF, directional control is lost. You need throttle to steer.

Do not overload the boat or take on more passengers than designated for the particular boat. Overloading can affect maneuverability, stability and performance.

Avoid adding on accessories or equipment which may alter your control of the boat.

Riding with a passenger(s) or pulling a tube, skier or wakeboarder makes the

boat handle differently and requires greater skill.

Always respect the safety and comfort of your passenger (s) and person being towed on skis, wakeboard or other towables.

Always carry an observer when pulling a tube, skier or wakeboarder, proceed with only as much speed as required and follow the observer's instructions. Unless absolutely necessary, do not make tight, sharp turns. Keep a safe distance from the docks, other swimmers, craft or objects.

Use a tow rope of sufficient length and size and make sure it is adequately secured to your boat. Some boats are equipped or can be fitted with a specially designed towing mechanism. It can become a hazard should someone fall on it.

## **PASSENGER SAFETY**

Before getting underway, show all passengers where emergency and safety equipment is stowed, and explain how to use it. Everyone aboard should wear rubber-soled shoes which resist slipping on wet surfaces. While underway, passengers should remain seated inside the deck rails. Don't allow passengers to drag their feet or hands in the water. Always use hand holds and other safety hardware to prevent falls. All non-swimmers, poor swimmers, and children should wear a PFD at all times. Federal regulations require that children under 13 years of age wear a PFD when the boat is underway unless they are in an enclosed cabin or below deck.

Do not start or operate the boat if anyone is seated on the sun deck or swim platform, or is nearby in the water. Water and/or debris exiting jet thrust nozzle can cause severe injury.

The operator and passenger(s) should be properly seated before starting or moving the boat. All passenger (s)

should be instructed to use the hand holds or seat straps provided.

When accelerating a boat with a passenger (s), whether from a complete stop or while underway, always do so progressively. Fast acceleration may cause your passenger(s) to lose their balance or grip and strike something in the boat or fall out of the boat. Make sure that your passenger(s) know of, or anticipate, any rapid acceleration.

## FIRST AID

As a boat operator, you should be familiar with basic first aid procedures that may be needed while you are far from help. Fish hook accidents or minor cuts and abrasions may be the most serious mishaps on board a boat, but you should also learn the proper procedures and be ready to deal with the truly serious problems like excessive bleeding, hypothermia, and burns. First aid literature and courses are available through most Red Cross chapters.

## OPERATION BY MINORS

Minors should always be supervised by an adult whenever operating a boat. Many countries have laws regarding the minimum age and licensing requirements of minors. Be sure to contact the state boating authorities for information. BRP recommends a minimum operator age of 16 years.

## FUELING RECOMMENDED FUEL

### NOTICE

**Always use fresh gasoline. Gasoline will oxidize; the result is loss of octane, volatile compounds, and the production of gum and varnish deposits which can damage the fuel system.**

Alcohol fuel blending varies by country and region. Your engine has been

designed to operate using the recommended fuels, however, be aware of the following:

- Use of fuel containing alcohol above 10% is not recommended and can result in the following problems in the fuel system components:
  - Starting and operating difficulties
  - Deterioration of rubber or plastic parts
  - Damage to internal engine parts
- Inspect frequently for the presence of fuel leaks or other fuel system abnormalities if you suspect the presence of alcohol in gasoline exceeds the current government regulations.
- Alcohol blended fuels attract and hold moisture which may lead to fuel phase separation and can result in engine performance problems or engine damage.

Use premium unleaded gasoline with an AKI (RON + MON)/2 rating of 91 or an RON octane rating of 95.

### NOTICE

**Never experiment with other fuels. The use of inadequate fuel can result in boat performance deterioration and damage to critical parts in the fuel system and engine components.**

### NOTICE

**Do NOT use fuel from fuel pumps labeled E85.**

Use of fuel labeled E15 is prohibited by U.S. EPA.

MINIMUM OCTANE RATING		
AKI (RON+ MON/2)	87	91
150 (ECT)	X	
200 (ECT)	X	X <sup>1</sup>
250 (ECT)	X	X <sup>1</sup>
300	X	X <sup>1</sup>

MINIMUM OCTANE RATING		
RON	92	95
150 (ECT)	X	
200 (ECT)	X	X <sup>1</sup>
250 (ECT)	X	X <sup>1</sup>
300	X	X <sup>1</sup>
<sup>1</sup> For optimum engine performance		

## FUELING PROCEDURE

### **⚠ WARNING**

**Fuel is flammable and explosive under certain conditions. Do not smoke or allow open flames or sparks in the vicinity.**

Be very careful when fueling and adhere to the fueling procedures described below in this Operators Manual and those given to you by the marina.

Know the capacity of the fuel tank. Avoid fueling at night except under well-lighted conditions. Gas spills are not noticeable in the dark. Do not carry spare fuel or flammable liquids

in any of the storage or engine compartments.

### **⚠ WARNING**

**Follow these safe boating fueling instructions explicitly.**

## Use In European Union

(2014/94/EU — on the deployment of alternative fuels infrastructure)

A European Standard provides harmonized labeling across Europe and this effectively assists consumers in identifying the compatibility of the fuel supplied at a refueling point with an engine.

In the European Union, this Rotax engine is compatible with the following petrol-type fuel;

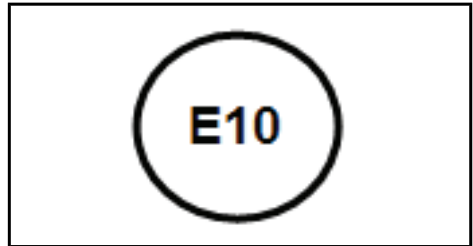

## IMPORTANT ON PRODUCT LABELS

The following labels are on your engine. If missing or damaged, they can be replaced free of charge. See an authorized dealer. Please read the following labels carefully before operating your boat.

**IMPORTANT:** The illustration indicates the approximate locations of the various labels. A dashed line indicates the label is not on the outer surface, and cover must be opened to see the label(s).

## LABEL LOCATION

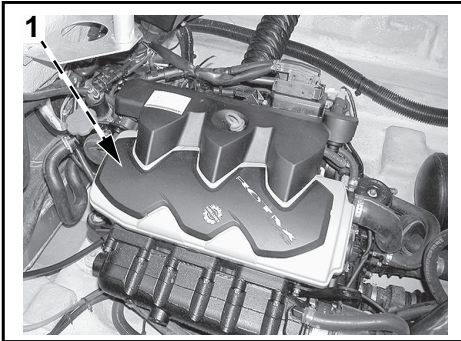

1. Cover

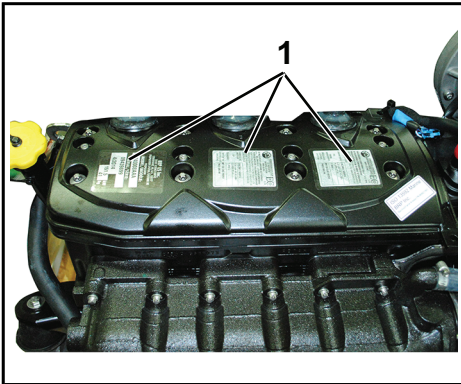

1. Labels

## LABELS



LABEL-ISO 13592



TYPICAL-MODEL/SERIAL

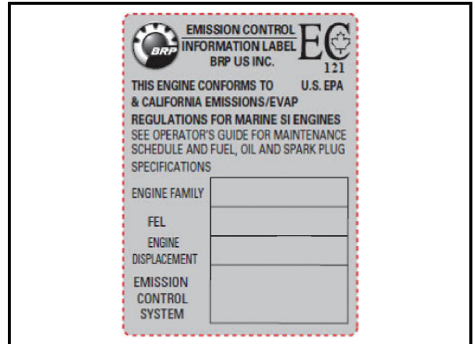

TYPICAL (WHEN APPLICABLE)-EMIS- SIONS CONTROL INFORMATION

## ENGINE IDENTIFICATION NUMBER

The Engine Identification Number is located on the front of the engine as well as under the beauty cover.



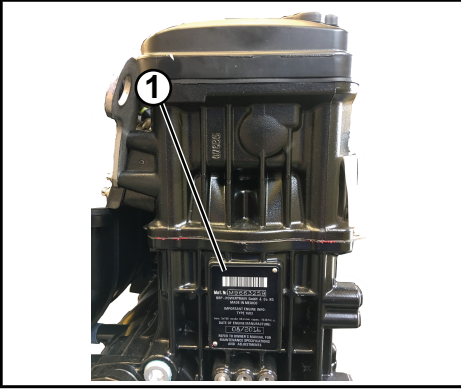

**FRONT OF ENGINE**

1. Engine identification number

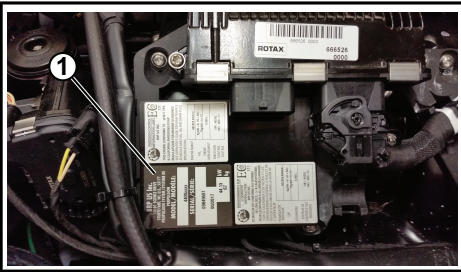

**TOP OF ENGINE**

1. Engine identification number

This page is intentionally blank

# WARRANTY INFORMATION

---

# WARRANTY

## BRP US INC. LIMITED WARRANTY FOR ROTAX® INBOARD JET PROPULSION SYSTEMS

### ***1. Scope Of The Limited Warranty***

BRP US Inc.\* ("BRP") warrants its Rotax® Inboard Jet Propulsion Systems which are incorporated into boats made by authorized manufacturers and sold through authorized dealers in the fifty United States and Canada ("Product") from defects in material or workmanship for the period and under the conditions described below.

All genuine Rotax® Inboard Jet Propulsions Systems parts and accessories, including nut not limited to impellers, gauges, fuel pump assemblies, remote controls, and wiring provided by Rotax® Inboard Jet Propulsion Systems are installed by an authorized Rotax® Distributor at the time of assembly of the product bear the standard BRP limited warranty for Rotax® Jet Propulsion Systems parts and accessories. See your authroized Rotax® Inboard Jet Propulsion Systems distributor/dealer for a full copy of such limited warranty.

This warranty will become null and void if:

(1) Product was used for racing or any other competitive activity at any point, even by a previous owner; or (2) Product has been altered or modified in such a way so as to adversely affect its operation, performance or durability, or (3) the product has been altered or modified to change its intended use, horsepower or emission levels.

### ***2. Exclusions - The following are not warranted under any circumstances:***

- Replacement of parts due to normal wear and tear;
- Routine maintenance parts and services including but not limited to: maintenance requirements, oil changes, lubrication, valve and linkage adjustments and replacement of fuses, zinc anodes, thermostats, timing belts, filters, impellers;
- Damage caused by improper or lack of installation, maintenance, winterization and/or storage, failure to follow the procedures and recommendations in the Operators Manual;
- Damage resulting from removal of parts, improper repairs, service, maintenance, or modification, or use of parts or accessories not manufactured or approved by BRP, which in its reasonable judgment, are either incompatible with Product or adversely affect its operation, performance, or durability, or resulting from repairs done by a person that is not an authorized Dealer (as described below);
- Damage caused by abuse, misuse, abnormal use, neglect, racing, improper operation or operation of the Product in a manner inconsistent with the recommended operation described in the Operators Manual;
- Damage resulting from external damage, accident, submersion, water ingestion, fire, theft, vandalism or any act of God;
- Operation without proper fuel, oil or lubrication, or with fuels, oils or lubricants which are not suitable for use with the Product (see the Operators Manual);
- Damage resulting from rust

## **BRP US INC. LIMITED WARRANTY FOR ROTAX® INBOARD JET PROPULSION SYSTEMS**

- Damage resulting from corrosion (see Rotax® Inboard Jet Propulsion Systems Limited Corrosion Warranty)
- Damage caused from cooling system blockage by foreign material;
- Damage resulting from sand or debris in the jet pump;
- Cosmetic or paint changes due to exposure to the elements.
- This warranty will be voided in its entirety and rendered null and void where:
- The boat which incorporates the Product was used for racing or any other competitive activity, at any point, even by previous owner or Product has been altered or modified in such a way so as to adversely affect its operation, performance or durability, or change its intended use, horsepower or emission levels.

### ***3. Limitations of Liability***

**ALL WARRANTIES, EXPRESSED OR IMPLIED, INCLUDING WITHOUT LIMITATION ANY WARRANTY OF MERCHANTABILITY OR FITNESS FOR A PARTICULAR PURPOSE ARE LIMITED IN DURATION TO THE LIFE OF THE EXPRESS LIMITED WARRANTY. ALL INCIDENTAL, CONSEQUENTIAL, DIRECT, INDIRECT OR OTHER DAMAGES OF ANY KIND ARE EXCLUDED FROM COVERAGE UNDER THIS WARRANTY INCLUDING, BUT NOT LIMITED TO: expense for gasoline, expense for transporting Product to and from Dealer, removal of Product from a boat and reinstallation, mechanic's travel time, in and out of water charges, slip or dock fees, trailering or towing, storage, telephone, cell phone, fax or telegram charges, rental of a like or replacement Product or boat during warranty services or down time, taxi, travel, lodging, loss of or damage to personal property, inconvenience, cost of insurance coverage, loan payments, loss of time, loss of income, revenue or profits, or loss of enjoyment or use of Product. SOME STATES, PROVINCES, OR JURISDICTIONS DO NOT ALLOW FOR THE DISCLAIMERS, LIMITATIONS OF INCIDENTAL OR CONSEQUENTIAL DAMAGES, OR OTHER EXCLUSIONS IDENTIFIED ABOVE. AS A RESULT, THEY MAY NOT APPLY TO YOU. THIS WARRANTY GIVES YOU SPECIFIC RIGHTS, AND YOU MAY ALSO HAVE OTHER LEGAL RIGHTS WHICH MAY VARY FROM STATE TO STATE, OR PROVINCE TO PROVINCE.**

No distributor, Dealer or any other person is authorized to make any affirmation, representation or warranty regarding Product other than those contained in this limited warranty and, if made, shall not be enforceable against BRP. BRP reserves the right to modify this warranty at any time, being understood that such modification will not alter the warranty conditions applicable to the Products sold while this warranty is in effect.

### ***4. Warranty Coverage Period***

This limited warranty will be in effect from the date of delivery to the first retail consumer or the date the Product is first put to use, whichever occurs first, for a period of:

## **BRP US INC. LIMITED WARRANTY FOR ROTAX® INBOARD JET PROPULSION SYSTEMS**

1. THIRTY-SIX (36) CONSECUTIVE MONTHS for private, recreational use; or
2. TWELVE (12) CONSECUTIVE MONTHS for commercial use, The Product is used commercially when it is used in connection with any work or employment that generates income, during any part of the warranty period. The Product is also used commercially when, at any point during the warranty period, it is installed on a boat that has commercial tags or is licensed for commercial use.
3. For emission related components; please also refer to the U.S. EPA EMISSION-RELATED WARRANTY contained herein.
4. For Rotax® Inboard Jet Propulsion Systems produced by BRP for sale in the state of California that are originally sold to a resident or subsequently warranty registered to a resident of the State of California, please also refer to the applicable California Emissions Control Warranty Statement contained herein.

In cases where the delivery date is not established to BRP's satisfaction, the date of sale will be used to determine the warranty start date. The repair or replacement of parts or the performance of service to Product under this warranty does not extend the life of this limited warranty beyond its original expiration date.

For all Rotax® Jet Propulsion System genuine parts and accessories installed by an authorized dealer at the time of sale, reference the BRP parts and accessories limited Warranty Statement.

### ***5. Conditions To Warranty Coverage***

This warranty coverage is available only on Rotax® Inboard Jet Propulsion Systems purchased as new and unused from a dealer authorized to distribute Rotax® Inboard Jet Propulsion Systems products in the country in which the sale occurs ("Dealer"), and then only after the BRP specified pre-delivery inspection process has been completed and documented by the purchaser and Dealer. Warranty coverage only becomes available upon proper registration of Product by Dealer or owner.

Only the original purchaser and any subsequent owners who reside in the United States and Canada and have purchased Product from a U.S. or Canadian Dealer are eligible for warranty registration and warranty coverage hereunder. Such limitations are necessary in order to allow BRP to protect the safety of its products, its consumers, and the general public.

As outlined in the Operators Manual, timely routine required maintenance must be performed to maintain warranty coverage. BRP may require proof of proper maintenance prior to authorizing warranty coverage.

### ***6. What To Do To Obtain Warranty Coverage***

The registered owner must notify an authorized Dealer within two (2) days of the appearance of a defect. BRP is not responsible for damages caused by

---

## **BRP US INC. LIMITED WARRANTY FOR ROTAX® INBOARD JET PROPULSION SYSTEMS**

the use of a Product after the appearance of a defect. Owner must bring Product, including any defective part therein, to Dealer promptly after the appearance of the defect, and in any event, within the warranty period, and must provide Dealer with reasonable opportunity to repair the defect. The expenses of trans-portioning Product to and from Dealer for warranty service are to be borne by the owner. If the Product has not previously been registered, the owner may also be required to present proof of purchase to Dealer for warranty repairs. Owner is required to sign the repair work order prior to the start of the repair in order to validate the warranty repair. All parts replaced under this warranty become the property of BRP.

### ***7. What BRP Will Do***

BRP's obligations under this warranty are limited to, at its sole discretion, repairing or replacing parts of Product found to be defective in material or workmanship, in the reasonable judgment of BRP. Such repair or replacement of parts will be done without charge for parts and labor, at any authorized Dealer. BRP's responsibility is limited to making the required repairs or replacements of parts with new or BRP-certified remanufactured parts. No claim of breach of warranty shall be cause for cancellation or rescission of the sale of Product to owner.

In the event that warranty service is required outside of the fifty United States or Canada, owner will bear responsibility for any additional charges due to local practices and conditions, such as, but not limited to, freight, insurance, taxes, license fees, import duties, and any and all other financial charges, including those levied by governments, states, territories and their respective agencies.

BRP reserves the right to improve, modify or change Products from time to time without assuming any obligation to modify Products previously manufactured.

## **BRP US INC. LIMITED WARRANTY FOR ROTAX® INBOARD JET PROPULSION SYSTEMS**

### **8. Transfers**

If the ownership of Product is transferred during the warranty coverage period, this warranty shall also be transferred and be valid for the remaining coverage period provided that BRP is notified of such transfer of ownership in the following way:

1. The former owner contacts BRP or a Dealer and gives the coordinates of the new owner; or
2. BRP or a Dealer receives a proof that the former owner agreed to the transfer of ownership, in addition to the coordinates of the owner.

### **9. Consumer Assistance**

In the event of a controversy or dispute in connection with this BRP limited warranty, BRP recommends that you first try to resolve the issue at the dealership level by discussing the issue with Dealer's service manager or owner;

If further assistance is required, please contact BRP US Inc., Attn: Consumer Support, P.O. Box 597, Sturtevant, Wisconsin 53177, 1-262-884-5993.

## **US EPA EMISSION-RELATED WARRANTY**

BRP US Inc. ("BRP") warrants to the ultimate purchaser and each subsequent purchaser that this new engine, including all parts of its exhaust emission control system and its evaporative emission control system, meets two conditions:

1. It is designed, built, and equipped so it conforms at the time of sale to the ultimate purchaser with the requirements of 40 CFR 1045 and 40 CFR 1060.
2. It is free from defects in materials and workmanship that may keep it from meeting the requirements of 40 CFR 1045 and 40 CFR 1060.

Where a warrantable condition exists, BRP will repair or replace, as it elects, any part or component with a defect in materials or workmanship that would increase the engine's emissions of any regulated pollutant within the stated warranty period at no cost to the owner, including expenses related to diagnosing and repairing or replacing emission-related parts. All defective parts replaced under this warranty become the property of BRP.



## US EPA EMISSION-RELATED WARRANTY

For all emission-related warranty claims, BRP is limiting the diagnosis and repair of emission-related parts to the authorized Rotax® Jet Propulsion dealers, unless for emergency repairs as required by item 2 of the following list.

As a certifying manufacturer, BRP will not deny emission-related warranty claims based on any of the following:

1. Maintenance or other service BRP or BRP's authorized facilities performed.
2. Engine/equipment repair work that an operator performed to correct an unsafe, emergency condition attributable to BRP as long as the operator tries to restore the engine/equipment to its proper configuration as soon as possible.
3. Any action or inaction by the operator unrelated to the warranty claim.
4. Maintenance that was performed more frequently than BRP specify.
5. Anything that is BRP fault or responsibility.
6. The use of any fuel that is commonly available where the equipment operates unless BRP written maintenance instructions state that this fuel would harm the equipment's emission control system and operators can readily find the proper fuel. See maintenance information section and fuel requirements section.

**EMISSION-RELATED WARRANTY PERIOD**

The emission-related warranty is valid for the following period whichever comes first: For model: Rotax® 4-TEC 150 ECT, Rotax® 4-TEC 200 ECT and Rotax® 4-TEC 250 ECT.

	<b>HOURS</b>	<b>MONTHS</b>
Exhaust emission-related components	480	36
Evaporative emission related components	N/A	24

For model: Rotax® 4-TEC 150 and 300 ACE (these models are not allowed in the state of California)

	<b>HOURS</b>	<b>MONTHS</b>
Exhaust emission-related components	175	30
Evaporative emission related components	N/A	24

## COMPONENTS COVERED

The emission-related warranty covers all components whose failure would increase an engine's emissions of any regulated pollutant, including the following listed components:

1. For exhaust emissions, emission-related components include any engine parts related to the following systems:
  - Air induction system
  - Fuel system
  - Ignition system
  - Exhaust gas recirculation
2. The following parts are also considered emission-related components for exhaust emissions:
  - After-treatment devices
  - Crankcase ventilation valves
  - Sensors
  - Electronic control units
3. The following components are considered emission-related components for evaporative emissions:
  - Fuel tank
  - Fuel cap
  - Fuel line
  - Fuel line fittings
  - Clamps
  - Pressure relief valves
  - Control valves
  - Control solenoids
  - Electronic controls
  - Vacuum control diaphragms
  - Control cables
  - Control linkages
  - Purge valves
  - Vapor hoses
  - Liquid/vapor separator
  - Carbon canister
  - Canister mounting brackets
  - Carburetor purge port connector
4. Emission-related components also include any other part whose only purpose is to reduce emissions or whose failure will increase emissions without significantly degrading engine/equipment performance.

\*As related to the evaporative emission control system

## LIMITED APPLICABILITY

As a certifying manufacturer, BRP may deny emission-related warranty claims for failures that have been caused by the owner's or operator's improper maintenance or use, by accidents for which the manufacturer has no responsibility, or by acts of God. For example, an emission-related warranty claim need not be honored for failures that have been directly caused by the operator's abuse of the engine/equipment or the operator's use of the engine/equipment in a manner for which it was not designed and are not attributable to the manufacturer in any way.

### **BRP US INC. LIMITED WARRANTY FOR ROTAX® INBOARD JET PROPULSION SYSTEMS SOLD OUTSIDE THE UNITED STATES AND CANADA**

- For a copy of the Limited Warranty, see your Bombardier Recreational Products ("BRP") distributor/dealer authorized to distribute Rotax® Inboard Jet Propulsion Systems in the country in which the sale occurs.
- If further assistance is required, please contact the affiliate of BRP where the Product was registered for warranty.

#### **ASIA PACIFIC**

Australia, New Zealand  
T: 612.9794.6600

Japan  
T: 814.4200.1431

China, Taiwan, Singapore, Malaysia  
T: 52.2431.2245

Philippines, India, Polynesia, all other Asian countries and the Pacific Islands  
T: 852.2431.2245

#### **LATIN AMERICA**

Brazil  
T: 55.19.37.168600

The Caribbean Islands, all Central American countries and all other South American countries  
T: 95.48.46.1442

**RUSSIA, CENTRAL AND EASTERN EUROPE, COMMONWEALTH OF INDEPENDENT STATES (CEE-CIS)**  
Russia, Turkey, Romania, Hungary, Poland, Slovenia and all other Eastern European countries  
T: 420.232.007.000

**WESTERN EUROPE, MIDDLE EAST AND AFRICA (WEMEA)**  
France  
T: 334.4294.2500

Spain  
T: 349.3636.1097

Germany, Austria, Italy, Switzerland  
T: 492.1747.8360

United Kingdom, Ireland, Scotland  
T: 441.2028.12100

Belgium, Netherlands, Luxembourg and all African countries  
T: 329.218.2600

Mexico  
T: 33.22.82.7700

All Middle Eastern countries  
T: 971.488.72121

**SCANDINAVIA**

Finland, Norway, Sweden  
T: 358.1632.08.132

\* Systems sold in Canada are distributed and serviced by Bombardier Recreational Products Inc.

® Registered trademark of Bombardier Recreational Products Inc. or its affiliates.

© 2017 BRP US Inc. All rights reserved.  
Limited Warranty 2017

## CALIFORNIA EMISSION CONTROL WARRANTY STATEMENT FOR ROTAX® INBOARD JET PROPULSION SYSTEMS

For California, your boat has a special environmental label required by the California Air Resources Board located to the port side of the hull, either to the right or left and in close proximity to the required location of the California Assigned Vessel Number. The label has 4 stars. A hang tag, provided with your boat, describes the meaning of the star rating system. Dealer located in California has the responsibility of displaying the hang-tag on a visible location to each boat equipped with Rotax® Inboard Jet Propulsion System and to identify the corresponding Star Label.

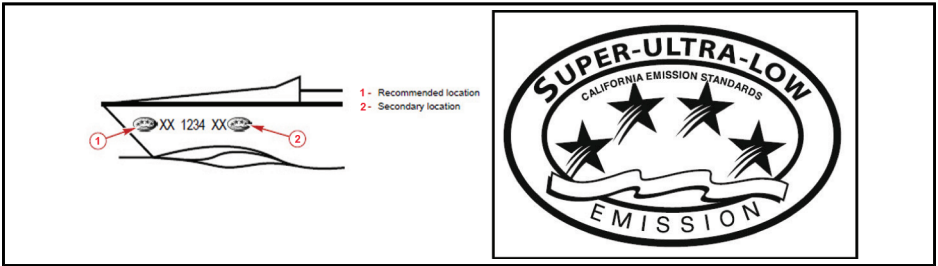

### TYPICAL

1. Recommended location
2. Secondary location

# CALIFORNIA EMISSION CONTROL WARRANTY STATEMENT FOR ROTAX® INBOARD JET PROPULSION SYSTEMS

## The Star Label means Cleaner Marine Engines

This engine has been certified as:



**The Symbol for Cleaner Marine Engines:**

**Cleaner Air and Water**

For a healthier lifestyle and environment.

**Better Fuel Economy**

Burns up to 30-40 percent less gas and oil than conventional carbureted two-stroke engines, saving money and resources.

**Longer Emission Warranty**

Protects consumer for worry free operation.

219902678



**One Star-Low emission**

The one-star label identifies personal watercraft, outboard, sterndrive and inboard engines that meet the Air Resources Board's Personal Watercraft and Outboard marine engine 2001 exhaust emission standards. Engines meeting these standards have 75% lower emissions than conventional carbureted two-stroke engines. These engines are equivalent to the U.S. EPA's 2006 standards for marine engines.



**Two Stars-Very Low emission**

The two-star label identifies personal watercraft, outboard, sterndrive and inboard engines that meet the Air Resources Board's Personal Watercraft and Outboard marine engine 2004 exhaust emission standards. Engines meeting these standards have 20% lower emissions than One Star - Low-Emission engines.



**Three Stars-Ultra Low emission**

The three-star label identifies engines that meet the Air Resources Board's Personal Watercraft and Outboard marine engine 2008 exhaust emission standards or the Sterndrive and Inboard marine engine 2003 exhaust emission standards. Engines meeting these standards have 65% lower emissions than One Star - Low Emission engines.



**Four Stars-Super Ultra Low emission**

The four-star label identifies engines that meet the Air Resources Board's Sterndrive and Inboard marine engine 2009 exhaust emission standards. Personal Watercraft and Outboard marine engines may also comply with these standards. Engines meeting these standards have 90% lower emissions than One Star - Low Emission engines.

219902678

HANG TAG

## THE SYMBOL FOR CLEANER MARINE ENGINES

### The Star Label means Cleaner Marine Engines

This engine has been certified as:



#### The Symbol for Cleaner Marine Engines.

##### Cleaner Air and Water

For a healthier lifestyle and environment.

##### Better Fuel Economy

Burns up to 30-40 percent less gas and oil than conventional carbureted two-stroke engines, saving money and resources.

##### Longer Emission Warranty

Protects consumer for worry free operation.

## Cleaner Air and Water

For a healthier lifestyle and environment.

## Better Fuel Economy

Burns up to 30-40 percent less gas and oil than conventional carbureted two-stroke engines, saving money and resources.

## Longer Emission Warranty

Protects consumer for worry free operation.

## One Star — Low Emission

The one-star label identifies personal watercraft, outboard, stern drive and inboard engines that meet the Air Resources Board's Personal Watercraft and Outboard marine engine 2001 exhaust emission standards. Engines meeting these standards have 75% lower emissions than conventional carbureted two-stroke engines. These engines are equivalent to the U.S. EPA's 2006 standards for marine engines.

## Two Stars — Very Low Emission

The two-star label identifies personal watercraft, outboard, stern drive and inboard engines that meet the Air Resources Board's Personal Watercraft and Outboard marine engine 2004 exhaust emission standards. Engines meeting these standards have 20% lower emissions than One Star - Low-Emission engines.

## Three Stars — Ultra Low Emission



The three-star label identifies engines that meet the Air Resources Board's Personal Watercraft and Outboard marine engine 2008 exhaust emission standards or the Stern Drive and Inboard marine engine 2003 exhaust emission standards. Engines meeting these standards have 65% lower emissions than One Star – Low Emission engines.

### **Four Stars — Super Ultra Low Emission**

The four-star label identifies engines that meet the Air Resources Board's Stern Drive and Inboard marine engine 2009 exhaust emission standards. Personal Watercraft and Outboard marine engines may also comply with these standards. Engines meeting these standards have 90% lower emissions than One Star – Low Emission engines.

For more information:

Cleaner Watercraft — Get the Facts

1-800-END-SMOG

[www.arb.ca.gov](http://www.arb.ca.gov)

### **Your Emission Control Warranty Rights And Obligations**

The California Air Resources Board and BRP US Inc. ("BRP") are pleased to explain the emission control system warranty for your Rotax® Inboard Jet Propulsion System. In California, new boat engines must be designed, built and equipped to meet the State's stringent anti-smog standards. BRP must warrant the emission control system on your boat engine for the period of time listed below provided there has been no abuse, neglect or improper maintenance of your engine.

Your emission control system may include parts such as the fuel injection system, the ignition system and catalytic converter. Also included may be hoses, belts, connectors and other emission related assemblies.

Where a warrantable condition exists, BRP will repair your boat engine at no cost to you including diagnosis, parts and labor provided that such work is performed by an authorized BRP dealer.

## Manufacturers Limited Warranty Coverage

This emission limited warranty covers Rotax® Inboard Jet Propulsion Systems certified and produced by BRP for sale in California, that are originally sold in California to a California resident or subsequently warranty registered to a California resident. The BRP limited warranty conditions for Rotax® Inboard Jet Propulsion Systems are still applicable to these models with the necessary modifications. Select emission control parts of your Rotax® Inboard Jet Propulsion System are warranted from the date of delivery to the first retail consumer for a period of 36 months, or for 480 hours of use, whichever occurs first. However, warranty coverage based on the hourly period is only permitted for boats equipped with the appropriate hour meters or their equivalent. If any emission-related part on your engine is defective under warranty, the part will be repaired or replaced by BRP.

### Parts Covered For Boats Equipped With Rotax® Inboard Jet Propulsion Systems:

Throttle Position Sensor	Air Intake Adapter
Intake Manifold Air Pressure Sensor	Spark Plug
Intake Manifold Air Temperature Sensor	Ignition Coils
Engine Temperature Sensor	Air Box
Knock Sensor	Intake and Exhaust Valve & Seals
Engine Control Module	Crankcase Ventilation Valve
Throttle Body	Throttle Body Seal
Fuel Rail	Wire Harness and Connectors
Fuel Injectors	Intake Manifold
Fuel Pressure Regulator	Intake Manifold Seal
Fuel Pump	Fuel Filter
Oxygen Sensor	Supercharger
Catalytic Converter	

The emission warranty covers damage to other engine components that is caused by the failure of a warranted part.

---

## **Parts Covered For Boats Equipped With Rotax® Inboard Jet Propulsion Systems:**

---

The BRP Operators Manual provided contains written instructions for the proper maintenance and use of your Inboard Jet Propulsion System. All emission warranty parts are warranted by BRP for the entire warranty period of the engine, unless the part is scheduled for replacement as required maintenance in the Operators Manual.

Emission warranty parts that are scheduled for replacement, as required maintenance, are warranted by BRP for the period of time before the first scheduled replacement date for that part. Emission warranty parts that are scheduled for regular inspection, but not regular replacement, are warranted by BRP for the entire warranty period of the engine. Any emission warranty part repaired or replaced under the terms of this warranty statement is warranted by BRP for the remainder of the warranty period of the original part. All parts replaced under this limited warranty become the property of BRP. Maintenance receipts and records should be transferred to each subsequent owner of the boat.

### **OWNER'S WARRANTY RESPONSIBILITIES**

As the owner of a boat with a Rotax® Inboard Jet Propulsion System, you are responsible for the performance of the required maintenance listed in your Operators Manual. BRP recommends that you retain all receipts covering maintenance your boat engine, but BRP cannot deny warranty solely for the lack of receipts or your failure to ensure the performance of all scheduled maintenance. As the owner of a Rotax® Inboard Jet Propulsion System, you should however be aware that BRP may deny you warranty coverage if your engine(s) or a part has failed due to abuse, neglect, improper maintenance or unapproved modifications. You are responsible for presenting your engine to an authorized BRP Dealer as soon as a problem exists. The warranty repairs will be completed in a reasonable amount of time, not to exceed 30 days. If you have any questions regarding your warranty rights and responsibilities, or for the name and location of the nearest authorized BRP Dealer, you should contact the Customer Assistance Center at 1-844-345-4277.

---

# CORROSION WARRANTY STATEMENT

## BRP US INC. LIMITED CORROSION WARRANTY FOR ROTAX® INBOARD JET PROPULSION SYSTEMS

**What is covered:** BRP US Inc.\* (“BRP”) warrants that each new ROTAX® Inboard Jet Propulsion System (“Product”) that are incorporated into boats made by authorized manufacturers and sold by authorized distributors or dealers will not be rendered inoperative as a direct result of corrosion for the period of time described below.

**Duration of coverage:** This limited corrosion warranty will be in effect from the date of delivery to the first retail customer or the date the Product is first put to use, whichever comes first, for a period of on (1) year. The repair or replacement of parts, or the performance of service under this limited corrosion warranty, does not extend the life of this limited corrosion warranty beyond its original expiration date. Unexpired warranty coverage can be transferred to a subsequent (non-commercial use) purchaser upon proper registration of the Product.

## WARRANTY INFORMATION

### Conditions required for warranty coverage:

This limited corrosion warranty is available only if each of the following conditions has been fulfilled:

- The Product must be purchased as new and unused by its first owner from an authorized Product dealer (“Dealer”) authorized to distribute Products in the country which the sale occurred;
- The BRP specified pre-delivery inspection process must be completed and documented and signed by the Dealer and the purchaser (“Owner”);
- The Product must have undergone proper registration by a Dealer;
- The Product must be purchased in the country in which the Owner resides;
- Corrosion prevention devices specified in the Operator’s Manual must be in use on the boat; and
- Routine maintenance outlined in the Operator’s Manual must be timely performed (including, without limitation, the replacement of sacrificial anodes, use of specified lubricants, and paint touch-up of nicks and scratches) in order to maintain warranty coverage. BRP reserves the right to make warranty coverage contingent upon proof of proper maintenance by a Dealer.

**Exclusions:** The following are not warranted under any circumstances:

---

- Corrosion damage caused by stray electrical currents (e.g. on-shore power connections, nearby boats);
- Damage caused by improper application of copper based anti-fouling paints;
- Electrical system corrosion;
- Corrosion resulting from damage;
- Corrosion which causes purely cosmetic damage;
- Abuse or improper service;
- Corrosion to accessories, instruments, steering systems;
- Damage due to marine growth;
- Replacement parts (parts purchased by Owner); or
- Products used in commercial application or use. Commercial application or use is defined as any work or employment related to use of the Product, or any use of the Products which generates income, for any part of the warranty period, even if the Product is only occasionally used for such purposes.

If anti-fouling protection is required, Bis (tributyltin) adipate ("TBTA") base anti-fouling paints are recommended on ROTAX® engine boating applications. In areas where TBTA base paints are prohibited by law, copper base paints can be used on the hull and transom. Do not apply paint to the Product. In addition, care must be taken to avoid an electrical interconnection between the Product and the paint.

**What to do to obtain warranty coverage:** The registered Owner must notify an authorized Dealer within seven (7) days of the appearance of a defect. BRP is not responsible for damages caused by the use of a Product after the appearance of a defect. Owner must bring Product, including any defective part therein, to Dealer promptly after the appearance of the defect, and in any event, within the warranty period, and must provide Dealer with reasonable opportunity to repair the defect. The expenses of transporting Product to and from Dealer for warranty service are to be borne by the Owner.

If the Product has not previously been registered, the Owner may also be required to present proof of qualifying purchase to Dealer for warranty repairs. Owner is required to sign the repair work order prior to the start of the repair in order to validate the warranty repair.

All parts replaced under this warranty become the property of BRP.

**What BRP will do:** BRP's sole and exclusive obligation under this limited corrosion warranty is limited to, at BRP's option, repairing a corroded part, replacing such part or parts with new genuine or ROTAX® certified remanufactured parts, or refunding the purchase price of the Product. BRP reserves the right to improve or modify Products from time to time without assuming an obligation to modify Products previously manufactured

**TRANSFER:** If the ownership of the Product is transferred during the limited warranty coverage period, this limited warranty, subject to its terms and conditions, shall also be transferred and be valid for the remaining coverage period provided that BRP is notified of such transfer of ownership in one of the following ways:

- The former Owner contacts BRP (at the phone number provided below);
- A Dealer transfers ownership using the BRP BOSSWeb™ system; or
- BRP or a Dealer receives such other proof, acceptable to BRP, that the former Owner agreed to the transfer of ownership, in addition to the coordinates of the new Owner.

## CONSUMER ASSISTANCE

In the event of a controversy or dispute in connection with this BRP limited corrosion warranty, BRP recommends that you first try to resolve the issue at the dealership level by discussing the issue with the Dealer's service manager or owner.

If further assistance is required, please contact BRP US Inc., Attn: Consumer Support, P.O. Box 597, Sturtevant, WI 53177, Telephone: +1 844 345-4277.

\* Engines sold in Canada are distributed and serviced by Bombardier Recreational Products Inc.

®™ Registered trademark or trademark of Bombardier Recreational Products Inc. or its affiliates.

© 2018 BRP US Inc. All rights reserved.

# **INSPECTIONS AND MAINTENANCE**

# PRE-RIDE INSPECTION

## ⚠ WARNING

The pre-ride inspection is very important before operating the boat. Bring all safety equipment required by local laws. Perform a pre-ride inspection before each ride to detect potential problems during operation. The pre-ride inspection can help you monitor wear and deterioration before they become a problem. Correct any problems that you discover to reduce the risk of a breakdown or accident.

For more detailed information on these items, refer to the applicable sections.

## ⚠ WARNING

Engines must be off and the tether cord removed from engine cut-off switch except where specified otherwise.

### PRE-RIDE CHECKLIST WHEN BOAT IS TRAIERED TO WATERWAY (RECOMMENDED CHECKS)

#### SUMMARY

	ITEM	OPERATION	CHECK
BOAT ON TRAILER	Fuel tank	Refill	
	Hull and deck	Inspect for damage	
	Jet pump water intake	Inspect/clean	
	Bilge	Check for abnormal water presence in bilge and ensure drain plug is properly secured	
	Engine compartment	Verify for leaks or gasoline vapor odor. Verify fuel system components integrity.	
	Throttle lever	Check operation	
	Shift lever	Check operation	
	Steering	Check operation	



<b>PRE-RIDE CHECKLIST WHEN BOAT IS TRAILERED TO WATERWAY (RECOMMENDED CHECKS)</b>			
	Bilge blower	Turn ON bilge blower for 5 minutes to ventilate bilge	
	Instrumentation	Check operation	
	Mandatory safety boating equipment	Ensure all required safety equipment is on board	
	Storage compartment covers	Ensure they are closed and latched	
	Navigation lights	Check operation	
	Engine(s) start/stop switch	Check operation for starting and stopping engine(s)	
	Engine cut-off-switch	Check if engine can be stopped by pulling off the tether cord from the engine cut-off-switch.	
	Removable cushions	Removable cushions securely fastened or stowed.	
BOAT IN WATER (ENGINE STARTED)	Throttle lever	Check operation	
	Shift lever	Check operation	
	Steering	Check operation	

# PRE-RIDE CHECKLIST

PRE-RIDE CHECKLIST WHEN BOAT IS MOORED TO A DOCK			
SUMMARY			
	ITEM	OPERATION	CHECK
BOAT ON TRAILER	Fuel tank	Refill	
	Hull and deck	Inspect for damage	
	Jet pump water intake	Inspect/clean	
	Bilge	Check for abnormal water presence in bilge and ensure drain plug is properly secured	
	Engine compartment	Verify for leaks or gasoline vapor odor. Verify fuel system components integrity.	
	Throttle lever	Check operation	
	Shift lever	Check operation	
	Steering	Check operation	
	Bilge blower	Turn ON bilge blower for 5 minutes to ventilate bilge	
	Instrumentation	Check operation	
	Mandatory safety boating equipment	Ensure all required safety equipment is on board	
	Storage compartment covers	Ensure they are closed and latched	
	Navigation lights	Check operation	
	Engine(s) start/stop switch	Check operation for starting and	

**PRE-RIDE CHECKLIST WHEN BOAT IS MOORED TO A DOCK**

		stopping engine(s)	
	Engine cut-off-switch	Check if engine can be stopped by pulling off the tether cord from the engine cut-off-switch.	
	Removable cushions	Removable cushions securely fastened or stowed.	
BOAT IN WATER (ENGINE STARTED)	Throttle lever	Check operation	
	Shift lever	Check operation	
	Steering	Check operation	

---

# MAINTENANCE SCHEDULE

The boat should be serviced as per the maintenance schedule.

A repair shop or person the owner's choosing may maintain, replace, or repair emission control devices and systems. These instructions do not require components or service by BRP or authorized Rotax® Jet Propulsion dealers. Although an authorized Rotax® Jet Propulsion dealer has an in-depth technical knowledge and tools to service the Rotax® Jet Propulsion System, the emission-related warranty is not conditioned on the use of an authorized Rotax® Jet Propulsion dealer or any other establishment with which BRP has a commercial relation-ship. For emission-related warranty claims, BRP is limiting the diagnosis and repair of emission-related parts to the authorized Rotax® Jet Propulsion dealers. For more information, please refer to the US EPA EMISSION RELATED WARRANTY contained herein. Proper maintenance is the owner's responsibility. A warranty claim may be denied if, among other things, the owner or operator caused the problem through improper maintenance or use.

You must follow the instructions for fuel requirements in the fueling section of this manual. Even if gasoline containing greater than ten volume percent ethanol is readily available, the US EPA issued a prohibition against the use of gasoline containing greater than 10 vol% ethanol that applies to this vehicle. The use of gasoline containing greater than 10% ethanol with this engine may harm the emission control system.

The schedule should be adjusted according to operating conditions and use. Intensive use of engine will require greater frequency of inspection and maintenance.

The maintenance schedule does not exempt the pre-ride inspection.

 **WARNING**

**Failure to properly maintain the boat according to the maintenance schedule can make it unsafe to operate.**

TO BE PERFORMED BY				
EVERY 200 HOURS OR 2 YEARS				
EVERY 100 HOURS OR PRE-SEASON				
FIRST 50 HOURS				
PART/TASK				
<b>ENGINE</b>				
Engine oil and filter	R	R <sup>(1)</sup>		RS
Rubber mounts	I	I		O, RS
Corrosion protection <sup>(3)</sup>		L <sup>(4)</sup>		O
<b>EXHAUST SYSTEM</b>				
Exhaust system (including hoses, fasteners, components and leaks)	I	I, C		O, RS
Exhaust system flushing		I, C <sup>(5)</sup>		O
<b>COOLING SYSTEM</b>				
Hose and fasteners	I	I		O, RS
Coolant	I		R	O, RS
<b>FUEL SYSTEM</b>				
Throttle body	I	I		O, RS
Fuel lines, connections, pressure relief valve and fuel system leak test	I	I		RS
<b>ENGINE MANAGEMENT SYSTEM</b>				
Fault Codes	I	I		O, RS
<b>AIR INTAKE SYSTEM</b>				
Air filter		I, <sup>(6)</sup>		RS
<b>ELECTRICAL SYSTEM</b>				
Test the engine cut-off switch and the monitoring beeper at first 50 hours and every 100 hours or once a year	I	I		

Spark plugs	I	I	R	RS
Ignition coils	I	I, L <sup>(9)</sup>		RS
Electrical connections and fastening (visual inspection)	I	I		RS
<b>STEERING SYSTEM</b>				
Steering cable and connections	I <sup>(4)</sup>	I		O
Steering nozzle bushings	I <sup>(4)</sup>	I		O, RS
<b>PROPULSION SYSTEM</b>				
Carbon ring and rubber boot (drive shaft)	I	I		RS
Shifter system, cable and connections	I <sup>(4)</sup>	I		O, RS
Reverse gate	L <sup>(4)</sup>	L		RS
Drive shaft / impeller splines		I, L		RS
Drive shaft		L <sup>(7)</sup>		RS
Impeller boot	I	I		RS
Impeller shaft seal		I	R <sup>(2)</sup>	RS
Impeller wear ring clearance	I	I		RS
Sacrificial anode		I <sup>(8)</sup>		O
<b>HULL AND BODY</b>				
Ride plate and water intake grate		I		O
<p>A: ADJUST                      1) At storage period or after 100 hours of use whichever comes first  C: CLEAN                        2) Replace at 200 hours of use, irrespective of the number of years  I: INSPECT                      3) Spray an anti-corrosion lubricant on metallic components in engine compartment  L: LUBRICATE                 4) Every 10 hours in salt water  R: REPLACE                    5) Daily flushing in salt water or foul water use  RS: REPAIR SHOP             6) Replace if required  O: OPERATOR                 7) Lubricate for corrosion protection     8) Inspect each month and change when necessary     9) No applicable for 300 ACE models</p>				

# MAINTENANCE PROCEDURES

## GENERAL

This section includes instructions for basic maintenance procedures.

### **WARNING**

Turn off the engine and follow these maintenance procedures when performing maintenance. If you do not follow proper maintenance procedures you can be injured by hot parts, moving parts, electricity, chemicals or other hazards.

### **WARNING**

Should removal of a locking device be required (e.g. lock tabs, self-locking fasteners, etc.), always replace it with a new one.

### **CAUTION**

Some components in the engine compartment may be very hot.

## RECOMMENDED ENGINE OIL FOR ROTAX® 4-TEC 150 AND ROTAX® 4-TEC 150, 200, 250 ENGINES and ROTAX ACE 300 ENGINES

Use XPS™ 4- STROKE SYNTH. BLEND OIL (SUMMER), P/N 460787.

If the recommended XPS engine oil is not available, use a 5W40 or 10W40 engine oil meeting the requirements for API service classification SM, SL or SJ. Always check the API service label certification on the oil container, it must contain at least one of the above standards.

## ENGINE OIL LEVEL

### **NOTICE**

These engines have been developed and validated using the BRP XPS Synthetic blend oil. BRP recommends the use of its XPS Synthetic blend oil at all times. If the recommended XPS engine oil is not available, use a 10W40 mineral engine oil compatible with wet clutches. Damages caused by oil which is not suitable for the engine may not be covered by the BRP limited warranty.

### **NOTICE**

**NEVER** use fully synthetic oil. This would impair the proper operation of the supercharger clutch. Do not add any additives to the recommended oil. Mineral oils for API service classification SM contain additives (friction modifiers) that may cause inappropriate slippage of the supercharger and eventually lead to premature wear.

### **NOTICE**

Check level frequently and refill if necessary. Operating the engines with improper oil levels may severely damage engines.

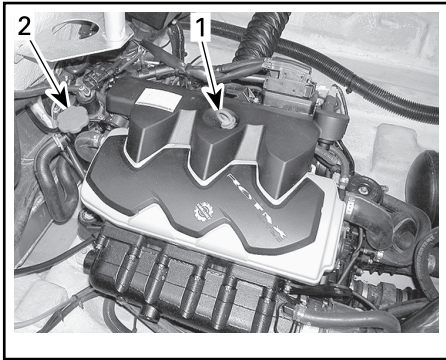

TYPICAL

1. Dipstick
2. Oil cap

**IMPORTANT:** Boat must be leveled. Oil level can be checked either with boat in water or out of water.

**IF THE BOAT IS OUT OF THE WATER**

If the boat is out of the water and on a trailer, block the wheels and raise the bow slightly with the trailer jack (if so equipped) until the bumper rail is level.

Install a garden hose to the flushing connector. Refer to EXHAUST SYSTEM FLUSHING.

**NOTICE**

Never run engine without supplying water to the exhaust systems when boat is out of water. Failure to supply water to the exhaust systems may severely damage exhaust systems.

**NOTICE**

Never run engine longer than 2 minutes. Drive line seals have no cooling when boat is out of water.

**IF THE BOAT IS IN OR OUT OF THE WATER**

It is of the utmost importance to follow this procedure in order to obtain an

accurate reading of the engine oil level.

**CAUTION**

Engine oil may be hot. Certain components in the engine compartment may be very hot. Direct contact may result in skin burn.

1. Ensure engine is at normal operating temperature.
2. Let engine idle for 30 seconds before stopping
3. Stop engine
4. Wait at least 30 seconds
5. Pull dipstick out and wipe clean

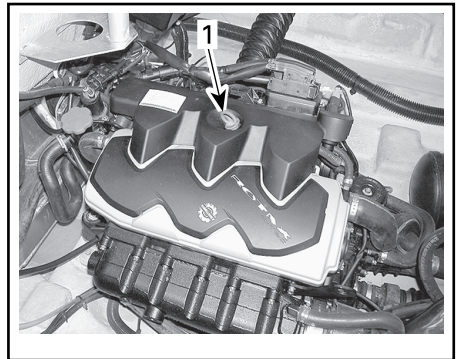

TYPICAL

1. Dipstick
6. Reinstall dipstick, push in completely
7. Remove dipstick and read oil level. It should be between marks.

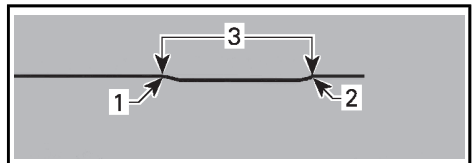

8. If needed, add oil up to have the level between marks as required.
9. To add oil, unscrew oil cap. Place a funnel into the opening and add the recommended oil to the proper level. Do not overfill.
10. Properly reinstall oil cap and dipstick.



11. If you have 2 inboards: Repeat the procedure on the other engine.
12. Wipe off any oil spillage that may have occurred during this procedure.

## ENGINE COOLANT

### Recommended Engine Coolant

Always use ethylene-glycol antifreeze containing corrosion inhibitors specifically for internal combustion aluminum engines.

#### ENVIRONMENTAL NOTE

When available, it is recommended to use biodegradable antifreeze compatible with internal combustion aluminum engines. This will contribute to protecting the environment.

Cooling system must be filled with BRP Pre-mixed Coolant, P/N 460835, or with a water and antifreeze solution (50% distilled water, 50% antifreeze).

Refer to an authorized Rotax® Jet Propulsion dealer.

#### ENGINE COOLANT LEVEL

With boat on a level surface, coolant should be between MIN. and MAX. level marks for each coolant reservoir when each engine is cold.



1. Level between marks when engine is cold

#### ⚠ WARNING

**Check coolant level with cold engine. Never add coolant in cooling system when engine is hot.**

**IMPORTANT:** The boat is considered level when it is in water. When boat is on a trailer, block the wheels and raise the bow slightly with the trailer jack (if so equipped) until the bumper rail is level.

Add coolant to have the level between marks as required. Use a funnel to avoid spillage. Do not overfill.

Properly reinstall and tighten filler cap.

**IMPORTANT:** A cooling system that frequently requires coolant indicates leaks or engine problems. See an authorized Rotax® Jet Propulsion dealer.

## IGNITION COIL REMOVAL

#### NOTICE

**Do not remove the ignition coil before disconnecting the input connector or the wires may be damaged. Do not pry up ignition coil with a screwdriver to avoid damage.**

1. Disconnect ignition coil connector.

**IMPORTANT:** Twist ignition coil in both directions as you pull it up to ease removal.

2. Remove ignition coil from spark plug.
3. For 300 ACE engines, remove the ignition coil screws and then remove the ignition coil.

**IGNITION COIL LUBRICATION  
150, 200 and 250 ENGINES ONLY**

1. Pull rubber seal down.

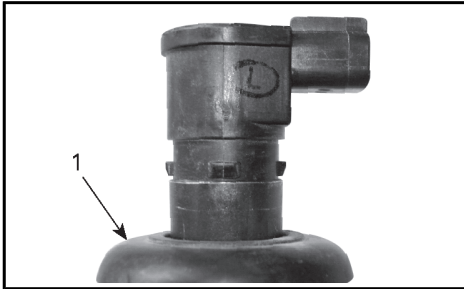

1. Rubber seal pulled down
2. Apply Dow Corning 111, P/N 460796, or equivalent to rubber seal seat as shown.

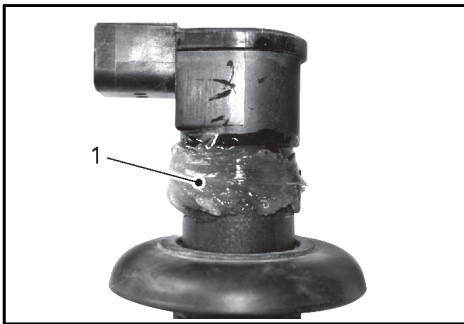

1. Apply product here
3. Pull rubber seal back on its seat making sure the tabs on the ignition coil and the slots in the seal properly match together.
4. Leave a ring of grease on top of the seal as shown to act as a water barrier. Wipe off the excess.

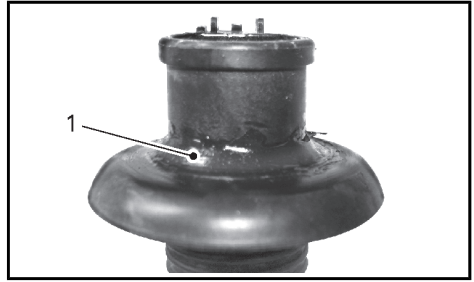

1. Correctly shaped excess of product
5. Apply DOW CORNING 111, P/N 460796, or equivalent on rubber seal contact area.

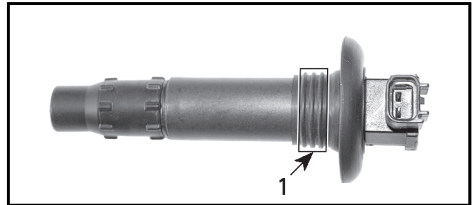

1. Apply product here

**IGNITION COIL INSTALLATION**

**IMPORTANT:** Prior to inserting the ignition coil on its spark plug, apply sealant as described in IGNITION COIL LUBRICATION.

1. Install coil in cylinder head hole.
2. Push the ignition coil down to securely install the coil in place over the spark plug.
3. Ensure the seal seats properly with top surface of engine valve cover.

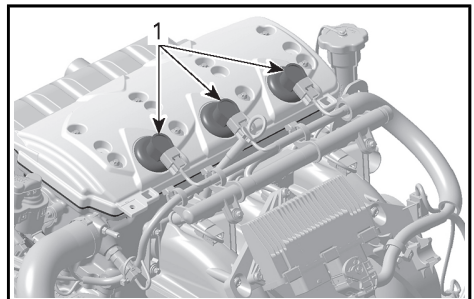

**TYPICAL**

1. Seal properly seated

4. For 300 ACE engines, install the ignition coil and secure using the ignition coil screws.
5. Tighten the screws to 9 N·m (6 lbf·ft.)

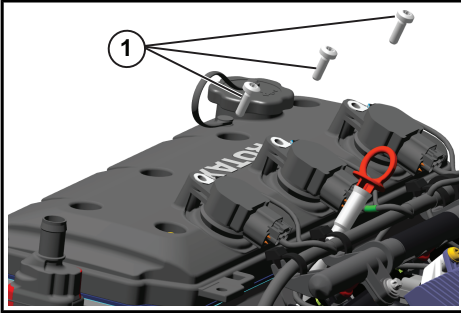

1. Ignition coil screws

## Anodes

Your boat is equipped with one or more sacrificial anodes that protect it from galvanic corrosion. Disintegration of the anode is normal and indicates it is working. Check each anode periodically. Replace anodes smaller than 2/3 their original size. See your dealer for replacements.

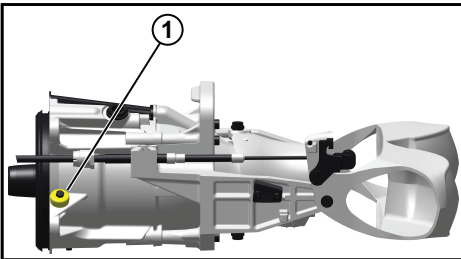

PORT SIDE

1. Anode

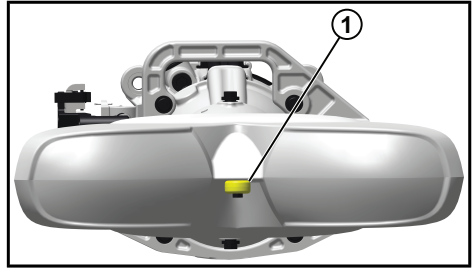

REVERSE GATE

1. Anode

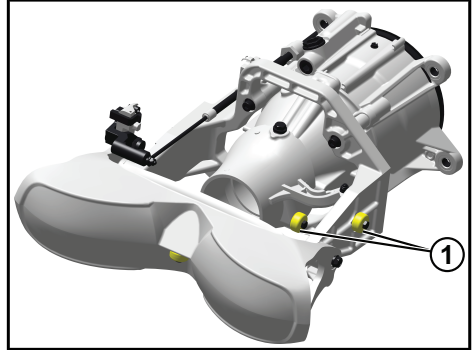

STARBOARD SIDE

1. Anodes

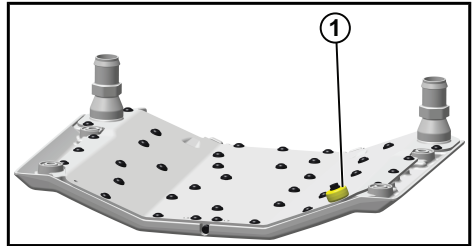

SINGLE ENGINE RIDE PLATE

1. Anode

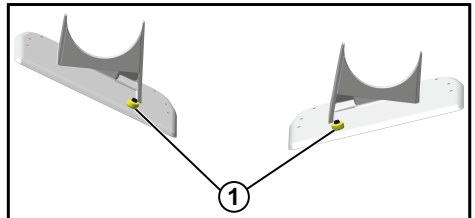

TWIN ENGINE RIDE PLATES

1. Anodes

Galvanic corrosion destroys underwater metal parts and can occur in

fresh or salt water; however, salt, brackish, and polluted waters will accelerate corrosion.

Metal-based anti-fouling paint on the boat and the use of improperly installed shore power in the area of your moored boat will also accelerate corrosion.

**NOTICE**

**NEVER paint the anode, its fasteners, or its mounting surface. Painting will reduce its corrosion protection.**

**Hull Finish**

The condition of your boat's bottom affects performance. marine growth or bottom painting may reduce speed and fuel efficiency.

For maximum performance, keep the boats' surface clean by rinsing it with fresh water and wiping it dry. Apply anti-corrosion spray to any surface subject to corrosion, but avoid the anti-corrosion anode(s).

**EXHAUST SYSTEM FLUSHING**

Flushing the exhaust system and intercooler of each engines with fresh water is essential to neutralize corroding effects of salt or other chemical products present in water. It will help to remove sand, salt, shells or other particles in water jackets and/or hoses.

**WARNING**

**Perform this operation in a well ventilated area.**

1. Clean jet pump by spraying water in its inlet and outlet and then apply a coating of XPS Lube, P/N 460786, or equivalent.

**WARNING**

**Perform this operation in a well ventilated area.**

2. Connect a garden hose to the connector located at the rear of boat on jet pump support. Do not open water tap at this time.

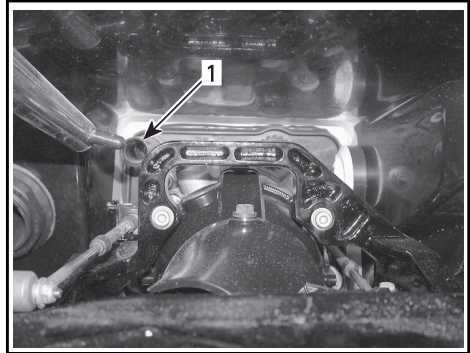

**TYPICAL**

1. Flushing connector

**IMPORTANT:** Use optional Flushing Adapter, P/N 460711, with a quick connect adapter to ease garden hose installation. A hose pincher is NOT required to flush engine.

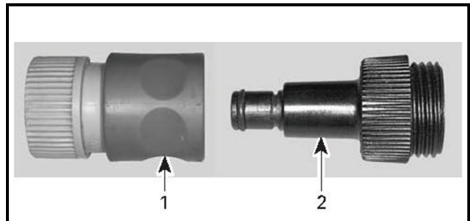

1. Quick connect adapter
2. Flushing connector adapter

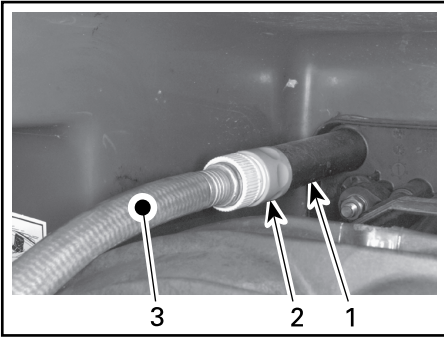

1. Flushing connector
  2. Quick connector adapter and flushing
  3. Garden hose
3. To flush, start engine then immediately open the water tap.

**⚠ CAUTION**

Certain components in the engine compartment may be very hot. Direct contact may result in skin burn. Do not touch any electrical parts or jet pump area when engine is running.

**NOTICE**

Never flush a hot engine. Always start the engine before opening the water tap. Open water tap immediately after engine is started to prevent overheating.

4. Run the engine about 20 seconds at a fast idle between 4000-5000 rpm.

**NOTICE**

Never run engine without supplying water to the exhaust system when the boat is out of water.

5. Ensure water flows out of jet pump while flushing. Otherwise, refer to an authorized Rotax Jet Propulsion dealer for servicing.

**NOTICE**

Never run engine longer than 2 minutes. Drive line seal has no cooling when boat is out of water.

6. Close the water tap, then stop the engine.

**NOTICE**

Always close water tap before stopping the engine.

**NOTICE**

Remove quick connect adapter after flushing operation (if used).

**POST OPERATION CARE**

Remove the boat from the water every day to prevent growth of marine organisms.

**NOTICE**

Failure to perform proper care such as boat rinsing, exhaust system flushing and anti-corrosion treatment when used in salt water will result in damage to the boat and its components.

**⚠ WARNING**

Allow engine to cool before performing any maintenance.

**EXHAUST SYSTEM FLUSHING**

The exhaust system should be flushed daily when boat is used in salt or foul water.

On supercharged models, the inter-cooler is flushed at the same time.

**ANTI-CORROSION TREATMENT**

To prevent corrosion, spray a corrosion inhibitor (salt water resistant) such as XPS Lube, P/N 460786, or

equivalent over metallic components in engine compartment.

Engine fogging should be done with XPS Lube, P/N 460786, or equivalent whenever the boat is to be stored for an extended period of time.

Apply Dielectric Grease, P/N 460781, (salt water resistant) on battery posts and cable connectors.

### NOTICE

**Never leave rags or tools in the engine compartment or in the bilge.**

### ADDITIONAL CARE FOR FOUL WATER OR SALT WATER USE

When the boat is operated in foul water and particularly in salt water, additional care must be taken to protect the boat and its components.

Rinse trailer and boat's hull/bilge area with fresh water.

Never use a high pressure washer to clean the bilge. USE LOW PRES-SURE ONLY (such as a garden hose). High pressure can cause damage to electrical or mechanical systems.

In coastal areas, special care should also be taken on stainless steel or chrome parts like grab handles, mooring cleats, fuel cap and navigation lights.

### STORAGE

It is recommended that the boat be taken to an authorized Rotax Jet Propulsion dealer, repair shop, or person of your choosing for proper storage but the following operations can be performed by you with a minimum of tools.

**IMPORTANT:** Leave the drain plug out during the storage period.

### JET PUMP CLEANING

Clean the jet pump by spraying water into the jet pump inlet and outlet. Apply a coating of XPS Lube, P/N 460786, or equivalent.

#### WARNING

**Always remove the tether cord cap from the engine cut-off switch to prevent unexpected engine starting before cleaning the jet pump area. The engine must not be running for this operation.**

### FUEL SYSTEM PROTECTION

XPS Fuel Stabilizer, P/N 460795, (or equivalent), can be added in fuel tank to prevent fuel deterioration and fuel system gumming. Follow stabilizer manufacturers instructions for proper use.

### NOTICE

**It is highly recommended to add fuel stabilizer at storage in order to maintain fuel system in good condition.**

### ENGINE OIL AND FILTER REPLACEMENT

The oil change and filter replacement may be performed by an authorized Rotax Jet Propulsion dealer, repair shop, or person of your choosing.

### INTERCOOLER DRAINING

It is important to expel any trapped water that may have accumulated from condensation in the intercooler of each engine.

1. Open the engine cover.
2. Ensure there is an alignment line drawn on the intercooler outlet hose. This will ensure the hose is not twisted or kinked upon installation.
3. Loosen the clamp retaining the intercooler outlet hose.

- Remove the intercooler outlet hose from the intercooler.

**IMPORTANT:** This hose feeds the inlet of the supercharger.

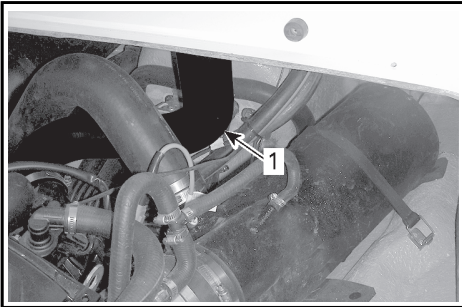

1. Intercooler outlet hose

- Start and rev the engine up to 4000 rpm several times.

**IMPORTANT:** Prevent air intake system from aspirating foreign objects which may cause severe engine damage.

- Stop engine.
- Reinstall the intercooler air outlet hose.

**IMPORTANT:** Properly align the intercooler air outlet hose upon installation to ensure proper operation.

**EXHAUST SYSTEM AND INTERCOOLER PROTECTION FLUSHING**

Expel water from the exhaust system and intercooler as follows:

Using the flushing connectors on the jet pump supports, inject pressurized air (around 689 kPa (100 psi)) into the system until there is no more water flowing from the jet pumps.

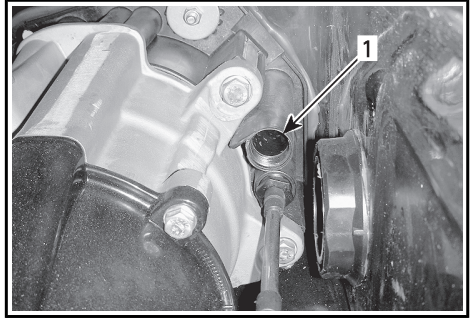

1. Flushing connector — location may differ

To ease the procedure, a custom hose can be assembled. See the following illustration.

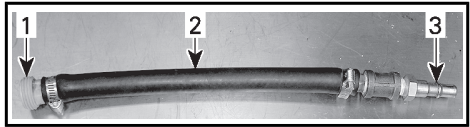

**TYPICAL**

- Flushing connector adapter (P/N 460711)
- Hose 13 mm (1/2 in.)
- Air hose male adapter

**NOTICE**

**Failure to drain the exhaust system may cause severe damage to intercooler and exhaust manifold.**

**OPTIONAL FLUSH KIT**

Remote Flush Kit, P/N 461478, is designed to work with the Rotax 1503 150 ECT, 200 ECT, 250 ECT and 300 ACE engines. Use the onboard flush kit to flush the exhaust system.

For the installation procedure refer to the instruction sheet provided with the kit.

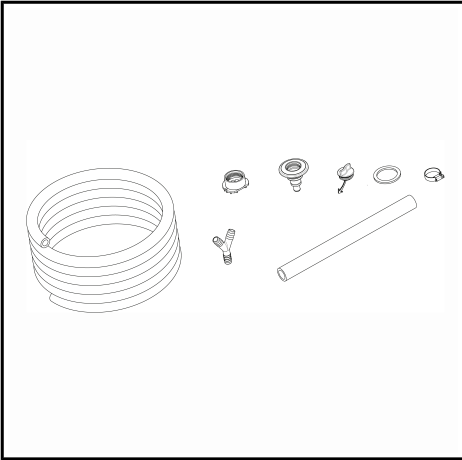

1. Remote flush kit P/N 461478

### ENGINE INTERNAL LUBRICATION

**IMPORTANT:** All engines, single or twin engine configurations, must be internally lubricated for the storage period.

1. Open the engine compartment lid.
2. Remove storage tray.
3. Remove dipstick.
4. Remove engine cover.
5. Reinstall dipstick.
6. Expel water from the exhaust system and intercooler as follows:
7. Remove ignition coils.
8. Remove spark plugs.

### NOTICE

Ensure there is no dirt in coil holes before removing the spark plugs. Otherwise, dirt would fall into cylinder and will damage the internal components.

**IMPORTANT:** After loosening the spark plugs, a coil may be used to remove the spark plugs. Simply bring the coil down to spark plug and “hook” it, then extract spark plug.

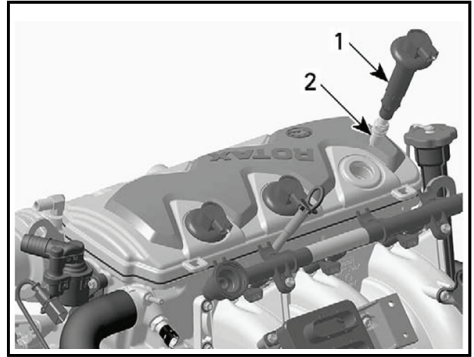

1. Ignition coil
2. Spark plug
9. Spray XPS Lube, P/N 460786, or equivalent, into spark plug holes.

**IMPORTANT:** To allow engine lubrication for storage, the DROWNED MODE can be activated to prevent fuel injection and ignition while cranking in order to lubricate the cylinder walls.

**IMPORTANT:** Ask a person to assist you for this operation.

10. To activate drowned mode, ensure both engines are OFF.

### WARNING

**Both engines must be stopped when using drowned mode to lubricate the engines.**

11. Install the tether cord on the engine cut-off switch.
12. Ensure the throttle/shifter lever is in the NEUTRAL position
13. Move the throttle accelerator sensor (TAS) to the wide open throttle (WOT) position.
14. Turn the ignition key to the ON position.

**IMPORTANT:** The ECM will allow engine cranking while inhibiting fuel injection and ignition. Do not crank the engine(s)

15. Ensure both engines are OFF.



16. Crank each engine a few turns to distribute the oil on the cylinder walls.
17. Release the TAS.
18. Turn the ignition key to the OFF position.
19. Apply Loc-Tite 767 Anti-Seize Lubricant, P/N 460791, onto the spark plug threads then install the spark plugs.
20. Lubricate and install the ignition coils.
21. Reinstall the engine cover until it snaps properly into place.
22. Install the oil dipstick.

**IMPORTANT:** It is recommended to fog the engine valves with XPS Lube, P/N 460786 or equivalent. Contact your authorized Rotax Jet Propulsion dealer.

**ENGINE COOLANT TEST**

If the antifreeze is not replaced, test the density.

The antifreeze replacement and a density test should be performed by an authorized Rotax Jet Propulsion dealer.

**NOTICE**

**Improper antifreeze density may allow freezing of the liquid in the cooling system if the boat is stored in an area where the freezing point is attained. This would seriously damage the engine.**

**BATTERY REMOVAL AND STORAGE**

For battery removal, cleaning and storage, contact your Rotax Jet Propulsion dealer.

**PRESEASON PREPARATION**

Maintenance preparation must be performed in conjunction with the maintenance schedule.

Ensure to perform all tasks included in the 100 hours or Pre-Season column.

Preseason maintenance preparation may be performed by an authorized Rotax Jet Propulsion dealer, repair shop, or person of your own choosing.

Though not required, it is recommended that an authorized Rotax Jet Propulsion dealer perform preseason maintenance preparation at the same time that any safety-related factory campaigns are performed by the authorized Rotax Jet Propulsion dealer.

**⚠ WARNING**

**Only perform procedures as detailed in the maintenance schedule. It is recommended that the assistance of an authorized Rotax® Jet Propulsion dealer be periodically obtained on other components and systems not covered in this Manual.**

**NOTICE**

**When component conditions seem less than satisfactory, replace using genuine BRP parts, or equivalents.**

**SPECIFICATIONS**

MODELS		150	200	250	300
<b>ENGINE</b>					
Engine type		Rotax 1503 4-TEC, 4-stroke Single Over Head Camshaft (SOHC)			ROTAX® 1603 ACE HO, 4-stroke, Single Over Head Camshaft (SOHC)
Number of engines		1, (2)			
Exhaust system		D-Sea-Bel sound reduction system. Water cooled/ water injected (open loop). Direct flow from jet pump			
Lubrication	Type	Dry sump (2 oil pumps). Replaceable oil filter. Water-cooled oil cooler			
	Oil type	Use XPS™ 4-STROKE SYNTH. BLEND OIL (SUMMER), P/N 460787	Use XPS™ 4- STROKE SYNTH. BLEND OIL , (P/N 460836), or a 10W40 mineral engine oil compatible with wet clutches (JASO MA certified oils).		
Number of cylinders/ engine		3			
Displacement/engine		1493.8 cm <sup>3</sup> (91 in <sup>3</sup> )			1 630.5 cm <sup>3</sup> (99.5 in <sup>3</sup> )
Induction type		Naturally aspirated	Supercharged/intercooled		
Declared Power <sup>(1)</sup>		106 kW @ 7500 RPM	152 kW @ 8000 RPM	179 kW @ 8000 RPM	217 kW @ 8000 RPM
<b>COOLING</b>					
Type		Liquid cooled. Closed system.			
Coolant		Use BRP Premixed Coolant, P/N 460835, or a blend of 50% ethylene-glycol antifreeze specially formulated for aluminum engines, with 50% distilled water			

MODELS		150	200	250	300
<b>ELECTRICAL</b>					
Magneto generator output		550 W @ 6000 RPM			
Ignition system type		DI (Digital Inductive)			IDI (Inductive Discharge Ignition)
Spark plug	Brand & Type	NGK, DCPR8E			NGK KR9E-G
	Gap	0.7 mm - 0.8 mm (0.028 in - 0.031 in)			
Starting system		Electric starter			
Engine RPM limiter setting <b>Non-ECT Models</b>		7550 RPM	8050 RPM	8050 RPM	8450 RPM
Engine RPM limiter setting <b>ECT Models</b>		7550 RPM	8050 RPM	8050 RPM	N.A.
<b>PROPULSION SYSTEM</b>					
Jet pump type		Liquid cooled. Closed system			
Jet pump grease		BRP Jet Pump Bearing Grease, P/N 460785			
Transmission		Crowned splines, direct drive			
Pivoting angle and direction (nozzle)		20°			
Minimum required water level for jet pumps		90cm (3 ft) underneath the lowest rear portion of hull			
<b>DIMENSIONS, WEIGHT AND LOADING CAPACITY</b>					
See documentation of hull manufacturer					
<b>CAPACITIES</b>					
Engine oil — oil change with filter		3 L (3.2 qt (U.S. liq.))			
Total engine oil capacity		5 L (5.3 qt (U.S. liq.))			
Engine cooling system		5.5 L (5.8 qt (U.S. liq.)) total			Varies by boat OEM

MODELS	150	200	250	300
Fuel tank	See documentation of hull manufacturer			
(1) Declared power as per ISO 8665 at propeller shaft				

**NOTE:**

BRP reserves the right to make changes in design and specifications and/or to make additions to, or improvements in its products without imposing any obligation upon itself to in-stall them on its products previously manufactured.

# **TROUBLESHOOTING GUIDELINES**

# TROUBLESHOOTING CHARTS

The following information is provided to help in diagnosing the probable source of simple troubles. You may be able to solve many of these problems rather quickly, but others may require the skills of a trained technician.

In such case, consult an authorized Rotax Jet Propulsion dealer, repair shop, or person of your own choosing for maintenance, repair, or replacement.

## BATTERY IS REGULARLY DISCHARGED

1. Check battery condition
  - Have the battery charged or replace by an authorized Rotax Jet Propulsion dealer
2. Loose battery connections
  - Check/clean/tighten
3. Check the charging system fuse
  - Replace fuse if necessary and have charging system checked by an authorized Rotax Jet Propulsion dealer

## WARNING

**See your authorized Rotax Jet Propulsion marine engine dealer to have the battery charged or replaced. Do not charge or boost the battery while installed in the engine compartment. Electrolyte is poisonous and capable of causing severe burns.**

## ENGINE DOES NOT TURN OVER

1. Refer to MONITORING SYSTEM.
  - Have the Battery charged or replaced by an authorized Rotax Jet Propulsion dealer, repair shop, or person of your own choosing for maintenance, repair, or replacement

## ENGINE WILL NOT START

1. Tether cord removed
  - Install safety lanyard over engine cut-off switch
2. Burnt fuse
  - Check fuse(s). See an authorized Rotax Jet Propulsion dealer, repair shop, or person of your own choosing for maintenance, repair, or replacement if problem is repetitive
3. Discharged battery
  - Have the battery charged or replaced by an authorized Rotax Jet Propulsion dealer, repair shop, or person of your own choosing for maintenance, repair, or replacement

**ENGINE WILL NOT START**

4. Battery connections, corroded or loose  
- Contact an authorized Rotax Jet Propulsion dealer, repair shop, or person of your own choosing for maintenance, repair, or replacement
5. Water flooded engine  
- Contact an authorized Rotax Jet Propulsion dealer, repair shop, or person of your own choosing for maintenance, repair, or replacement
6. Obstructed jet pump  
- Try to clean. Otherwise, refer to an authorized Rotax Jet Propulsion dealer, repair shop, or person of your own choosing for maintenance, repair, or replacement
7. Faulty engine management system  
- Seek service from an authorized Rotax Jet Propulsion dealer, repair shop, or person of your own choosing for maintenance, repair, or replacement.

**ENGINE TURNS SLOWLY**

1. Loose battery cable connections.  
- Check/clean/tighten
2. Discharged or weak battery  
- Have the battery charged or replaced by an authorized Rotax Jet Propulsion dealer, repair shop, or person of your own choosing for maintenance, repair, or replacement
3. Bad grounds  
- Refer to an authorized Rotax Jet Propulsion dealer, repair shop, or person of your own choosing for maintenance, repair, or replacement
4. Worn starter or related parts  
- Refer to an authorized Rotax Jet Propulsion dealer, repair shop, or person of your own choosing for maintenance, repair, or replacement

**ENGINE TURNS NORMALLY BUT WILL NOT START**

1. Fuel tank empty or water contaminated  
- Refill or siphon and fill with fresh fuel.
2. Fouled/defective spark plugs  
- Replace
3. Burnt fuse  
- Check fuse(s). See an authorized Rotax Jet Propulsion dealer, repair shop, or person of your own choosing for maintenance, repair, or replacement if problem is repetitive.
4. Engine management System Fault Detected (Check If Engine Pilot Lamp Is On)

**ENGINE TURNS NORMALLY BUT WILL NOT START**

- Seek service from an authorized Rotax Jet Propulsion dealer, repair shop, or person of your own choosing for maintenance, repair, or replacement.

**5. Faulty fuel pump**

- Seek service from an authorized Rotax Jet Propulsion dealer, repair shop, or person of your own choosing for maintenance, repair, or replacement.

**6. Cluster was replaced**

- If the cluster was replaced the security coding could have been executed improperly. Seek service from an authorized Rotax Jet Propulsion dealer, repair shop, or person of your own choosing for maintenance, repair, or replacement.

**ENGINE MISFIRES, RUNS IRREGULARLY****1. Fouled/defective/worn spark plugs**

- Check/clean/tighten

**2. Faulty ignition coil(s)**

- Seek service from an authorized Rotax Jet Propulsion dealer, repair shop, or person of your own choosing for maintenance, repair, or replacement.

**3. Fuel: Level too low, stale or water contaminated**

- Siphon and/or refill

**4. Clogged injectors**

- Seek service from an authorized Rotax Jet Propulsion dealer, repair shop, or person of your own choosing for maintenance, repair, or replacement.

**5. Engine management system fault detected (check if engine pilot lamp is ON)**

- Seek service from an authorized Rotax Jet Propulsion dealer, repair shop, or person of your own choosing for maintenance, repair, or replacement.

**6. Operating the engine with bad gasoline or gasoline containing the improper octane level.**

- Seek service from an authorized Rotax Jet Propulsion dealer, repair shop, or person of your own choosing for maintenance, repair, or replacement.

**7. Leaking air intercooler and/or water in the intake.**

- Seek service from an authorized Rotax Jet Propulsion dealer, repair shop, or person of your own choosing for maintenance, repair, or replacement.



**ENGINE SMOKES**

1. Oil level too high  
- Seek service from an authorized Rotax Jet Propulsion dealer, repair shop, or person of your own choosing for maintenance, repair, or replacement.
2. Water ingestion, coolant leak or damaged cylinder head gasket  
- Seek service from an authorized Rotax Jet Propulsion dealer, repair shop, or person of your own choosing for maintenance, repair, or replacement.
3. Internal engine damage  
- Seek service from an authorized Rotax Jet Propulsion dealer, repair shop, or person of your own choosing for maintenance, repair, or replacement.

**NOTICE**

**If beeper emits a continuous beep, stop engine as soon as possible!**

**ENGINE OVERHEATING OR IMPROPER OIL PRESSURE  
(MONITORING BEEPER EMITS A CONTINUOUS BEEP)**

1. Check oil and coolant level  
- Refer to Maintenance Procedures. Refill if necessary.
2. Clogged jet pump water intake  
- Perform the Jet Pump and Water Intake and Impeller Cleaning.
3. Clogged exhaust system  
- Flush exhaust system

**NOTICE**

**If these actions do not correct the problem, discontinue use and seek service from an authorized Rotax Jet Propulsion dealer, repair shop, or person of your own choosing for maintenance, repair, or replacement.**

**ENGINE LACKS ACCELERATION OR POWER**

1. Jet pump water intake clogged  
- Clean. Refer to Jet Pump Water Intake And Impeller Cleaning Procedure.
2. Damaged impeller or worn out wear ring  
- Seek service from an authorized Rotax Jet Propulsion dealer, repair shop, or person of your own choosing for maintenance, repair, or replacement.
3. Faulty supercharger or intercooler  
- Seek service from an authorized Rotax Jet Propulsion dealer, repair shop, or person of your own choosing for maintenance, repair, or replacement.

**ENGINE LACKS ACCELERATION OR POWER****4. Supercharger clutch slipping**

- Seek service from an authorized Rotax Jet Propulsion dealer, repair shop, or person of your own choosing for maintenance, repair, or replacement.

**5. Weak spark**

- Refer to Troubleshooting Charts.

**6. Engine management system fault detected (check if engine pilot lamp is ON)**

- Seek service from an authorized Rotax Jet Propulsion dealer, repair shop, or person of your own choosing for maintenance, repair, or replacement.

**7. Clogged injectors**

- Seek service from an authorized Rotax Jet Propulsion dealer, repair shop, or person of your own choosing for maintenance, repair, or replacement.

**8. Low fuel pressure**

- Seek service from an authorized Rotax Jet Propulsion dealer, repair shop, or person of your own choosing for maintenance, repair, or replacement.

**9. Water in fuel**

- Siphon and replace

**BOAT CANNOT REACH TOP SPEED****1. Jet pump water intake clogged**

- Clean. Refer to Jet Pump Water Intake And Impeller Cleaning Procedure.

**2. Damaged impeller or worn-out wear ring**

- Replace. Refer to an authorized Rotax Jet Propulsion dealer, repair shop, or person of your own choosing for maintenance, repair, or replacement

**3. Faulty supercharger or intercooler**

- Seek service from an authorized Rotax Jet Propulsion dealer, repair shop, or person of your own choosing for maintenance, repair, or replacement.

**4. Check for a warning light and/or scrolling message, go to fault display page and look for an active Fault Code.**

- Seek service from an authorized Rotax Jet Propulsion dealer, repair shop, or person of your own choosing for maintenance, repair, or replacement.

**ABNORMAL NOISE FROM PROPULSION SYSTEM****1. Weeds or debris jammed around impeller**

- Clean. Refer to Jet Pump Water Intake And Impeller Cleaning Procedure.

**2. Damaged impeller or drive shaft**

- Seek service from an authorized Rotax Jet Propulsion dealer, repair shop, or person of your own choosing for maintenance, repair, or replacement

---

# MONITORING SYSTEM

## GENERAL

A system monitors the electronic components of the EMS (engine management system) and other components of the electrical system. When a fault occurs, it sends visual messages through the information center and/or audible signals through a beeper to inform you of a particular condition.

A fault code may also be recorded.

When a minor or transient fault occurs, the fault message and beeper will cease automatically if the condition that caused the fault does not exist anymore.

Releasing the throttle and letting the engine return to idle speed may allow normal operation to come back.

The electronic system will react differently depending on the fault type. In severe failure, the engine may not be allowed to be started. In other cases, the engine will operate in limp home mode (reduced speed).





When a fault occurs, Seek service from an authorized Rotax Jet Propulsion dealer, repair shop, or person of your own choosing for maintenance, repair, or replacement.

## PILOT LAMPS AND MESSAGE DISPLAY INFORMATION (TYPICAL)

Indicator lights (pilot lamps), located in the multifunction display, inform you of a system anomaly.

An indicator light may be accompanied by a scrolling message in the multifunction display. See table below for typical malfunction pilot lamps.

Other important items in the maintenance schedule are more difficult and require special tools.

PILOT LAMPS	BEEP	MESSAGE DISPLAY	DESCRIPTION
	Continue	HIGH TEMPERATURE	Engine or exhaust system overheating
	–	LOW or HIGH BATTERY VOLTAGE	Low/high battery voltage
	Continue	LOW OIL PRESSURE	Low oil pressure
	1 beep every 15 minutes	CHECK ENGINE or LIMP HOME MODE	Engine management system fault detected

### **NOTICE**

**If the monitoring beeper continuously sounds, stop engine as soon as possible.**

# **BREAK-IN AND SPECIAL PROCEDURES**

# BREAK-IN

## OPERATION

### NOTICE

Carefully follow the instructions in this section. Failure to do so may reduce the life and/or performance of the engines.

A break-in period of 3 hours is required before continuous operation at full throttle.

To achieve a good break-in, a maximum of 3/4 throttle should be observed, however, brief acceleration and speed variations contribute to a good break-in.

### NOTICE

Continued wide open throttle runs and prolonged cruising without speed variations should be avoided.

This can cause engine damage during the break-in period.

## ENGINE SPEED LIMITATION — 200, 250 SINGLE ENGINE MODELS AND ALL 300 MODELS ONLY

**IMPORTANT:** During the first three (3) hours of operation engine speed is limited by a break-in strategy programmed into the ECM.

Depending on the engine model and boat combination, maximum engine speed could be reduced to 7000 RPM or less.

Over the initial three hours of operation, the engine speed limitation is progressively reduced.

At the conclusion of the three hour run time, maximum engine speed is available.

## ENGINE SPEED LIMITATION — 200, 250 TWIN ENGINE MODELS ONLY

**IMPORTANT:** During the first six (6) hours of operation engine speed is limited by a break-in strategy programmed into the ECM.

Depending on the engine model and boat combination, maximum engine speed could be reduced to 7000 RPM or less.

Over the initial six hours of operation, the engine speed limitation is progressively reduced.

At the conclusion of the six hour run time, maximum engine speed is available.

## CLEANING

### JET PUMP WATER INTAKE AND IMPELLER

Water is drawn up by the impeller through these openings. The grate minimizes entry of foreign objects into the propulsion system.

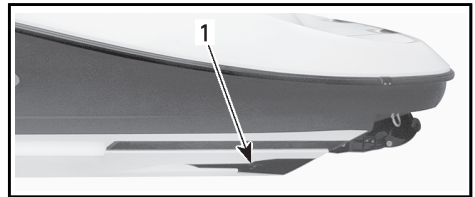

1. Intake grate

### ⚠ WARNING

Keep away from intake grates while engines are running. Items such as long hair, loose clothing or personal flotation device straps can become entangled in moving parts resulting in severe injury or drowning.

Weeds, shells or debris can get caught on the intake grates, drive

shafts and/or impellers. A clogged water intake may cause troubles such as:

1. **Cavitation:** Engine speed is high but boat moves slowly due to reduced jet thrust. Jet pump components may be damaged.
2. **Overheating:** Since the jet pump operation controls the flow of water to cool the exhaust system, a clogged intake will cause the engine to overheat and damage internal engine components.

### NOTICE

**Avoid operation in weeded areas. If unavoidable, vary speed. Weeds tend to entangle more at steady and slow speeds. Inspect water intake grates for damage. Refer to an authorized Rotax Jet Propulsion dealer for repair as necessary.**

### IN-WATER CLEANING

Pull the tether cord from engine cut-off switch to stop engine(s). Let the boat stop by itself. Wait a while to allow weeds or other debris to escape from grate(s). It may be necessary to repeat the procedure. In severe conditions if the above method does not work, the following can be performed:

1. With engine(s) running, put shifter lever in reverse position and vary throttle setting quickly several times.
2. Try accelerating again. Most of the time, debris will escape from the propulsion system. If not, refer to OUT OF WATER CLEANING.

### OUT OF WATER CLEANING

#### WARNING

**Keep away from intake grates while engines are running. Items such as long hair, loose clothing or personal flotation device straps can become entangled in moving parts resulting in severe injury or drowning.**

From underneath boat, manually clean water intakes area. If the system is still clogged, refer to an authorized boat dealer for servicing.

## IN THE WATER TOWING HOSE PINCHER INSTALLATION LOCATIONS

### NOTICE

Special precautions **MUST** be taken when towing a BRP Rotax powered boat in the water to prevent the exhaust system and engine from filling with water.

Maximum recommended towing speed is 24 km/h (15 MPH).

**IMPORTANT:** On models with twin engines, this procedure must be followed for both engines.

The cooling water supply hose to the inter-cooler (if applicable) and to the exhaust system **MUST** be pinched closed.

A Hose Pincher Tool, P/N 460717, is available for this purpose.

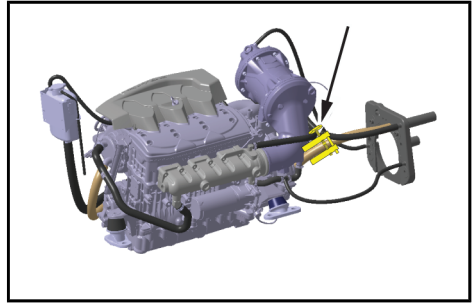

200 CAT ENGINES

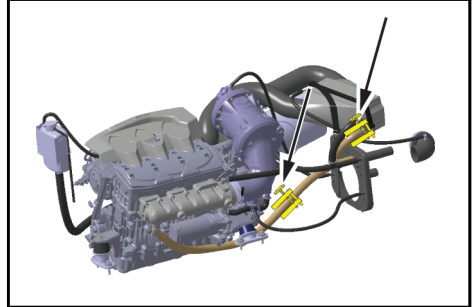

250 CAT ENGINES

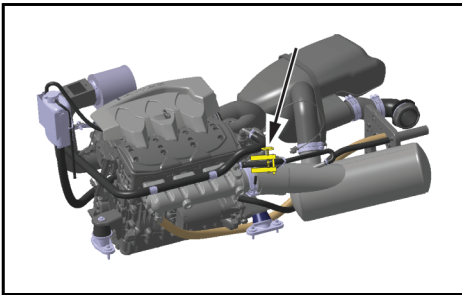

150 NON-CAT ENGINES

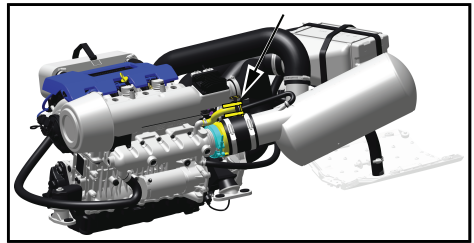

300 ENGINES

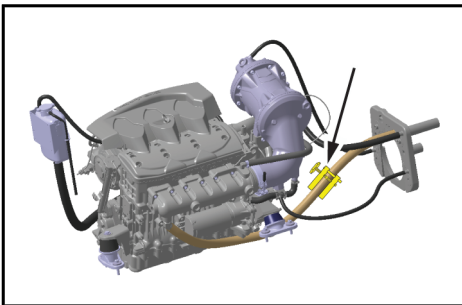

150 CAT ENGINES



This page is intentionally blank

[www.brp.com](http://www.brp.com)



**SKI-DOO®**

**LYNX®**

**SEA-DOO®**

**EVINRUDE®**

**CAN-AM®**

**ROTAX®**